

Grand & Toy

E60PQ-140003/045/PQ - GENERAL TERMS AND CONDITIONS

Pricing in the price guide is subject to change at any time.

The pricing herein will never exceed the Ceiling Price of the GoCUID as submitted to PSPC and as found in the Client Search Tool

Pricing does not include freight, delivery, installation, or applicable taxes

Please note the same GoCUID used in this price guide may be applicable for multiple products. The price shown is specific to the combination of components therein and may be shown below the Ceiling Price as found in the Client Search Tool.

Not all the product Grand & Toy has listed in the Client Search Tool may be included in the price guide. For additional product information and pricing please speak with your Government Sales Representative.

Due to different client needs the final specification of an item may not be shown with a price, please contact your Government Sales Representative for further details.

Due to different client needs and final furniture configurations, final pricing may differ than what is listed.

This price guide does not include information on the full range of available finishes. Please consult with the specific series price list, website, or your Government Sales Representative for full finish specifications.

Grand & Toy does not warrant the accuracy of different components when used in combination with other components if not verified by CAD layout, floor plan, and site measurement.

Images shown in this price guide are representative only. The actual product may differ based on size, orientation, configuration, and option selections.

For warranty, care, and installation instructions please visit the manufacturer's website, product series price list, or your Government Sales Representative

The Warranty and Terms of Service are per the manufacturer's standard manufacturing and operating policies. Where the terms and conditions of the RFSA differ from the published manufacturer policies, the RFSA will take precedence.

The price guide may be updated periodically, the most recent version can be made available on our website or by contacting your Government Sales Representative



Grand & Toy

E60PQ-140003/045/PQ - MODALITÉS ET CONDITIONS GÉNÉRALES

Les prix cités dans le guide des prix peuvent être modifiés en tout temps.

Le prix cité aux présentes ne sera jamais supérieur au prix plafond du CIUGdC soumis à SPAC et se trouvant dans l'Outil de recherche.

Les prix cités excluent les frais de transport, de livraison et d'installation ainsi que toute taxe applicable.

Veillez noter que le même CIUGdC utilisé dans ce guide des prix peut viser plusieurs produits. Le prix cité est propre à la combinaison particulière des composants du produit en question et peut être inférieur au prix plafond indiqué dans l'Outil de recherche.

Tous les produits Grand & Toy répertoriés dans l'Outil de recherche ne figurent pas nécessairement dans ce guide des prix. Pour de plus amples renseignements sur les produits et les prix, veuillez communiquer avec votre représentant des ventes gouvernementales.

En raison des besoins différents des clients et de la configuration finale du mobilier, le prix total peut différer de celui indiqué dans cette liste. Pour plus de détails, veuillez communiquer avec votre représentant des ventes gouvernementales.

Ce guide des prix ne contient pas des renseignements sur le choix complet de finis offerts. Pour des renseignements détaillés sur l'ensemble des finis, veuillez consulter la liste de prix de la gamme en question, le site Web ou votre représentant des ventes gouvernementales.

Grand & Toy ne garantit pas l'exactitude des différents composants lorsqu'ils sont utilisés en combinaison avec d'autres composants et s'ils ne sont pas validés selon le plan d'aménagement CAO, le plan d'étage et les mesures du site.

Les images figurant dans ce guide des prix sont présentées à titre indicatif uniquement. La taille, l'orientation, la configuration et les choix d'options du produit proprement dit peuvent différer.

Pour des renseignements complets sur la garantie et des instructions concernant l'entretien ou l'installation des produits, veuillez consulter le site Web du fabricant, la liste de prix de la gamme en question ou votre représentant des ventes gouvernementales.

La garantie et les conditions de service sont conformes aux politiques de fabrication et d'exploitation habituelles en vigueur du fabricant. Lorsque les modalités et conditions de la DAMA diffèrent des politiques publiées du fabricant, la DAMA aura préséance.

Le guide des prix peut être mis à jour périodiquement; vous pouvez toujours trouver la version la plus récente sur notre site Web ou en communiquant avec votre représentant des ventes gouvernementales.





Contact us for expert advice on all the products and services you need to create a productive workspace.

1.866.511.4534

furniture@grandandtoy.com

grandandtoy.com/gov

Communiquez avec nous pour obtenir des conseils éclairés sur tous les produits et services dont vous avez besoin pour créer un espace de travail productif.

1.866.511.4534

furniture@grandandtoy.com

grandandtoy.com/gouv

Grand & Toy

E60PQ-140003/045/PQ

CATEGORY 1A - INTERCONNECTING PANELS - BOULEVARD

APPLICATION NOTES / INSTRUCTIONS D'APPLICATION

- Used in conjunction with Category 1B work surfaces & component accessories
- SA Electrical and SA Hardware is specified separately
- Sizes indicated are baseline, additional height combinations available
- Utiliser avec les surfaces de travail et accessoires de la catégorie 1A
- Électricité et matériel de montage AMA doivent être spécifiés séparément
- Les dimensions indiquées sont des références, des combinaisons de hauteurs supplémentaires sont disponibles

SAMPLE APPLICATION / EXEMPLE D'APPLICATION

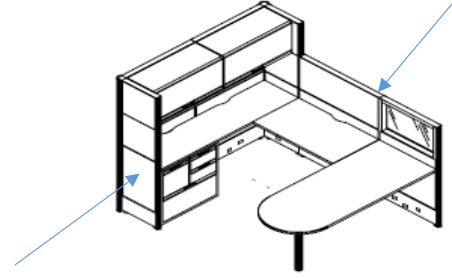

Frames - Base Height - Non Powered

Cadres - Hauteur de base - Non électrifié

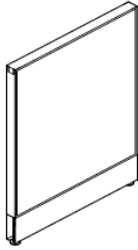

GoCUID / CIUGdC	Price / Prix	D/P	W/L	H	WT LB	CU
PAFRBHNP18	\$ 206.70	2.61	18	34	11	1.34
PAFRBHNP24	\$ 226.85	2.61	24	34	12	1.74
PAFRBHNP30	\$ 246.35	2.61	30	34	13	2.14
PAFRBHNP36	\$ 291.85	2.61	36	34	15	2.54
PAFRBHNP42	\$ 312.65	2.61	42	34	16	2.94
PAFRBHNP48	\$ 332.80	2.61	48	34	18	3.34
PAFRBHNP54	\$ 352.95	2.61	54	34	20	3.74
PAFRBHNP60	\$ 371.15	2.61	60	34	22	4.14

Frames - Base Height - Powered outlet(s) Below Work Surface

Cadres - Hauteur de base - Prise(s) électrique(s) en-dessous de la surface de travail

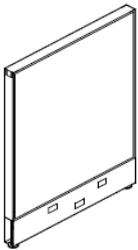

GoCUID / CIUGdC	Price / Prix	D/P	W/L	H	WT LB	CU
PAFRBHPB18	\$ 267.80	2.61	18	34	11	1.34
PAFRBHPB24	\$ 267.80	2.61	24	34	12	1.74
PAFRBHPB30	\$ 267.80	2.61	30	34	13	2.14
PAFRBHPB36	\$ 312.65	2.61	36	34	15	2.54
PAFRBHPB42	\$ 334.75	2.61	42	34	16	2.94
PAFRBHPB48	\$ 352.95	2.61	48	34	18	3.34
PAFRBHPB54	\$ 372.45	2.61	54	34	20	3.74
PAFRBHPB60	\$ 392.60	2.61	60	34	22	4.14

REQUIRED SPECIFICATIONS / SPÉCIFICATIONS REQUISES

- | | | | |
|----------------------|-----------------|--------------------------|-------------------------|
| - Frame/Cadre | Included/Inclus | - Hardware/Matériel | Not Included/Non inclus |
| - Fabric/Tissu | Included/Inclus | - Electrical/Électricité | Not Included/Non inclus |
| - Laminate/Stratifié | Included/Inclus | | |

Grand & Toy

E60PQ-140003/045/PQ

CATEGORY 1A - INTERCONNECTING PANELS - BOULEVARD

Frames - Base Height - Cut-out(s) for Power & Data, Fabric

Cadres - Hauteur de base - Cavité(s) pour insertion de prise(s) électrique(s) et données, Tissu

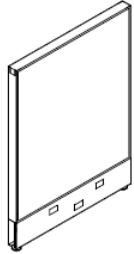

GoCUID / CIUGdC	Price / Prix	D/P	W/L	H	WT LB	CU
PAELBHCPDFA18	\$ 462.15	2.61	18	34	11	1.34
PAELBHCPDFA24	\$ 465.40	2.61	24	34	12	1.74
PAELBHCPDFA30	\$ 492.70	2.61	30	34	13	2.14
PAELBHCPDFA36	\$ 548.60	2.61	36	34	15	2.54
PAELBHCPDFA42	\$ 579.15	2.61	42	34	16	2.94
PAELBHCPDFA48	\$ 607.75	2.61	48	34	18	3.34
PAELBHCPDFA54	\$ 640.90	2.61	54	34	20	3.74
PAELBHCPDFA60	\$ 668.85	2.61	60	34	22	4.14

Frames - Base Height - Powered outlet(s) above the Work Surface

Cadres - Hauteur de base - Prise(s) électrique(s) au-dessus de la surface de travail

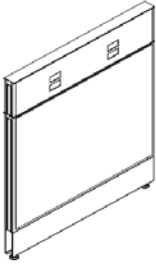

GoCUID / CIUGdC	Price / Prix	D/P	W/L	H	WT LB	CU
PAFRBHPW18	\$ 485.55	2.61	18	34	11	1.34
PAFRBHPW24	\$ 488.80	2.61	24	34	12	1.74
PAFRBHPW30	\$ 516.10	2.61	30	34	13	2.14
PAFRBHPW36	\$ 581.75	2.61	36	34	15	2.54
PAFRBHPW42	\$ 612.95	2.61	42	34	16	2.94
PAFRBHPW48	\$ 642.20	2.61	48	34	18	3.34
PAFRBHPW54	\$ 674.70	2.61	54	34	20	3.74
PAFRBHPW60	\$ 702.65	2.61	60	34	22	4.14

Frames - Base Height - Air Flow

Cadres - Hauteur de base - Aération

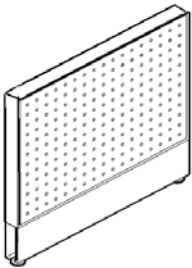

GoCUID / CIUGdC	Price / Prix	D/P	W/L	H	WT LB	CU
PAELBHxxxAF18	\$ 241.80	2.61	18	34	148	1.34
PAELBHxxxAF24	\$ 273.65	2.61	24	34	21	1.74
PAELBHxxxAF30	\$ 304.85	2.61	30	34	25	2.14
PAELBHxxxAF36	\$ 339.30	2.61	36	34	28	2.54
PAELBHxxxAF42	\$ 372.45	2.61	42	34	32	2.94
PAELBHxxxAF48	\$ 405.60	2.61	48	34	35	3.34
PAELBHxxxAF54	\$ 438.10	2.61	54	34	39	3.74
PAELBHxxxAF60	\$ 469.95	2.61	60	34	44	4.14

REQUIRED SPECIFICATIONS / SPÉCIFICATIONS REQUISES

- Frame/Cadre	Included/Inclus	- Hardware/Matériel	Not Included/Non inclus
- Fabric/Tissu	Included/Inclus	- Electrical/Électricité	Not Included/Non inclus
- Laminate/Stratifié	Included/Inclus		

Frames - Seated Privacy Height Add On - Non-Powered

Cadres - Panneau additionnel pour intimité en position assise - Non électrifié

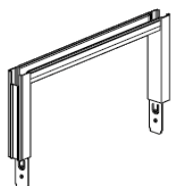

<i>GoCUID / CIUGdC</i>	<i>Price / Prix</i>	<i>D/P</i>	<i>W/L</i>	<i>H</i>	<i>WT LB</i>	<i>CU</i>
PAFRSANP18	\$ 126.75	2.61	18	16	3	0.38
PAFRSANP24	\$ 136.50	2.61	24	16	4	0.44
PAFRSANP30	\$ 148.20	2.61	30	16	4	0.66
PAFRSANP36	\$ 161.85	2.61	36	16	4	0.71
PAFRSANP42	\$ 175.50	2.61	42	16	5	0.88
PAFRSANP48	\$ 187.20	2.61	48	16	5	0.93
PAFRSANP54	\$ 198.90	2.61	54	16	6	1.04
PAFRSANP60	\$ 210.60	2.61	60	16	6	1.20

Frames - Seated Privacy Height Add On - Add-on with powered outlet(s)

Cadres - Panneau additionnel pour intimité en position assise - Panneau additionnel avec prise(s) électrique(s)

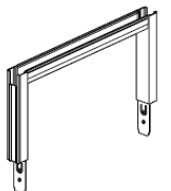

<i>GoCUID / CIUGdC</i>	<i>Price / Prix</i>	<i>D/P</i>	<i>W/L</i>	<i>H</i>	<i>WT LB</i>	<i>CU</i>
PAFRSAPA18	\$ 126.75	2.61	18	16	3	0.38
PAFRSAPA24	\$ 136.50	2.61	24	16	4	0.44
PAFRSAPA30	\$ 148.20	2.61	30	16	4	0.66
PAFRSAPA36	\$ 161.85	2.61	36	16	4	0.71
PAFRSAPA42	\$ 175.50	2.61	42	16	5	0.88
PAFRSAPA48	\$ 187.20	2.61	48	16	5	0.93
PAFRSAPA54	\$ 198.90	2.61	54	16	6	1.04
PAFRSAPA60	\$ 210.60	2.61	60	16	6	1.20

Frames - Work Surface Privacy Add On - Non-Powered

Cadres - Panneau additionnel pour intimité à la surface de travail - Non électrifié

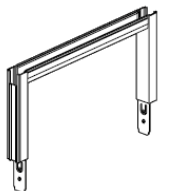

<i>GoCUID / CIUGdC</i>	<i>Price / Prix</i>	<i>D/P</i>	<i>W/L</i>	<i>H</i>	<i>WT LB</i>	<i>CU</i>
PAFRWANP18	\$ 84.50	2.61	18	8	3	0.38
PAFRWANP24	\$ 91.00	2.61	24	8	4	0.44
PAFRWANP30	\$ 98.80	2.61	30	8	4	0.66
PAFRWANP36	\$ 107.90	2.61	36	8	4	0.71
PAFRWANP42	\$ 117.00	2.61	42	8	5	0.88
PAFRWANP48	\$ 124.80	2.61	48	8	5	0.93
PAFRWANP54	\$ 132.60	2.61	54	8	6	1.04
PAFRWANP60	\$ 140.40	2.61	60	8	6	1.20

REQUIRED SPECIFICATIONS / SPÉCIFICATIONS REQUISES

- Frame/Cadre

Included/Inclus

- Hardware/Matériel

Not Included/Non inclus

- Electrical/Électricité

Not Included/Non inclus

Frames - Work Surface Privacy Add On - Add-on with powered outlet(s)

Cadres - Panneau additionnel pour intimité à la surface de travail - Panneau additionnel avec prise(s) électrique(s)

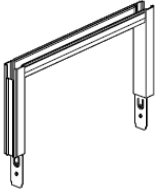

GoCUID / CIUGdC	Price / Prix	D/P	W/L	H	WT LB	CU
PAFRWAPA18	\$ 84.50	2.61	18	8	3	0.38
PAFRWAPA24	\$ 91.00	2.61	24	8	4	0.44
PAFRWAPA30	\$ 98.80	2.61	30	8	4	0.66
PAFRWAPA36	\$ 107.90	2.61	36	8	4	0.71
PAFRWAPA42	\$ 117.00	2.61	42	8	5	0.88
PAFRWAPA48	\$ 124.80	2.61	48	8	5	0.93
PAFRWAPA54	\$ 132.60	2.61	54	8	6	1.04
PAFRWAPA60	\$ 140.40	2.61	60	8	6	1.20

REQUIRED SPECIFICATIONS / SPÉCIFICATIONS REQUISES

- Frame Finish/Fini du cadre Included/Inclus - SA Hardware/Matériel AMA Not Included
 - SA Electrical/Électricité AMA Not Included

Elements - Accessory Rail

Tuiles - Rail d'accessoires

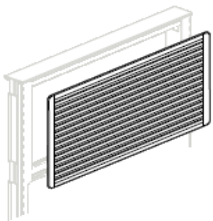

GoCUID / CIUGdC	Price / Prix	D/P	W/L	H	WT LB	CU
Seated Privacy Height / Panneau additionnel pour intimité en position assise						
PAELSAxxxAR18	\$ 140.40	0.25	18	16	2.5	0.29
PAELSAxxxAR24	\$ 167.70	0.25	24	16	4.7	0.33
PAELSAxxxAR30	\$ 181.35	0.25	30	16	5.7	0.42
PAELSAxxxAR36	\$ 217.10	0.25	36	16	7	0.50
PAELSAxxxAR42	\$ 259.35	0.25	42	16	8.2	0.58
PAELSAxxxAR48	\$ 301.60	0.25	48	16	9.4	0.67
PAELSAxxxAR54	\$ 325.65	0.25	54	16	10.6	0.00
PAELSAxxxAR60	\$ 369.85	0.25	60	16	11.9	0.75
						0.83
Work Surface Privacy Height/Panneau additionnel pour intimité à la surface de travail						
PAELWAxxxAR18	\$ 96.20	0.25	18	8	1.7	0.15
PAELWAxxxAR24	\$ 115.05	0.25	24	8	2.3	0.17
PAELWAxxxAR30	\$ 124.15	0.25	30	8	2.9	0.21
PAELWAxxxAR36	\$ 148.85	0.25	36	8	3.5	0.25
PAELWAxxxAR42	\$ 177.45	0.25	42	8	4.1	0.29
PAELWAxxxAR48	\$ 206.05	0.25	48	8	4.7	0.33
PAELWAxxxAR54	\$ 222.95	0.25	54	8	5.3	0.38
PAELWAxxxAR60	\$ 253.50	0.25	60	8	5.9	0.42

* Specify one (1) element per panel frame side

* Spécifiez une tuile par côté

REQUIRED SPECIFICATIONS / SPÉCIFICATIONS REQUISES

- Frame/Cadre

Included/Inclus

Elements - Cut-out(s) for Power & Data, Fabric

Tuiles - Cavit (s) pour insertion de prise(s)  lectrique(s) et donn es, Tissu

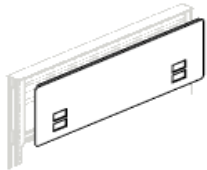

GoCUID / CIUGdC	Price / Prix	D/P	W/L	H	WT LB	CU
Seated Privacy Height / Panneau additionnel pour intimit� en position assise						
PAELSACPDFA18	\$ 189.80	0.125	18	16	2	0.30
PAELSACPDFA24	\$ 195.65	0.125	24	16	2.5	0.34
PAELSACPDFA30	\$ 219.70	0.125	30	16	3	0.42
PAELSACPDFA36	\$ 254.15	0.125	36	16	3	0.50
PAELSACPDFA42	\$ 267.15	0.125	42	16	3	0.58
PAELSACPDFA48	\$ 275.60	0.125	48	16	4	0.67
PAELSACPDFA54	\$ 288.60	0.125	54	16	4	0.75
PAELSACPDFA60	\$ 297.05	0.125	60	16	5	0.83

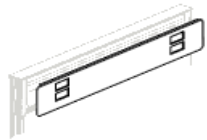

GoCUID / CIUGdC	Price / Prix	D/P	W/L	H	WT LB	CU
Work Surface Privacy Height/Panneau additionnel pour intimit� � la surface de travail						
PAELWACPDFA18	\$ 144.95	0.25	18	8	1.7	0.15
PAELWACPDFA24	\$ 147.55	0.25	24	8	2.3	0.17
PAELWACPDFA30	\$ 165.75	0.25	30	8	2.9	0.21
PAELWACPDFA36	\$ 189.15	0.25	36	8	3.5	0.25
PAELWACPDFA42	\$ 198.25	0.25	42	8	4.1	0.29
PAELWACPDFA48	\$ 204.10	0.25	48	8	4.7	0.33
PAELWACPDFA54	\$ 212.55	0.25	54	8	5.3	0.38
PAELWACPDFA60	\$ 219.05	0.25	60	8	5.9	0.42

Elements - Cut-out(s) for Power & Data, Tackable Surface

Tuiles - Cavit (s) pour insertion de prise(s)  lectrique(s) et donn es, Surface punaisable

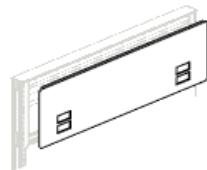

GoCUID / CIUGdC	Price / Prix	D/P	W/L	H	WT LB	CU
Seated Privacy Height / Panneau additionnel pour intimit� en position assise						
PAELSACPDTB18	\$ 189.80	0.125	18	16	2	0.30
PAELSACPDTB24	\$ 195.65	0.125	24	16	2.5	0.34
PAELSACPDTB30	\$ 219.70	0.125	30	16	3	0.42
PAELSACPDTB36	\$ 254.15	0.125	36	16	3	0.50
PAELSACPDTB42	\$ 267.15	0.125	42	16	3	0.58
PAELSACPDTB48	\$ 275.60	0.125	48	16	4	0.67
PAELSACPDTB54	\$ 288.60	0.125	54	16	4	0.75
PAELSACPDTB60	\$ 297.05	0.125	60	16	5	0.83

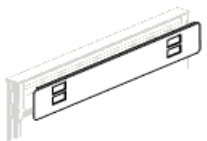

GoCUID / CIUGdC	Price / Prix	D/P	W/L	H	WT LB	CU
Work Surface Privacy Height/Panneau additionnel pour intimit� � la surface de travail						
PAELWACPDTB18	\$ 144.95	0.25	18	8	1.7	0.15
PAELWACPDTB24	\$ 147.55	0.25	24	8	2.3	0.17
PAELWACPDTB30	\$ 165.75	0.25	30	8	2.9	0.21
PAELWACPDTB36	\$ 189.15	0.25	36	8	3.5	0.25
PAELWACPDTB42	\$ 198.25	0.25	42	8	4.1	0.29
PAELWACPDTB48	\$ 204.10	0.25	48	8	4.7	0.33
PAELWACPDTB54	\$ 212.55	0.25	54	8	5.3	0.38
PAELWACPDTB60	\$ 219.05	0.25	60	8	5.9	0.42

Grand & Toy

E60PQ-140003/045/PQ

CATEGORY 1A - INTERCONNECTING PANELS - BOULEVARD

* Specify one (1) element per panel frame side

* Spécifier une tuile par côté

REQUIRED SPECIFICATIONS / SPÉCIFICATIONS REQUISES

- Fabric/Tissu

Included/Inclus

Elements - Cut-out(s) for Power, Fabric

Tuiles - Cavité(s) pour insertion de prise(s) électrique(s), Tissu

GoCUID / CIUGdC **Price / Prix** **D/P** **W/L** **H** **WT LB** **CU**

Seated Privacy Height / Panneau additionnel pour intimité en position assise

PAELSACPxFA18	\$ 189.80	0.125	18	16	2	0.30
PAELSACPxFA24	\$ 195.65	0.125	24	16	2.5	0.34
PAELSACPxFA30	\$ 219.70	0.125	30	16	3	0.42
PAELSACPxFA36	\$ 254.15	0.125	36	16	3	0.50
PAELSACPxFA42	\$ 267.15	0.125	42	16	3	0.58
PAELSACPxFA48	\$ 275.60	0.125	48	16	4	0.67
PAELSACPxFA54	\$ 288.60	0.125	54	16	4	0.75
PAELSACPxFA60	\$ 297.05	0.125	60	16	5	0.83

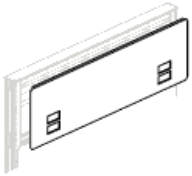

Work Surface Privacy Height/Panneau additionnel pour intimité à la surface de travail

PAELWACPxFA18	\$ 144.95	0.25	18	8	1.7	0.15
PAELWACPxFA24	\$ 147.55	0.25	24	8	2.3	0.17
PAELWACPxFA30	\$ 165.75	0.25	30	8	2.9	0.21
PAELWACPxFA36	\$ 189.15	0.25	36	8	3.5	0.25
PAELWACPxFA42	\$ 198.25	0.25	42	8	4.1	0.29
PAELWACPxFA48	\$ 204.10	0.25	48	8	4.7	0.33
PAELWACPxFA54	\$ 212.55	0.25	54	8	5.3	0.38
PAELWACPxFA60	\$ 219.05	0.25	60	8	5.9	0.42

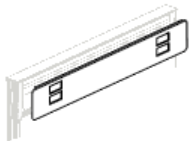

Elements - Cut-out(s) for Power, Tackable Surface

Tuiles - Cavité(s) pour insertion de prise(s) électrique(s), Surface punaisable

GoCUID / CIUGdC **Price / Prix** **D/P** **W/L** **H** **WT LB** **CU**

Seated Privacy Height / Panneau additionnel pour intimité en position assise

PAELSACPxB18	\$ 189.80	0.125	18	16	2	0.30
PAELSACPxB24	\$ 195.65	0.125	24	16	2.5	0.34
PAELSACPxB30	\$ 219.70	0.125	30	16	3	0.42
PAELSACPxB36	\$ 254.15	0.125	36	16	3	0.50
PAELSACPxB42	\$ 267.15	0.125	42	16	3	0.58
PAELSACPxB48	\$ 275.60	0.125	48	16	4	0.67
PAELSACPxB54	\$ 288.60	0.125	54	16	4	0.75
PAELSACPxB60	\$ 297.05	0.125	60	16	5	0.83

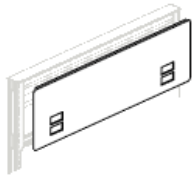

Work Surface Privacy Height/Panneau additionnel pour intimité à la surface de travail

PAELWACPxB18	\$ 144.95	0.25	18	8	1.7	0.15
PAELWACPxB24	\$ 147.55	0.25	24	8	2.3	0.17
PAELWACPxB30	\$ 165.75	0.25	30	8	2.9	0.21
PAELWACPxB36	\$ 189.15	0.25	36	8	3.5	0.25
PAELWACPxB42	\$ 198.25	0.25	42	8	4.1	0.29
PAELWACPxB48	\$ 204.10	0.25	48	8	4.7	0.33
PAELWACPxB54	\$ 212.55	0.25	54	8	5.3	0.38

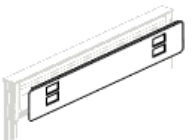

Grand & Toy

E60PQ-140003/045/PQ

CATEGORY 1A - INTERCONNECTING PANELS - BOULEVARD

PAELWACPxB60	\$ 219.05	0.25	60	8	5.9	0.42
--------------	-----------	------	----	---	-----	------

* Specify one (1) element per panel frame side

* Spécifiez une tuile par côté

REQUIRED SPECIFICATIONS / SPÉCIFICATIONS REQUISES

- Fabric/Tissu

Included/Inclus

Elements - Fabric

Tuiles- Tissu

GoCUID / CIUGdC Price / Prix D/P W/L H WT LB CU

Seated Privacy Height / Panneau additionnel pour intimité en position assise

PAELSAxxxFA18	\$ 139.75	0.25	18	16	2	0.29
PAELSAxxxFA24	\$ 148.85	0.25	24	16	2	0.33
PAELSAxxxFA30	\$ 167.05	0.25	30	16	3	0.42
PAELSAxxxFA36	\$ 200.85	0.25	36	16	3	0.50
PAELSAxxxFA42	\$ 213.85	0.25	42	16	3	0.58
PAELSAxxxFA48	\$ 222.30	0.25	48	16	4	0.67
PAELSAxxxFA54	\$ 234.65	0.25	54	16	4	0.75
PAELSAxxxFA60	\$ 241.80	0.25	60	16	5	0.83

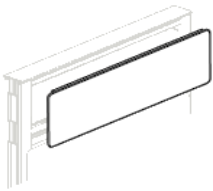

Work Surface Privacy Height/Panneau additionnel pour intimité à la surface de travail

PAELWAxxxFA18	\$ 94.90	0.25	18	8	1.7	0.15
PAELWAxxxFA24	\$ 100.75	0.25	24	8	2.3	0.17
PAELWAxxxFA30	\$ 113.10	0.25	30	8	2.9	0.21
PAELWAxxxFA36	\$ 135.85	0.25	36	8	3.5	0.25
PAELWAxxxFA42	\$ 144.95	0.25	42	8	4.1	0.29
PAELWAxxxFA48	\$ 150.80	0.25	48	8	4.7	0.33
PAELWAxxxFA54	\$ 158.60	0.25	54	8	5.3	0.38
PAELWAxxxFA60	\$ 163.80	0.25	60	8	5.9	0.42

* Specify one (1) element per panel frame side

* Spécifier une tuile par côté

REQUIRED SPECIFICATIONS / SPÉCIFICATIONS REQUISES

- Fabric/Tissu

Included/Inclus

Elements - Frosted Glazed (Includes Frame and Glazing)

Tuiles - Cloison en verre givré (comprend le cadre et la vitre)

GoCUID / CIUGdC Price / Prix D/P W/L H WT LB CU

Seated Privacy Height / Panneau additionnel pour intimité en position assise

PAELSAxxxFG18	\$ 123.50	2.61	18	16	4.3	0.29
PAELSAxxxFG24	\$ 165.75	2.61	24	16	5.8	0.33
PAELSAxxxFG30	\$ 209.30	2.61	30	16	7.2	0.42
PAELSAxxxFG36	\$ 256.10	2.61	36	16	8.7	0.50
PAELSAxxxFG42	\$ 299.00	2.61	42	16	10.2	0.58
PAELSAxxxFG48	\$ 342.55	2.61	48	16	11.6	0.67
PAELSAxxxFG54	\$ 388.05	2.61	54	16	13.1	0.75
PAELSAxxxFG60	\$ 431.60	2.61	60	16	14.6	0.83

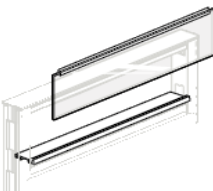

Grand & Toy

E60PQ-140003/045/PQ

CATEGORY 1A - INTERCONNECTING PANELS - BOULEVARD

* Specify one (1) element per panel

*Spécifier une tuile par panneau

REQUIRED SPECIFICATIONS / SPÉCIFICATIONS REQUISES

- Glazing/Vitrage Included/Inclus

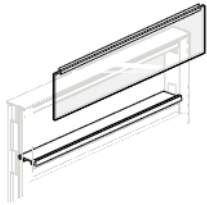

GoCUID / CIUGdC	Price / Prix	D/P	W/L	H	WT LB	CU
Work Surface Privacy Height/Panneau additionnel pour intimité à la surface de travail						
PAELWAxxxFG18	\$ 84.50	2.61	18	8	2.3	0.15
PAELWAxxxFG24	\$ 113.75	2.61	24	8	3.1	0.17
PAELWAxxxFG30	\$ 143.65	2.61	30	8	3.9	0.20
PAELWAxxxFG36	\$ 175.50	2.61	36	8	4.7	0.25
PAELWAxxxFG42	\$ 204.75	2.61	42	8	5.5	0.29
PAELWAxxxFG48	\$ 234.65	2.61	48	8	6.3	0.33
PAELWAxxxFG54	\$ 265.85	2.61	54	8	7.1	0.38
PAELWAxxxFG60	\$ 295.75	2.61	60	8	7.8	0.42

* Specify one (1) element per panel

*Spécifier une tuile par panneau

REQUIRED SPECIFICATIONS / SPÉCIFICATIONS REQUISES

- Glazing/Vitrage Included/Inclus

Elements - Tackable Surface

Tuiles - Surface punaisable

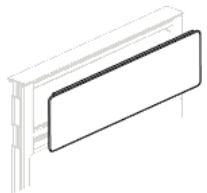

GoCUID / CIUGdC	Price / Prix	D/P	W/L	H	WT LB	CU
Seated Privacy Height / Panneau additionnel pour intimité en position assise						
PAELSAxxxTB18	\$ 139.75	0.25	18	16	2	0.29
PAELSAxxxTB24	\$ 148.85	0.25	24	16	2	0.33
PAELSAxxxTB30	\$ 167.05	0.25	30	16	3	0.42
PAELSAxxxTB36	\$ 200.85	0.25	36	16	3	0.50
PAELSAxxxTB42	\$ 213.85	0.25	42	16	3	0.58
PAELSAxxxTB48	\$ 222.30	0.25	48	16	4	0.67
PAELSAxxxTB54	\$ 234.65	0.25	54	16	4	0.75
PAELSAxxxTB60	\$ 241.80	0.25	60	16	5	0.83
Work Surface Privacy Height/Panneau additionnel pour intimité à la surface de travail						
PAELWAxxxTB18	\$ 94.90	0.25	18	8	1.7	0.15
PAELWAxxxTB24	\$ 100.75	0.25	24	8	2.3	0.17
PAELWAxxxTB30	\$ 113.10	0.25	30	8	2.9	0.21
PAELWAxxxTB36	\$ 135.85	0.25	36	8	3.5	0.25
PAELWAxxxTB42	\$ 144.95	0.25	42	8	4.1	0.29
PAELWAxxxTB48	\$ 150.80	0.25	48	8	4.7	0.33
PAELWAxxxTB54	\$ 158.60	0.25	54	8	5.3	0.38
PAELWAxxxTB60	\$ 163.80	0.25	60	8	5.9	0.42

* Specify one (1) element per panel frame side

* Spécifier une tuile par côté

REQUIRED SPECIFICATIONS / SPÉCIFICATIONS REQUISES

- Fabric/Tissu Included/Inclus

Elements - White Board
Tuiles - Tableau blanc

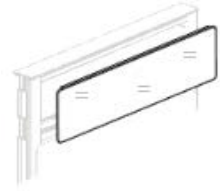

<i>GoCUID / CIUGdC</i>	<i>Price / Prix</i>	<i>D/P</i>	<i>W/L</i>	<i>H</i>	<i>WT LB</i>	<i>CU</i>
<i>Seated Privacy Height / Panneau additionnel pour intimité en position assise</i>						
PAELSAxxxWB18	\$ 150.80	0.25	18	16	2	0.29
PAELSAxxxWB24	\$ 158.60	0.25	24	16	2	0.33
PAELSAxxxWB30	\$ 187.20	0.25	30	16	3	0.42
PAELSAxxxWB36	\$ 221.00	0.25	36	16	3	0.50
PAELSAxxxWB42	\$ 234.65	0.25	42	16	3	0.58
PAELSAxxxWB48	\$ 243.10	0.25	48	16	4	0.67
PAELSAxxxWB54	\$ 254.80	0.25	54	16	4	0.75
PAELSAxxxWB60	\$ 261.95	0.25	60	16	5	0.83
<i>Work Surface Privacy Height/Panneau additionnel pour intimité à la surface de travail</i>						
PAELWAxxxWB18	\$ 102.05	0.25	18	8	1.7	0.15
PAELWAxxxWB24	\$ 107.25	0.25	24	8	2.3	0.17
PAELWAxxxWB30	\$ 126.75	0.25	30	8	2.9	0.21
PAELWAxxxWB36	\$ 149.50	0.25	36	8	3.5	0.25
PAELWAxxxWB42	\$ 158.60	0.25	42	8	4.1	0.29
PAELWAxxxWB48	\$ 164.45	0.25	48	8	4.7	0.33
PAELWAxxxWB54	\$ 172.25	0.25	54	8	5.3	0.38
PAELWAxxxWB60	\$ 177.45	0.25	60	8	5.9	0.42

* Specify one (1) element per panel frame side
* Spécifier une tuile par côté

Grand & Toy

E60PQ-140003/045/PQ

CATEGORY 1A - INTERCONNECTING PANELS - BOULEVARD

APPLICATION NOTES / INSTRUCTIONS D'APPLICATION

- Used with Category 1A panels
- Panel mounted privacy screens may be embedded or attached to top trim
- Panel mounted privacy screens must match surface and seated privacy panel height
- Height is the glass pane portion only
- All mounting hardware included

- Utiliser avec les panneaux de la catégorie 1A
- Les écrans d'intimité montés sur panneau peuvent être intégrés au panneau ou montés à la garniture supérieure
- Les écrans d'intimité montés sur panneau doivent correspondre à la hauteur du panneau d'intimité (assis ou surface de travail)
- La hauteur est la partie vitrée seulement
- Tout le matériel de montage est inclus

SAMPLE APPLICATION / EXEMPLE D'APPLICATION

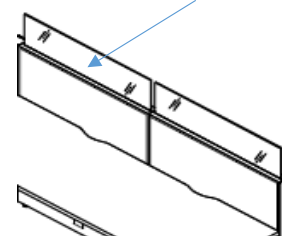

Component System Accessories - Privacy Screens - Panel Mounted - Frosted Glass
 Accessoires - Écrans d'intimité - Montage sur panneau - Verre givré

Embedded - Frosted / Intégré - Givré

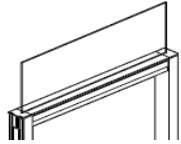

GoCUID / CIUGdC	Price / Prix	D/P	W/L	H	WT LB	CU
1bCPSXXNXXL24XFRN NN	\$ 240.50	2.61	24	8	10	1.17
1bCPSXXNXXL30XFRN NN	\$ 245.70	2.61	30	8	12	1.68
1bCPSXXNXXL36XFRN NN	\$ 252.85	2.61	36	8	13	1.92
1bCPSXXNXXL42XFRN NN	\$ 263.25	2.61	42	8	15	2.31
1bCPSXXNXXL48XFRN NN	\$ 275.60	2.61	48	8	17	2.51
1bCPSXXNXXL54XFRN NN	\$ 295.75	2.61	54	8	19	2.84
1bCPSXXNXXL24XFRN NN	\$ 279.50	2.61	24	16	11	1.67
1bCPSXXNXXL30XFRN NN	\$ 287.95	2.61	30	16	13	2.18
1bCPSXXNXXL36XFRN NN	\$ 298.35	2.61	36	16	14	2.42
1bCPSXXNXXL42XFRN NN	\$ 312.00	2.61	42	16	16	2.81
1bCPSXXNXXL48XFRN NN	\$ 327.60	2.61	48	16	18	3.01
1bCPSXXNXXL54XFRN NN	\$ 351.00	2.61	54	16	20	3.34

- * Must be ordered same time as panel to ensure accurate fittings
- * Doit être commandé en même temps que le panneau pour assurer des raccords précis

REQUIRED SPECIFICATIONS / SPÉCIFICATIONS REQUISES

- Frame/Cadre Included/Inclus

Top Trim Mounted - Frosted / Montage à la garniture supérieure - Givré

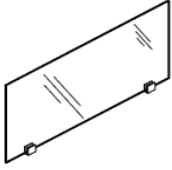

GoCUID / CIUGdC	Price / Prix	D/P	W/L	H	WT LB	CU
1bCPSXXNXXL24XFRNNN	\$ 112.45	1.3	24	8	4	0.22
1bCPSXXNXXL30XFRNNN	\$ 124.80	1.3	30	8	5	0.30
1bCPSXXNXXL36XFRNNN	\$ 135.20	1.3	36	8	6	0.37
1bCPSXXNXXL42XFRNNN	\$ 145.60	1.3	42	8	7	0.43
1bCPSXXNXXL48XFRNNN	\$ 152.75	1.3	48	8	8	0.48
1bCPSXXNXXL24XFRNNN	\$ 119.60	1.3	24	16	8	0.44
1bCPSXXNXXL30XFRNNN	\$ 131.95	1.3	30	16	10	0.59
1bCPSXXNXXL36XFRNNN	\$ 141.70	1.3	36	16	12	0.73
1bCPSXXNXXL42XFRNNN	\$ 152.10	1.3	42	16	14	0.85
1bCPSXXNXXL48XFRNNN	\$ 159.90	1.3	48	16	16	0.96

Component System Accessories - Privacy Screens - Panel Mounted - Clear Glass
Accessoires - Écrans d'intimité - Montage sur panneau - Verre transparent

Embedded - Clear / Intégré - Verre transparent

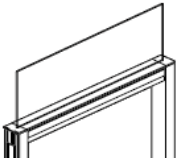

GoCUID / CIUGdC	Price / Prix	D/P	W/L	H	WT LB	CU
1bCPSXXNXXL24XCLNNN	\$ 240.50	2.61	24	8	10	1.17
1bCPSXXNXXL30XCLNNN	\$ 245.70	2.61	30	8	12	1.68
1bCPSXXNXXL36XCLNNN	\$ 252.85	2.61	36	8	13	1.92
1bCPSXXNXXL42XCLNNN	\$ 263.25	2.61	42	8	15	2.31
1bCPSXXNXXL48XCLNNN	\$ 275.60	2.61	48	8	17	2.51
1bCPSXXNXXL54XCLNNN	\$ 295.75	2.61	54	8	19	2.84
1bCPSXXNXXL24XCLNNN	\$ 279.50	2.61	24	16	11	1.67
1bCPSXXNXXL30XCLNNN	\$ 287.95	2.61	30	16	13	2.18
1bCPSXXNXXL36XCLNNN	\$ 298.35	2.61	36	16	14	2.42
1bCPSXXNXXL42XCLNNN	\$ 312.00	2.61	42	16	16	2.81
1bCPSXXNXXL48XCLNNN	\$ 327.60	2.61	48	16	18	3.01
1bCPSXXNXXL54XCLNNN	\$ 351.00	2.61	54	16	20	3.34

* Must be ordered same time as panel to ensure accurate fittings

* Doit être commandé en même temps que le panneau pour assurer des raccords précis

REQUIRED SPECIFICATIONS / SPÉCIFICATIONS REQUISES

- Frame/Cadre Included/Inclus

Grand & Toy

E60PQ-140003/045/PQ

CATEGORY 1B - PRIVACY SCREENS - BOULEVARD

Top Trim Mounted - Clear / Montage à la garniture supérieure - Verre transparent

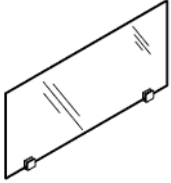

<i>GoCUID / CIUGdC</i>	<i>Price / Prix</i>	<i>D/P</i>	<i>W/L</i>	<i>H</i>	<i>WT LB</i>	<i>CU</i>
1bCPSXXNXXL24XCLNNN	\$ 98.80	1.3	24	8	4	0.22
1bCPSXXNXXL30XCLNNN	\$ 109.85	1.3	30	8	5	0.30
1bCPSXXNXXL36XCLNNN	\$ 118.30	1.3	36	8	6	0.37
1bCPSXXNXXL42XCLNNN	\$ 124.80	1.3	42	8	7	0.43
1bCPSXXNXXL48XCLNNN	\$ 134.55	1.3	48	8	8	0.48
1bCPSXXNXXL24XCLNNN	\$ 105.95	1.3	24	16	8	0.44
1bCPSXXNXXL30XCLNNN	\$ 117.00	1.3	30	16	10	0.59
1bCPSXXNXXL36XCLNNN	\$ 123.50	1.3	36	16	12	0.73
1bCPSXXNXXL42XCLNNN	\$ 131.95	1.3	42	16	14	0.85
1bCPSXXNXXL48XCLNNN	\$ 135.20	1.3	48	16	16	0.96

Grand & Toy

E60PQ-140003/045/PQ

CATEGORY 1B - PRIVACY SCREENS - BOULEVARD

APPLICATION NOTES / INSTRUCTIONS D'APPLICATION

- Used with Category 1B, 2, 4, & 6 surface applications
- Work surface privacy available in Fabric or Frosted
- Work surface privacy panels must be between 12" and 16" in height
- Work surface privacy panels must extend minimum 6" below the work surface
- Work surface privacy panels must be corresponding surface width
- Utiliser avec les surface des catégories 1B, 2, 4 et 6
- Les écrans d'intimité fixées sur la surface de travail sont disponibles en tissu ou en verre givré
- Les écrans d'intimité fixées sur la surface de travail doivent avoir une hauteur comprise entre 12 po et 16 po
- Le écrans d'intimité fixées sur la surface de travail doivent être au moins 6 po sous la surface de travail
- Les écrans d'intimité fixées sur la surface de travail doivent avoir la même largeur que la surface de travail

SAMPLE APPLICATION / EXEMPLE D'APPLICATION

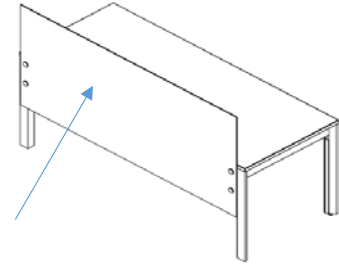

Component System Accessories - Privacy Screens - Work Surface Mounted - Fabric
Accessoires - Écrans d'intimité - Fixée sur la surface de travail - Tissu

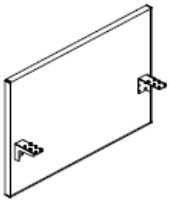

GoCUID / CIUGdC	Price / Prix	D/P	W/L	H	WT LB	CU
1bCPSXXSXXL24XFANNN	\$ 218.05	1.25	24	30	18	1.43
1bCPSXXSXXL30XFANNN	\$ 218.05	1.25	30	30	20	1.73
1bCPSXXSXXL36XFANNN	\$ 260.05	1.25	36	30	22	2.03
1bCPSXXSXXL42XFANNN	\$ 291.80	1.25	42	30	25	2.34
1bCPSXXSXXL48XFANNN	\$ 323.55	1.25	48	30	27	2.66
1bCPSXXSXXL54XFANNN	\$ 365.55	1.25	54	30	30	2.97

REQUIRED SPECIFICATIONS / SPÉCIFICATIONS REQUISES

- Fabric / Tissu Gr. 1 Included/Inclus
- Metal Painted Frame / Cadre en métal peint Included/Inclus

ADDITIONAL OPTIONS / OPTIONS ADDITIONELLES

- Fabric / Tissu Gr. 2 : 24" - 36" \$ 14.95
- Fabric / Tissu Gr. 2 : 42" \$ 18.20
- Fabric / Tissu Gr. 2 : 48" - 54" \$ 21.45

Component System Accessories - Privacy Screens - Work Surface Mounted - Frosted Glass
Accessoires - Écrans d'intimité - Fixée sur la surface de travail - Verre givré

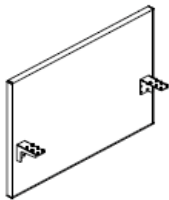

GoCUID / CIUGdC	Price / Prix	D/P	W/L	H	WT LB	CU
1bCPSXXSXXL24XFRNNN	\$ 319.15	1.25	24	30	19	0.14
1bCPSXXSXXL30XFRNNN	\$ 319.15	1.25	30	30	23	0.16
1bCPSXXSXXL36XFRNNN	\$ 349.70	1.25	36	30	27	0.18
1bCPSXXSXXL42XFRNNN	\$ 380.25	1.25	42	30	31	0.20
1bCPSXXSXXL48XFRNNN	\$ 410.15	1.25	48	30	35	0.23
1bCPSXXSXXL54XFRNNN	\$ 440.05	1.25	54	30	39	0.25

Grand & Toy

E60PQ-140003/045/PQ

CATEGORY 1B - PRIVACY SCREENS - BRIDGES

APPLICATION NOTES / INSTRUCTIONS D'APPLICATION



- Used in conjunction with Category 1A panel application
- When used against a panel or wall a modesty is not required
- When used perpendicular to a panel or wall a modesty must be specified
- All hardware and supporting brackets are to be specified separately
- No other specification options are available for this product
- **Items marked with a " * " are an extended lead time of 6 weeks**

- Utiliser avec les panneaux de la catégorie 1A
- Lorsqu'utilisé contre un panneau ou un mur, le panneau de modestie n'est pas requis
- Lorsqu'utilisé perpendiculaire à un panneau ou à un mur, le panneau de modestie doit être spécifié
- Tout le matériel et les supports doivent être spécifiés séparément
- Aucune autre option de spécification n'est disponible pour ce produit.
- **Les articles marqués d'un " * " ont un délai de production de 6 semaines**

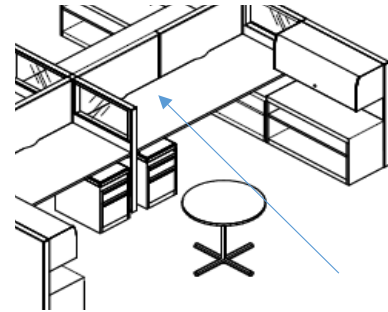
SAMPLE APPLICATION / EXEMPLE D'APPLICATION

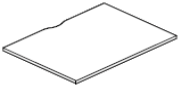

Free Standing Systems - Fixed Height Work Surfaces (Laminate) - Rectangular - Panel Mounted
 Systèmes autoportants - Surfaces de travail à hauteur fixe (stratifié) - Rectangulaire - Montée sur panneau

	GoCUID / CIUGdC	Price / Prix	D/P	W/L	H	WT LB	CU
 Worksurfaces 48" or Less Surfaces de travail de 48 po ou moins	1bFFHREN24L30WNOLNY	\$ 85.15	24	30	1	20	0.65
	1bFFHREN24L36WNOLNY	\$ 96.85	24	36	1	23	0.78
	1bFFHREN24L42WNOLNY	\$ 126.75	24	42	1	28	0.90
	1bFFHREN24L48WNOLNY	\$ 152.75	24	48	1	31	1.03
	1bFFHREN24L54WNOLNY	\$ 178.10	24	54	1	35	1.20
	1bFFHREN24L60WNOLNY	\$ 200.85	24	60	1	39	1.30
	1bFFHREN24L66WNOLNY	\$ 209.30	24	66	1	43	1.41
	1bFFHREN24L72WNOLNY	\$ 219.05	24	72	1	47	1.54
	1bFFHREN24L78WNOLNY	\$ 233.35	24	78	1	51	1.70
	1bFFHREN24L84WNOLNY	\$ 250.90	24	84	1	55	1.80
 Worksurfaces 54" or Longer Surfaces de travail de 54 po ou plus	1bFFHREN30L30WNOLNY	\$ 101.40	30	30	1	25	0.97
	1bFFHREN30L36WNOLNY	\$ 119.60	30	36	1	30	1.06
	1bFFHREN30L42WNOLNY	\$ 169.00	30	42	1	34	1.12
	1bFFHREN30L48WNOLNY	\$ 178.10	30	48	1	39	1.30
	1bFFHREN30L54WNOLNY	\$ 190.45	30	54	1	44	1.44
	1bFFHREN30L60WNOLNY	\$ 209.30	30	60	1	49	1.60
	1bFFHREN30L66WNOLNY	\$ 218.40	30	66	1	54	1.80
	1bFFHREN30L72WNOLNY	\$ 230.75	30	72	1	59	2.00
	1bFFHREN30L78WNOLNY	\$ 243.75	30	78	1	64	2.10
	1bFFHREN30L84WNOLNY	\$ 270.40	30	84	1	69	2.24

REQUIRED SPECIFICATIONS / SPÉCIFICATIONS REQUISES

- Laminate / Stratifié Included/Inclus

Free Standing Systems - Fixed Height Work Surfaces (Laminate) - Transitional - Panel Mounted

Systèmes autoportants - Surfaces de travail à hauteur fixe (stratifié) - Transitionnelle - Montée sur panneau

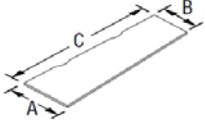

<i>GoCUID / CIUGdC</i>	<i>Price / Prix</i>	<i>D/P</i>	<i>W/L</i>	<i>H</i>	<i>WT</i>	<i>CU</i>
1bFFHTNNTRL30WNOLNY	\$ 202.15	24-30	30	1	24	0.42
1bFFHTNNTRL36WNOLNY	\$ 202.15	24-30	36	1	29	0.52
1bFFHTNNTRL42WNOLNY	\$ 202.15	24-30	42	1	33	0.63
1bFFHTNNTRL48WNOLNY	\$ 202.15	24-30	48	1	38	0.73
1bFFHTNNTRL54WNOLNY	\$ 226.85	24-30	54	1	42	0.84
1bFFHTNNTRL60WNOLNY	\$ 252.85	24-30	60	1	47	0.94
1bFFHTNNTRL66WNOLNY	\$ 276.90	24-30	66	1	51	1.03
1bFFHTNNTRL72WNOLNY	\$ 302.25	24-30	72	1	56	1.13
1bFFHTNNTRL78WNOLNY	\$ 319.15	24-30	78	1	61	1.24
1bFFHTNNTRL84WNOLNY	\$ 353.60	24-30	84	1	65	1.34

* GoCUID is generic to size and shape but not specific to orientation. Please specify accordingly

* GoCUID est générique pour la taille et la forme mais pas spécifique pour l'orientation. Veuillez spécifier en conséquence

Free Standing Systems - Fixed Height Work Surfaces (Laminate) - D-Top - Panel Mounted

Systèmes autoportants - Surfaces de travail à hauteur fixe (stratifié) - en D - Montée sur panneau

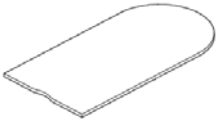

<i>GoCUID / CIUGdC</i>	<i>Price / Prix</i>	<i>D/P</i>	<i>W/L</i>	<i>H</i>	<i>WT</i>	<i>CU</i>
1bFFHDTN24L60WNOLNY	\$ 241.80	24	60	1	32	1.21
1bFFHDTN24L66WNOLNY	\$ 254.15	24	66	1	36	1.34
1bFFHDTN24L72WNOLNY	\$ 265.20	24	72	1	40	1.46
1bFFHDTN30L60WNOLNY	\$ 265.85	30	60	1	41	1.54
1bFFHDTN30L66WNOLNY	\$ 282.75	30	66	1	46	1.70
1bFFHDTN30L72WNOLNY	\$ 304.20	30	72	1	51	1.86
1bFFHDTN36L60WNOLNY	\$ 327.60	36	60	1	46	1.70
1bFFHDTN36L66WNOLNY	\$ 361.40	36	66	1	51	1.86
1bFFHDTN36L72WNOLNY	\$ 395.20	36	72	1	60	2.27

REQUIRED SPECIFICATIONS / SPÉCIFICATIONS REQUISES

- Laminate / Stratifié Included/Inclus

Free Standing Systems - Fixed Height Work Surfaces (Laminate) - 120 Degree - Panel Mounted

Systèmes autoportants - Surfaces de travail à hauteur fixe (stratifié) - 120 degrés - Montée sur panneau

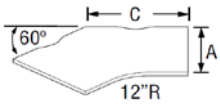

<i>GoCUID / CIUGdC</i>	<i>Price / Prix</i>	<i>D/P</i>	<i>W/L</i>	<i>H</i>	<i>WT</i>	<i>CU</i>
1bFFHDEN24L36WNOLNY	\$ 403.65	24	36	1	71	2.16
1bFFHDEN24L42WNOLNY	\$ 612.30	24	42	1		
1bFFHDEN24L48WNOLNY*	\$ 787.15	24	48	1		
1bFFHDEN24L54WNOLNY*	\$ 913.25	24	54	1		
1bFFHDEN24L60WNOLNY*	\$ 1,073.80	24	60	1		
1bFFHDEN30L36WNOLNY	\$ 431.60	30	36	1	76	2.31
1bFFHDEN30L42WNOLNY	\$ 663.00	30	42	1		
1bFFHDEN30L48WNOLNY*	\$ 830.70	30	48	1		
1bFFHDEN30L54WNOLNY*	\$ 1,008.80	30	54	1		
1bFFHDEN30L60WNOLNY*	\$ 1,179.10	30	60	1		

REQUIRED SPECIFICATIONS / SPÉCIFICATIONS REQUISES

- Laminate / Stratifié Included/Inclus

Grand & Toy

E60PQ-140003/045/PQ

CATEGORY 1B - PANEL HUNG WORK SURFACE - BOULEVARD

APPLICATION NOTES / INSTRUCTIONS D'APPLICATION

- Used in conjunction with Category 1A panel application
- All hardware and supporting brackets are to be specified separately
- Utiliser avec les panneaux de la catégorie 1A
- Tout le matériel et les supports doivent être spécifiés séparément

SAMPLE APPLICATION / EXEMPLE D'APPLICATION

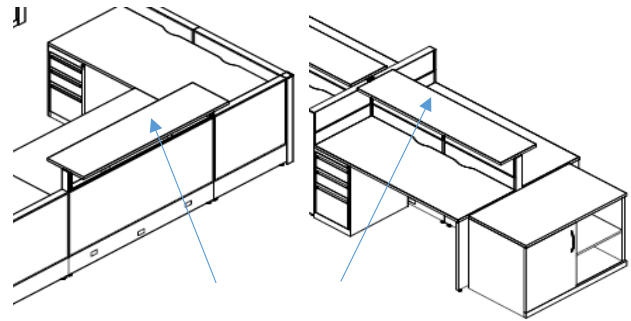

Free Standing Systems - Fixed Height Work Surfaces (Laminate) - Transaction Surface - Panel Mounted
 Systèmes autoportants - Surfaces de travail à hauteur fixe (stratifié) - Surface de transaction - Montée sur panneau

GoCUID / CIUGdC	Price / Prix	D/P	W/L	H	WT LB	CU
1bFFHTSN12L18XNOXNX	\$ 45.50	12	18	1	5	0.30
1bFFHTSN12L24XNOXNX	\$ 55.90	12	24	1	8	0.38
1bFFHTSN12L30XNOXNX	\$ 66.30	12	30	1	10	0.46
1bFFHTSN12L36XNOXNX	\$ 76.70	12	36	1	12	0.54
1bFFHTSN12L42XNOXNX	\$ 87.10	12	42	1	15	0.62
1bFFHTSN12L48XNOXNX	\$ 98.15	12	48	1	17	0.70
1bFFHTSN12L54XNOXNX	\$ 108.55	12	54	1	20	0.78
1bFFHTSN12L60XNOXNX	\$ 118.95	12	60	1	22	0.86
1bFFHTSN15L18XNOXNX	\$ 45.50	15	18	1	7	0.30
1bFFHTSN15L24XNOXNX	\$ 55.90	15	24	1	10	0.38
1bFFHTSN15L30XNOXNX	\$ 66.30	15	30	1	12	0.46
1bFFHTSN15L36XNOXNX	\$ 76.70	15	36	1	14	0.54
1bFFHTSN15L42XNOXNX	\$ 87.10	15	42	1	17	0.62
1bFFHTSN15L48XNOXNX	\$ 98.15	15	48	1	19	0.70
1bFFHTSN15L54XNOXNX	\$ 108.55	15	54	1	22	0.78
1bFFHTSN15L60XNOXNX	\$ 118.95	15	60	1	24	0.86
1bFFHTSN18L18XNOXNX	\$ 72.80	18	18	1	9	0.30
1bFFHTSN18L24XNOXNX	\$ 79.30	18	24	1	12	0.38
1bFFHTSN18L30XNOXNX	\$ 83.85	18	30	1	15	0.46
1bFFHTSN18L36XNOXNX	\$ 94.90	18	36	1	18	0.54
1bFFHTSN18L42XNOXNX	\$ 125.45	18	42	1	21	0.62
1bFFHTSN18L48XNOXNX	\$ 148.20	18	48	1	24	0.70
1bFFHTSN18L54XNOXNX	\$ 174.85	18	54	1	27	0.78
1bFFHTSN18L60XNOXNX	\$ 191.75	18	60	1	29	0.86

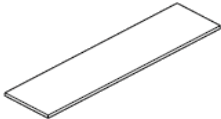

REQUIRED SPECIFICATIONS / SPÉCIFICATIONS REQUISES

- Laminate / Stratifié Included/Inclus

Grand & Toy

E60PQ-140003/045/PQ

CATEGORY 1B - TRANSACTION WORK SURFACE - BOULEVARD

APPLICATION NOTES / INSTRUCTIONS D'APPLICATION

- Modesty panel to be 8" or 14" off the ground, must specify with the exception of O-leg tables
- All hardware and supporting brackets included for connecting units
- Units are non-handed and may be used in left or right configurations
- **Items marked with a " * " are an extended lead time of 6 weeks**

- Panneau de modestie à 8 "ou 14" du sol, à spécifier, à l'exception des tables à pied en O
- Tout le matériel et les supports sont inclus pour le raccordement des modules
- Les modules sont réversibles et peuvent être utilisés dans des configurations gauche ou droite
- **Les articles marqués d'un " * " ont un délai de production de 6 semaines**

SAMPLE APPLICATION / EXEMPLE D'APPLICATION

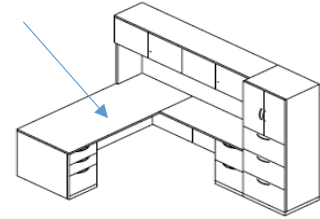

Free Standing Systems - Fixed Height Work Surfaces (Laminate) - Rectangular - 2 Full gables - Modesty (Laminate)

Systèmes autoportants - Surfaces de travail à hauteur fixe (stratifié) - Rectangulaire - 2 côtés pleine hauteur - Panneau de modestie (stratifié)

Rectangular Shell, 6" Recessed Modesty / Rectangulaire, panneau de modestie en retrait de 6 po

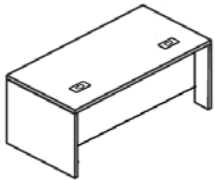

GoCUID / CIUGdC*	Price / Prix	D/P	W/L	H	WT LB	CU
1bFFHREG30L60WNOLNY	\$ 485.55	30	60	29	136	6.00
1bFFHREG30L66WNOLNY	\$ 514.15	30	66	29	45	7.00
1bFFHREG30L72WNOLNY	\$ 543.40	30	72	29	155	7.00
1bFFHREG30L78WNOLNY	\$ 572.00	30	78	29	175	9.00
1bFFHREG30L84WNOLNY	\$ 603.20	30	84	29	185	10.00

REQUIRED SPECIFICATIONS / SPÉCIFICATIONS REQUISES

- | | |
|--------------------------------------|-----------------|
| - Laminate / Stratifié | Included/Inclus |
| - Edge/Chant | Included/Inclus |
| - Modesty Height/Hauteur du modestie | Included/Inclus |
| - Grommets/Passe-fils | Included/Inclus |

* Please note the GoCUID used for this product is also applicable for other product combinations. The price shown is specific to the combination of components therein and may be shown below Ceiling Price.

* Veuillez noter que le GoCUID utilisé pour ce produit est également applicable à d'autres combinaisons de produits. Le prix indiqué est spécifique à la combinaison des composants et peut être inférieur au prix plafond

Rectangular Shell, Flush Modesty / Rectangulaire, panneau de modestie affleurant

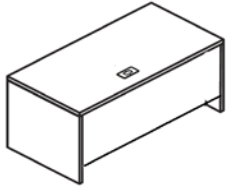

Up to 48"W
Jusqu'à 48 po L

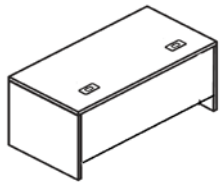

54"W and longer
54 po L et plus

GoCUID / CIUGdC*	Price / Prix	D/P	W/L	H	WT LB	CU
1bFFHREG24L30WNOLNY	\$ 304.20	24	30	29	77	3.00
1bFFHREG24L36WNOLNY	\$ 330.85	24	36	29	87	3.00
1bFFHREG24L42WNOLNY	\$ 358.15	24	42	29	94	3.00
1bFFHREG24L48WNOLNY	\$ 384.80	24	48	29	102	4.00
1bFFHREG24L54WNOLNY	\$ 410.80	24	54	29	109	4.00
1bFFHREG24L60WNOLNY	\$ 440.70	24	60	29	118	4.00
1bFFHREG24L66WNOLNY	\$ 467.35	24	66	29	127	6.00
1bFFHREG24L72WNOLNY	\$ 493.35	24	72	29	135	6.00
1bFFHREG24L78WNOLNY	\$ 520.65	24	78	29	151	7.00
1bFFHREG24L84WNOLNY	\$ 549.90	24	84	29	160	8.00
1bFFHREG30L30WNOLNY	\$ 337.35	30	30	29	90	3.00
1bFFHREG30L36WNOLNY	\$ 366.60	30	36	29	99	3.00
1bFFHREG30L42WNOLNY	\$ 395.20	30	42	29	109	4.00
1bFFHREG30L48WNOLNY	\$ 423.80	30	48	29	119	4.00
1bFFHREG30L54WNOLNY	\$ 453.05	30	54	29	127	6.00
1bFFHREG30L60WNOLNY	\$ 485.55	30	60	29	136	6.00
1bFFHREG30L66WNOLNY	\$ 514.15	30	66	29	145	7.00
1bFFHREG30L72WNOLNY	\$ 543.40	30	72	29	155	7.00
1bFFHREG30L78WNOLNY	\$ 572.00	30	78	29	175	9.00
1bFFHREG30L84WNOLNY	\$ 603.20	30	84	29	185	10.00

REQUIRED SPECIFICATIONS / SPÉCIFICATIONS REQUISES

- Laminate / Stratifié Included/Inclus
- Edge/Chant Included/Inclus
- Modesty Height/Hauteur du modestie Included/Inclus
- Grommets/Passe-fils Included/Inclus

* Please note the GoCUID used for this product is also applicable for other product combinations. The price shown is specific to the combination of components therein and may be shown below Ceiling Price.

* Veuillez noter que le GoCUID utilisé pour ce produit est également applicable à d'autres combinaisons de produits. Le prix indiqué est spécifique à la combinaison des composants et peut être inférieur au prix plafond

Rectangular Shell, Flush Modesty, Connecting Left or Right / Rectangulaire, panneau de modestie affleurant, réversible

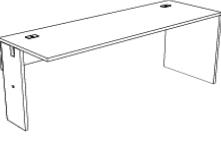
	GoCUID / CIUGdC*	Price / Prix	D/P	W/L	H	WT LB	CU
 <p>Up to 48"W Jusqu'à 48 po L</p>	1bFFHREG24L30WNOLNY	\$ 257.40	24	30	29	57	3.00
	1bFFHREG24L36WNOLNY	\$ 280.15	24	36	29	65	3.00
	1bFFHREG24L42WNOLNY	\$ 300.30	24	42	29	69	3.00
	1bFFHREG24L48WNOLNY	\$ 321.75	24	48	29	76	4.00
	1bFFHREG24L54WNOLNY	\$ 343.85	24	54	29	81	4.00
	1bFFHREG24L60WNOLNY	\$ 371.80	24	60	29	86	4.00
	1bFFHREG24L66WNOLNY	\$ 392.60	24	66	29	92	6.00
	1bFFHREG24L72WNOLNY	\$ 416.65	24	72	29	99	6.00
	1bFFHREG24L78WNOLNY	\$ 438.10	24	78	29	112	7.00
	1bFFHREG24L84WNOLNY	\$ 460.20	24	84	29	119	8.00
 <p>54"W and longer 54 po L et plus</p>	1bFFHREG30L30WNOLNY	\$ 287.95	30	30	29	77	3.00
	1bFFHREG30L36WNOLNY	\$ 312.65	30	36	29	83	3.00
	1bFFHREG30L42WNOLNY	\$ 336.05	30	42	29	87	4.00
	1bFFHREG30L48WNOLNY	\$ 360.10	30	48	29	92	4.00
	1bFFHREG30L54WNOLNY	\$ 384.80	30	54	29	98	6.00
	1bFFHREG30L60WNOLNY	\$ 414.70	30	60	29	105	6.00
	1bFFHREG30L66WNOLNY	\$ 439.40	30	66	29	111	7.00
	1bFFHREG30L72WNOLNY	\$ 464.75	30	72	29	119	7.00
	1bFFHREG30L78WNOLNY	\$ 489.45	30	78	29	136	9.00
	1bFFHREG30L84WNOLNY	\$ 513.50	30	84	29	144	10.00

* Units are non-handed and can be used as left or right. Right shown.

* Les modules sont réversibles et peuvent être utilisés à gauche ou à droite.

REQUIRED SPECIFICATIONS / SPÉCIFICATIONS REQUISES

- Laminate / Stratifié Included/Inclus
- Edge/Chant Included/Inclus
- Modesty Height/Hauteur du modestie Included/Inclus
- Grommets/Passe-fils Included/Inclus

* Please note the GoCUID used for this product is also applicable for other product combinations. The price shown is specific to the combination of components therein and may be shown below Ceiling Price.

* Veuillez noter que le GoCUID utilisé pour ce produit est également applicable à d'autres combinaisons de produits. Le prix indiqué est spécifique à la combinaison des composants et peut être inférieur au prix plafond

Rectangular Shell, Flush Modesty, Connecting Centre / Rectangulaire, panneau de modestie affleurant, raccord des 2 côtés



Up to 48"W
Jusqu'à 48 po L

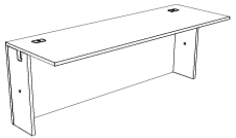

54"W and longer
54 po L et plus

GoCUID / CIUGdC*	Price / Prix	D/P	W/L	H	WT LB	CU
1bFFHREG24L30WNOLNY	\$ 230.75	24	30	29	62	3.00
1bFFHREG24L36WNOLNY	\$ 252.85	24	36	29	72	3.00
1bFFHREG24L42WNOLNY	\$ 273.65	24	42	29	78	3.00
1bFFHREG24L48WNOLNY	\$ 296.40	24	48	29	87	4.00
1bFFHREG24L54WNOLNY	\$ 317.20	24	54	29	95	4.00
1bFFHREG24L60WNOLNY	\$ 344.50	24	60	29	102	4.00
1bFFHREG24L66WNOLNY	\$ 366.60	24	66	29	111	6.00
1bFFHREG24L72WNOLNY	\$ 390.00	24	72	29	120	6.00
1bFFHREG24L78WNOLNY	\$ 411.45	24	78	29	135	7.00
1bFFHREG24L84WNOLNY	\$ 432.90	24	84	29	144	8.00
1bFFHREG30L30WNOLNY	\$ 267.15	30	30	29	75	3.00
1bFFHREG30L36WNOLNY	\$ 289.25	30	36	29	84	3.00
1bFFHREG30L42WNOLNY	\$ 313.95	30	42	29	94	4.00
1bFFHREG30L48WNOLNY	\$ 339.30	30	48	29	103	4.00
1bFFHREG30L54WNOLNY	\$ 362.70	30	54	29	116	6.00
1bFFHREG30L60WNOLNY	\$ 392.60	30	60	29	121	6.00
1bFFHREG30L66WNOLNY	\$ 417.30	30	66	29	130	7.00
1bFFHREG30L72WNOLNY	\$ 442.65	30	72	29	140	7.00
1bFFHREG30L78WNOLNY	\$ 467.35	30	78	29	160	9.00
1bFFHREG30L84WNOLNY	\$ 491.40	30	84	29	169	10.00

REQUIRED SPECIFICATIONS / SPÉCIFICATIONS REQUISES

- Laminate / Stratifié Included/Inclus
- Edge/Chant Included/Inclus
- Modesty Height/Hauteur du modestie Included/Inclus
- Grommets/Passe-fils Included/Inclus

* Please note the GoCUID used for this product is also applicable for other product combinations. The price shown is specific to the combination of components therein and may be shown below Ceiling Price.

* Veuillez noter que le GoCUID utilisé pour ce produit est également applicable à d'autres combinaisons de produits. Le prix indiqué est spécifique à la combinaison des composants et peut être inférieur au prix plafond

Rectangular Shell, Flush Modesty, O-Leg / Rectangulaire, panneau de modestie affleurant, patte en O

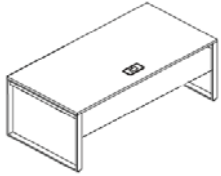

Up to 48"W
Jusqu'à 48 po L

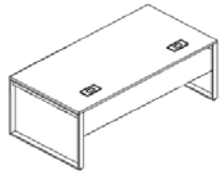

54"W and longer
54 po L et plus

GoCUID / CIUGdC*	Price / Prix	D/P	W/L	H	WT LB	CU
1bFFHREG24L30WNOLNY	\$ 626.60	24	30	29	112	6.00
1bFFHREG24L36WNOLNY	\$ 638.30	24	36	29	129	6.00
1bFFHREG24L42WNOLNY	\$ 675.35	24	42	29	137	6.00
1bFFHREG24L48WNOLNY	\$ 709.15	24	48	29	143	7.00
1bFFHREG24L54WNOLNY	\$ 784.55	24	54	29	159	7.00
1bFFHREG24L60WNOLNY	\$ 817.05	24	60	29	176	7.00
1bFFHREG24L66WNOLNY	\$ 835.90	24	66	29	192	8.00
1bFFHREG24L72WNOLNY	\$ 856.70	24	72	29	209	8.00
1bFFHREG24L78WNOLNY	\$ 882.70	24	78	29	225	8.00
1bFFHREG24L84WNOLNY	\$ 911.95	24	84	29	242	9.00
1bFFHREG30L30WNOLNY	\$ 664.95	30	30	29	141	9.00
1bFFHREG30L36WNOLNY	\$ 683.15	30	36	29	147	9.00
1bFFHREG30L42WNOLNY	\$ 739.70	30	42	29	154	9.00
1bFFHREG30L48WNOLNY	\$ 756.60	30	48	29	175	9.00
1bFFHREG30L54WNOLNY	\$ 819.00	30	54	29	195	10.00
1bFFHREG30L60WNOLNY	\$ 847.60	30	60	29	216	10.00
1bFFHREG30L66WNOLNY	\$ 867.10	30	66	29	235	11.00
1bFFHREG30L72WNOLNY	\$ 890.50	30	72	29	256	11.00
1bFFHREG30L78WNOLNY	\$ 915.20	30	78	29	276	11.00
1bFFHREG30L84WNOLNY	\$ 953.55	30	84	29	297	12.00

- May be used with Bridges storage units / Doit être utilisé avec les modules de rangement Bridges

REQUIRED SPECIFICATIONS / SPÉCIFICATIONS REQUISES

- Laminate / Stratifié Included/Inclus
- Edge/Chant Included/Inclus
- Modesty Height/Hauteur du modestie Included/Inclus
- Grommets/Passe-fils Included/Inclus
- Metal leg/Patte en métal Included/Inclus

* Please note the GoCUID used for this product is also applicable for other product combinations. The price shown is specific to the combination of components therein and may be shown below Ceiling Price.

* Veuillez noter que le GoCUID utilisé pour ce produit est également applicable à d'autres combinaisons de produits. Le prix indiqué est spécifique à la combinaison des composants et peut être inférieur au prix plafond

Free Standing Systems - Fixed Height Work Surfaces (Laminate) - Transitional - 2 Full gables - Modesty (Laminate)

Systèmes autoportants - Surfaces de travail à hauteur fixe (stratifié) - Transitionnelle - 2 côtés pleine hauteur - Panneaux de modestie (stratifié)

Transitional Shell, Flush Modesty / Transitionnelle, panneau de modestie affleurant

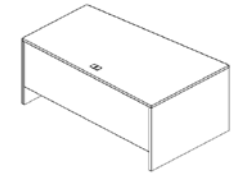

Up to 48"W
Jusqu'à 48 po L

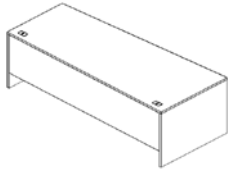

54"W and longer
54 po L et plus

GoCUID / CIUGdC*	Price / Prix	D/P	W/L	H	WT LB	CU
1bFFHTNGTRL30WNOLNY*	\$ 324.35	24-30	30	29	82	3.00
1bFFHTNGTRL36WNOLNY*	\$ 353.60	24-30	36	29	91	3.00
1bFFHTNGTRL42WNOLNY*	\$ 382.20	24-30	42	29	101	4.00
1bFFHTNGTRL48WNOLNY*	\$ 410.80	24-30	48	29	111	4.00
1bFFHTNGTRL54WNOLNY*	\$ 440.05	24-30	54	29	119	6.00
1bFFHTNGTRL60WNOLNY*	\$ 472.55	24-31	60	29	128	6.00
1bFFHTNGTRL66WNOLNY*	\$ 501.15	24-32	66	29	137	7.00
1bFFHTNGTRL72WNOLNY*	\$ 530.40	24-33	72	29	147	7.00
1bFFHTNGTRL78WNOLNY*	\$ 559.00	24-34	78	29	167	9.00
1bFFHTNGTRL84WNOLNY*	\$ 590.20	24-35	84	29	177	10.00

* GoCUID is generic to size and shape but not specific to orientation. Please specify accordingly

* GoCUID est générique pour la taille et la forme mais pas spécifique pour l'orientation. Veuillez spécifier en conséquence

REQUIRED SPECIFICATIONS / SPÉCIFICATIONS REQUISES

- Laminate / Stratifié Included/Inclus
- Edge/Chant Included/Inclus
- Modesty Height/Hauteur du modestie Included/Inclus
- Grommets/Passe-fils Included/Inclus

* Please note the GoCUID used for this product is also applicable for other product combinations. The price shown is specific to the combination of components therein and may be shown below Ceiling Price.

* Veuillez noter que le GoCUID utilisé pour ce produit est également applicable à d'autres combinaisons de produits. Le prix indiqué est spécifique à la combinaison des composants et peut être inférieur au prix plafond

Transitional Shell, Flush Modesty, O-Leg / Transitionnelle, panneau de modestie affleurant, patte en O

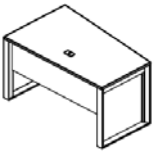

Up to 48"W
Jusqu'à 48 po L

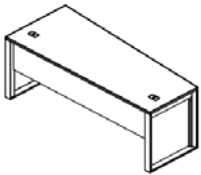

54"W and longer
54 po L et plus

GoCUID / CIUGdC*	Price / Prix	D/P	W/L	H	WT LB	CU
1bFFHTNGTRL30WNOLNY*	\$ 754.65	24-30	30	29	133	9.00
1bFFHTNGTRL36WNOLNY*	\$ 754.65	24-30	36	29	139	9.00
1bFFHTNGTRL42WNOLNY*	\$ 761.80	24-30	42	29	146	9.00
1bFFHTNGTRL48WNOLNY*	\$ 769.60	24-30	48	29	168	9.00
1bFFHTNGTRL54WNOLNY*	\$ 844.35	24-30	54	29	187	10.00
1bFFHTNGTRL60WNOLNY*	\$ 880.10	24-31	60	29	208	10.00
1bFFHTNGTRL66WNOLNY*	\$ 914.55	24-32	66	29	227	11.00
1bFFHTNGTRL72WNOLNY*	\$ 950.95	24-33	72	29	248	11.00
1bFFHTNGTRL78WNOLNY*	\$ 979.55	24-34	78	29	268	11.00
1bFFHTNGTRL84WNOLNY*	\$ 1,025.70	24-35	84	29	289	12.00

* GoCUID is generic to size and shape but not specific to orientation. Please specify accordingly

* GoCUID est générique pour la taille et la forme mais pas spécifique pour l'orientation. Veuillez spécifier en conséquence

REQUIRED SPECIFICATIONS / SPÉCIFICATIONS REQUISES

- Laminate / Stratifié	Included/Inclus
- Edge/Chant	Included/Inclus
- Modesty Height/Hauteur du modestie	Included/Inclus
- Grommets/Passe-fils	Included/Inclus
- Metal leg/Patte en métal	Included/Inclus

* Please note the GoCUID used for this product is also applicable for other product combinations. The price shown is specific to the combination of components therein and may be shown below Ceiling Price.

* Veuillez noter que le GoCUID utilisé pour ce produit est également applicable à d'autres combinaisons de produits. Le prix indiqué est spécifique à la combinaison des composants et peut être inférieur au prix plafond

Free Standing Systems - Fixed Height Work Surfaces (Laminate) - D Top - 2 Full gables - Modesty (Laminate)

Systèmes autoportants - Surfaces de travail à hauteur fixe (stratifié) - en D - 2 côtés pleine hauteur - Panneaux de modestie (stratifié)

D Top Shell, Inset Modesty / En D, panneau de modestie inséré

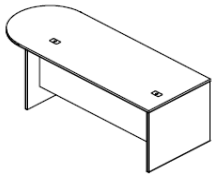

GoCUID / CIUGdC*	Price / Prix	D/P	W/L	H	WT LB	CU
1bFFHDTG24L60WNOLNY*	\$ 815.10	24	60	29		
1bFFHDTG24L66WNOLNY*	\$ 827.45	24	66	29		
1bFFHDTG24L72WNOLNY*	\$ 913.25	24	72	29		
1bFFHDTG30L60WNOLNY*	\$ 861.25	30	60	29		
1bFFHDTG30L66WNOLNY*	\$ 878.15	30	66	29		
1bFFHDTG30L72WNOLNY*	\$ 974.35	30	72	29		
1bFFHDTG36L60WNOLNY*	\$ 952.90	36	60	29		
1bFFHDTG36L66WNOLNY*	\$ 986.70	36	66	29		
1bFFHDTG36L72WNOLNY*	\$ 1,095.25	36	72	29		

* GoCUID is generic to size and shape but not specific to orientation. Please specify accordingly

* GoCUID est générique pour la taille et la forme mais pas spécifique pour l'orientation. Veuillez spécifier en conséquence

REQUIRED SPECIFICATIONS / SPÉCIFICATIONS REQUISES

- Work surface Laminate / Stratifié-Dessus Included/Inclus
- Gable Laminate / Stratifié-Côtés Included/Inclus
- Edge/Chant Included/Inclus
- Modesty Height/Hauteur du modestie Included/Inclus
- Grommet Finish/Fini du passe-fils Included/Inclus

* Please note the GoCUID used for this product is also applicable for other product combinations. The price shown is specific to the combination of components therein and may be shown below Ceiling Price.

* Veuillez noter que le GoCUID utilisé pour ce produit est également applicable à d'autres combinaisons de produits. Le prix indiqué est spécifique à la combinaison des composants et peut être inférieur au prix plafond

D Top Shell, Inset Modesty, O-Leg / En D, panneau de modestie inséré, patte en O

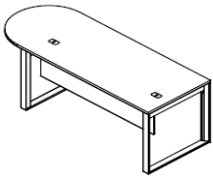

GoCUID / CIUGdC*	Price / Prix	D/P	W/L	H	WT LB	CU
1bFFHDTG24L60WNOLNY*	\$ 764.40	24	60	29		
1bFFHDTG24L66WNOLNY*	\$ 776.75	24	66	29		
1bFFHDTG24L72WNOLNY*	\$ 862.55	24	72	29		
1bFFHDTG30L60WNOLNY*	\$ 810.55	30	60	29		
1bFFHDTG30L66WNOLNY*	\$ 827.45	30	66	29		
1bFFHDTG30L72WNOLNY*	\$ 923.65	30	72	29		
1bFFHDTG36L60WNOLNY*	\$ 902.20	36	60	29		
1bFFHDTG36L66WNOLNY*	\$ 936.00	36	66	29		
1bFFHDTG36L72WNOLNY*	\$ 1,044.55	36	72	29		

* GoCUID is generic to size and shape but not specific to orientation. Please specify accordingly

* GoCUID est générique pour la taille et la forme mais pas spécifique pour l'orientation. Veuillez spécifier en conséquence

REQUIRED SPECIFICATIONS / SPÉCIFICATIONS REQUISES

- Laminate / Stratifié	Included/Inclus
- Edge/Chant	Included/Inclus
- Modesty Height/Hauteur du modestie	Included/Inclus
- Grommets/Passe-fils	Included/Inclus
- Metal leg/Patte en métal	Included/Inclus

* Please note the GoCUID used for this product is also applicable for other product combinations. The price shown is specific to the combination of components therein and may be shown below Ceiling Price.

* Veuillez noter que le GoCUID utilisé pour ce produit est également applicable à d'autres combinaisons de produits. Le prix indiqué est spécifique à la combinaison des composants et peut être inférieur au prix plafond

Grand & Toy

E60PQ-140003/045/PQ

CATEGORY 1B - TWO FULL GABLE WORK SURFACE - LICENCE

Grand & Toy

E60PQ-140003/045/PQ

CATEGORY 1B - POST LEG WORK SURFACE - LICENCE

APPLICATION NOTES / INSTRUCTIONS D'APPLICATION

- When used against a panel or wall a modesty is not required
- When used perpendicular to a panel, wall, or open plan a modesty must be specified
- All hardware and supporting brackets included
- **Items marked with a " * " are an extended lead time of 6 weeks**
- Lorsqu'utilisé contre un panneau ou un mur, le panneau de modestie n'est pas requis
- Lorsqu'utilisé perpendiculaire à un panneau ou à un mur, un panneau de modestie doit être spécifié
- Tout le matériel et les supports sont inclus
- **Les articles marqués d'un " * " ont un délai de production de 6 semaines**

SAMPLE APPLICATION / EXEMPLE D'APPLICATION

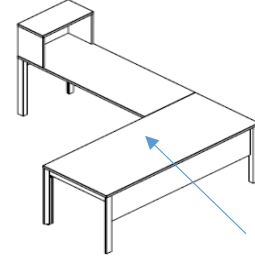

Free Standing Systems - Fixed Height Work Surfaces (Laminate) - Rectangular - Post Legs - Modesty (Laminate)

Systèmes autoportants - Surfaces de travail à hauteur fixe (stratifié) - Rectangulaire - Pattes - Panneau de modestie (stratifié)

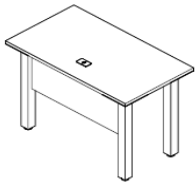

Up to 48"W
Jusqu'à 48 po L

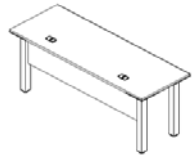

54"W and longer
54 po L et plus

GoCUID / CIUGdC	Price / Prix	D/P	W/L	H	WT LB	CU
1bFFHREL24L30WNOLNY	\$ 575.90	24	30	29	65	1.54
1bFFHREL24L36WNOLNY	\$ 587.60	24	36	29	71	1.71
1bFFHREL24L42WNOLNY	\$ 620.75	24	42	29	77	1.87
1bFFHREL24L48WNOLNY	\$ 652.60	24	48	29	81	2.03
1bFFHREL24L54WNOLNY	\$ 723.45	24	54	29	91	2.44
1bFFHREL24L60WNOLNY	\$ 771.55	24	60	29	98	2.60
1bFFHREL24L66WNOLNY	\$ 791.05	24	66	29	105	2.77
1bFFHREL24L72WNOLNY	\$ 814.45	24	72	29	111	2.97
1bFFHREL24L78WNOLNY	\$ 846.95	24	78	29	118	3.20
1bFFHREL24L84WNOLNY	\$ 885.95	24	84	29	126	3.37
1bFFHREL30L30WNOLNY	\$ 592.15	30	30	29	70	1.70
1bFFHREL30L36WNOLNY	\$ 610.35	30	36	29	76	1.93
1bFFHREL30L42WNOLNY	\$ 663.00	30	42	29	83	2.10
1bFFHREL30L48WNOLNY	\$ 677.95	30	48	29	89	2.30
1bFFHREL30L54WNOLNY	\$ 735.80	30	54	29	100	2.68
1bFFHREL30L60WNOLNY	\$ 780.00	30	60	29	108	2.90
1bFFHREL30L66WNOLNY	\$ 800.15	30	66	29	116	3.12
1bFFHREL30L72WNOLNY	\$ 826.15	30	72	29	123	3.34
1bFFHREL30L78WNOLNY	\$ 857.35	30	78	29	131	3.60
1bFFHREL30L84WNOLNY	\$ 905.45	30	84	29	140	0.33

REQUIRED SPECIFICATIONS / SPÉCIFICATIONS REQUISES

- Laminate / Stratifié Included/Inclus
- Modesty Height/Hauteur du modestie Included/Inclus
- Edge/Chant Included/Inclus
- Round Leg/Patte ronde Included/Inclus
- Grommets/Passe-fils Included/Inclus

ADDITIONAL OPTIONS / OPTIONS ADDITIONELLES

- Chrome round leg/Pied rond Chrome \$ 244.40
- Tapered Leg/Patte fuselée \$ 10.40
- Tapered Leg Chrome/Patte fuselée Chrome \$ 239.20
- Square Leg/Patte carrée \$ 83.20
- Square Leg Chrome/Patte carrée Chrome \$ 301.60

* upcharges are per complete table

* les frais supplémentaires sont par table complète

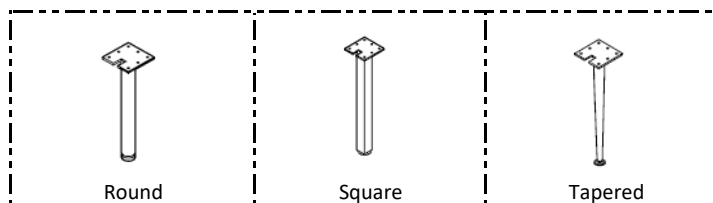

Grand & Toy

E60PQ-140003/045/PQ

CATEGORY 1B - POST LEG WORK SURFACE - LICENCE

Free Standing Systems - Fixed Height Work Surfaces (Laminate) - Transitional - Post Legs - Modesty (Laminate)

Systèmes autoportants - Surfaces de travail à hauteur fixe (stratifié) - Transitionnelle - Pattes - Panneau de modestie (stratifié)

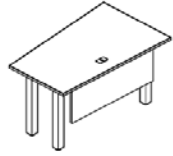

30-48"

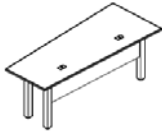

54-84"

GoCUID / CIUGdC	Price / Prix	D/P	W/L	H	WT LB	CU
1bFFHTNLTRL30WNOLNY*	\$ 692.90	24-30	30	29	68	1.70
1bFFHTNLTRL36WNOLNY*	\$ 692.90	24-30	36	29	74	1.93
1bFFHTNLTRL42WNOLNY*	\$ 696.15	24-30	42	29	81	2.10
1bFFHTNLTRL48WNOLNY*	\$ 702.00	24-30	48	29	87	2.30
1bFFHTNLTRL54WNOLNY*	\$ 772.20	24-30	54	29	98	2.68
1bFFHTNLTRL60WNOLNY*	\$ 823.55	24-30	60	29	106	2.90
1bFFHTNLTRL66WNOLNY*	\$ 858.65	24-30	66	29	114	3.12
1bFFHTNLTRL72WNOLNY*	\$ 897.65	24-30	72	29	121	3.34
1bFFHTNLTRL78WNOLNY*	\$ 932.75	24-30	78	29	129	3.60
1bFFHTNLTRL84WNOLNY*	\$ 988.65	24-30	84	29	138	0.33

* GoCUID is generic to size and shape but not specific to orientation. Please specify accordingly

* GoCUID est générique pour la taille et la forme mais pas spécifique pour l'orientation. Veuillez spécifier en conséquence

Free Standing Systems - Fixed Height Work Surfaces (Laminate) - D top - Post Legs - Modesty (Laminate)

Systèmes autoportants - Surfaces de travail à hauteur fixe (stratifié) - En D - Pattes - Panneau de modestie (stratifié)

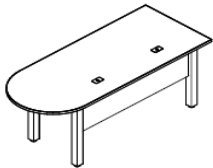

GoCUID / CIUGdC	Price / Prix	D/P	W/L	H	WT LB	CU
1bFFHDTL24L60WNOLNY*	\$ 813.15	24	60	29	98	2.60
1bFFHDTL24L66WNOLNY*	\$ 835.90	24	66	29	105	2.77
1bFFHDTL24L72WNOLNY*	\$ 858.65	24	72	29	111	2.97
1bFFHDTL30L60WNOLNY*	\$ 837.20	30	60	29	108	2.90
1bFFHDTL30L66WNOLNY*	\$ 864.50	30	66	29	116	3.12
1bFFHDTL30L72WNOLNY*	\$ 897.65	30	72	29	123	3.34
1bFFHDTL36L60WNOLNY*	\$ 898.95	36	60	29	118	
1bFFHDTL36L66WNOLNY*	\$ 943.15	36	66	29	126	
1bFFHDTL36L72WNOLNY*	\$ 988.65	36	72	29	133	

REQUIRED SPECIFICATIONS / SPÉCIFICATIONS REQUISES

- Laminate / Stratifié	Included/Inclus
- Modesty Height/Hauteur du modestie	Included/Inclus
- Edge/Chant	Included/Inclus
- Round Leg/Patte ronde	Included/Inclus
- Grommets/Passe-fils	Included/Inclus

ADDITIONAL OPTIONS / OPTIONS ADDITIONELLES

- Chrome round leg/Pied rond Chrome	\$ 244.40
- Tapered Leg/Patte fuselée	\$ 10.40
- Tapered Leg Chrome/Patte fuselée Chrome	\$ 239.20
- Square Leg/Patte carrée	\$ 83.20
- Square Leg Chrome/Patte carrée Chrome	\$ 301.60

* upcharges are per complete table

* les frais supplémentaires sont par table complète

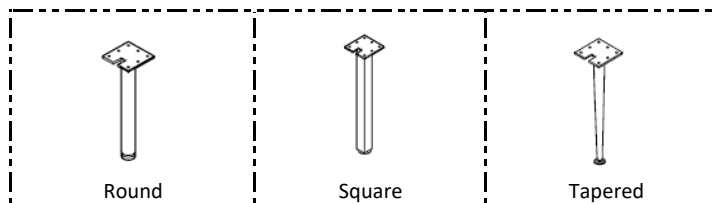

Grand & Toy

E60PQ-140003/045/PQ

CATEGORY 1B - POST LEG WORK SURFACE - LICENCE

APPLICATION NOTES / INSTRUCTIONS D'APPLICATION

- When used against a panel or wall a modesty is not required
- When used perpendicular to a panel, wall, or open plan a modesty must be specified
- All hardware and supporting brackets included
- Surfaces with metal modesty 66" and above have 3 leg supports
- **Items marked with a " * " are an extended lead time of 6 weeks**
- Lorsqu'utilisé contre un panneau ou un mur, un panneau de modestie n'est pas requis
- Lorsqu'utilisé perpendiculaire à un panneau ou à un mur, un panneau de modestie doit être spécifié
- Tout le matériel et les supports sont inclus
- Les surfaces avec un panneau de modestie métallique de 66 "et plus ont 3 supports de pattes
- **Les articles marqués d'un " * " ont un délai de production de 6 semaines**

Free Standing Systems - Fixed Height Work Surfaces (Laminate) - Rectangular - C Legs - Modesty (Metal)

Systèmes autoportants - Surfaces de travail à hauteur fixe (stratifié) - Rectangulaire - Pieds en C - Panneau de modestie (métal)

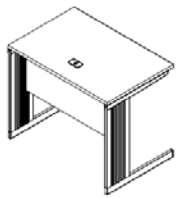

Up to 48"W
Jusqu'à 48 po L

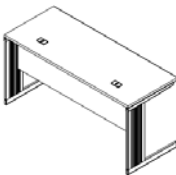

54"W and longer
54 po L et plus

GoCUID / CIUGdC	Price / Prix	D/P	W/L	H	WT LB	CU
1bFFHREC24L30WNOANY	\$ 431.60	24	30	29	41	1.87
1bFFHREC24L36WNOANY	\$ 449.15	24	36	29	45	2.08
1bFFHREC24L42WNOANY	\$ 482.95	24	42	29	50	2.28
1bFFHREC24L48WNOANY	\$ 514.15	24	48	29	54	2.47
1bFFHREC24L54WNOANY	\$ 559.65	24	54	29	58	2.72
1bFFHREC24L60WNOANY	\$ 588.25	24	60	29	63	2.90
1bFFHREC24L66WNOANY	\$ 779.35	24	66	29	76	3.47
1bFFHREC24L72WNOANY	\$ 794.95	24	72	29	80	3.68
1bFFHREC24L78WNOANY	\$ 813.15	24	78	29	85	3.92
1bFFHREC24L84WNOANY	\$ 834.60	24	84	29	90	4.14
<hr/>						
1bFFHREC30L30WNOANY	\$ 447.85	30	30	29	46	2.03
1bFFHREC30L36WNOANY	\$ 471.90	30	36	29	50	2.30
1bFFHREC30L42WNOANY	\$ 525.20	30	42	29	56	2.51
1bFFHREC30L48WNOANY	\$ 539.50	30	48	29	62	2.74
1bFFHREC30L54WNOANY	\$ 572.00	30	54	29	67	2.96
1bFFHREC30L60WNOANY	\$ 596.70	30	60	29	73	3.20
1bFFHREC30L66WNOANY	\$ 788.45	30	66	29	87	3.82
1bFFHREC30L72WNOANY	\$ 806.65	30	72	29	92	4.05
1bFFHREC30L78WNOANY	\$ 823.55	30	78	29	98	4.32
1bFFHREC30L84WNOANY	\$ 854.10	30	84	29	104	4.58

REQUIRED SPECIFICATIONS / SPÉCIFICATIONS REQUISES

- | | |
|--------------------------------------|-----------------|
| - Laminate / Stratifié | Included/Inclus |
| - Edge/Chant | Included/Inclus |
| - Modesty Height/Hauteur du modestie | Included/Inclus |
| - Grommets/Passe-fils | Included/Inclus |
| - Metal leg/Pied en métal | Included/Inclus |
| - Metal modesty/Modestie en métal | Included/Inclus |

Free Standing Systems - Fixed Height Work Surfaces (Laminate) - Transitional - C Legs - Modesty (Metal)

Systèmes autoportants - Surfaces de travail à hauteur fixe (stratifié) - Transitionnelle - Pieds en C - Panneau de modestie (métal)

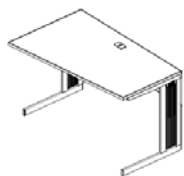

Up to 48"W
Jusqu'à 48 po L

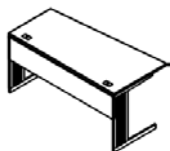

54"W and longer
54 po L et plus

GoCUID / CIUGdC	Price / Prix	D/P	W/L	H	WT LB	CU
1bFFHTNCTRL30WNOANY*	\$ 548.60	24-30	30	29	52	2.31
1bFFHTNCTRL36WNOANY*	\$ 554.45	24-30	36	29	58	2.40
1bFFHTNCTRL42WNOANY*	\$ 558.35	24-30	42	29	64	2.46
1bFFHTNCTRL48WNOANY*	\$ 563.55	24-30	48	29	71	2.64
1bFFHTNCTRL54WNOANY*	\$ 608.40	24-30	54	29	80	2.98
1bFFHTNCTRL60WNOANY*	\$ 640.25	24-30	60	29	89	3.16
1bFFHTNCTRL66WNOANY*	\$ 846.95	24-30	66	29	97	3.39
1bFFHTNCTRL72WNOANY*	\$ 878.15	24-30	72	29	104	3.62
1bFFHTNCTRL78WNOANY*	\$ 898.95	24-30	78	29	112	3.75
1bFFHTNCTRL84WNOANY*	\$ 937.30	24-30	84	29	120	3.91

* GoCUID is generic to size and shape but not specific to orientation. Please specify accordingly

* GoCUID est générique pour la taille et la forme mais pas spécifique pour l'orientation. Veuillez spécifier en conséquence

Free Standing Systems - Fixed Height Work Surfaces (Laminate) - D Top - C Legs - Modesty (Metal)

Systèmes autoportants - Surfaces de travail à hauteur fixe (stratifié) - En D - Pieds en C - Panneau de modestie (métal)

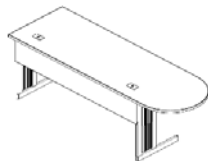

GoCUID / CIUGdC	Price / Prix	D/P	W/L	H	WT LB*	CU*
1bFFHDTC24L60WNOANY*	\$ 629.20	24	60	29	63	2.90
1bFFHDTC24L66WNOANY*	\$ 641.55	24	66	29	76	3.47
1bFFHDTC24L72WNOANY*	\$ 652.60	24	72	29	80	3.68
1bFFHDTC30L60WNOANY*	\$ 653.25	30	60	29	73	3.20
1bFFHDTC30L66WNOANY*	\$ 670.15	30	66	29	87	3.82
1bFFHDTC30L72WNOANY*	\$ 691.60	30	72	29	92	4.05

* Approximate/Approximatif

REQUIRED SPECIFICATIONS / SPÉCIFICATIONS REQUISES

- Laminate / Stratifié	Included/Inclus
- Edge/Chant	Included/Inclus
- Modesty Height/Hauteur du modestie	Included/Inclus
- Grommets/Passe-fils	Included/Inclus
- Metal leg/Pied en métal	Included/Inclus
- Metal modesty/Modestie en métal	

Grand & Toy

E60PQ-140003/045/PQ

CATEGORY 1B - C LEG WORK SURFACE - LICENCE

APPLICATION NOTES / INSTRUCTIONS D'APPLICATION

- When used against a panel or wall a modesty is not required
- When used perpendicular to a panel, wall, or open plan a modesty must be specified
- All hardware and supporting brackets included
- For use on Licence 1H Partial Height storage unit only
- **Items marked with a " * " are an extended lead time of 6 weeks**

- Lorsqu'utilisé contre un panneau ou un mur, un panneau de modestie n'est pas requis
- Lorsqu'utilisé perpendiculaire à un panneau ou à un mur, un panneau de modestie doit être spécifié
- Tout le matériel et les supports sont inclus
- À utiliser avec le module de rangement Licence 1H à hauteur partielle uniquement
- **Les articles marqués d'un " * " ont un délai de production de 6 semaines**

SAMPLE APPLICATION / EXEMPLE D'APPLICATION

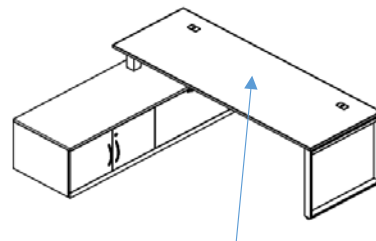

Free Standing Systems - Fixed Height Work Surfaces (Laminate) - Rectangular - 1 Work Surface Support, 1 Full Gable - Modesty (Laminate)
 Systèmes autoportants - Surfaces de travail à hauteur fixe (stratifié) - Rectangulaire - Un côté pleine hauteur - Panneau de modestie (stratifié)

GoCUID / CIUGdC Price / Prix D/P W/L H WT LB CU

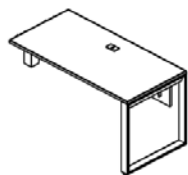

Up to 48"W
Jusqu'à 48 po L

1bFFHREW24L30WNOLNY	\$ 551.85	24	30	29	48	2.05
1bFFHREW24L36WNOLNY	\$ 563.55	24	36	29	52	2.18
1bFFHREW24L42WNOLNY	\$ 596.70	24	42	29	58	2.34
1bFFHREW24L48WNOLNY	\$ 628.55	24	48	29	63	2.51
1bFFHREW24L54WNOLNY	\$ 699.40	24	54	29	72	2.91
1bFFHREW24L60WNOLNY	\$ 747.50	24	60	29	80	3.07
1bFFHREW24L66WNOLNY	\$ 767.00	24	66	29	86	3.25
1bFFHREW24L72WNOLNY	\$ 790.40	24	72	29	93	3.44
1bFFHREW24L78WNOLNY	\$ 822.90	24	78	29	99	3.67
1bFFHREW24L84WNOLNY	\$ 861.90	24	84	29	106	3.83

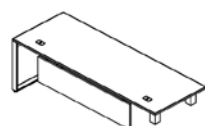

54"W and longer
54 po L et plus

1bFFHREW30L30WNOLNY	\$ 579.15	30	30	29	56	2.46
1bFFHREW30L36WNOLNY	\$ 597.35	30	36	29	60	2.65
1bFFHREW30L42WNOLNY	\$ 650.00	30	42	29	67	2.82
1bFFHREW30L48WNOLNY	\$ 664.95	30	48	29	74	3.03
1bFFHREW30L54WNOLNY	\$ 817.05	30	54	29	84	3.40
1bFFHREW30L60WNOLNY	\$ 767.00	30	60	29	93	3.62
1bFFHREW30L66WNOLNY	\$ 787.15	30	66	29	100	3.85
1bFFHREW30L72WNOLNY	\$ 813.15	30	72	29	108	4.06
1bFFHREW30L78WNOLNY	\$ 844.35	30	78	29	115	4.32
1bFFHREW30L84WNOLNY	\$ 892.45	30	84	29	123	4.52

REQUIRED SPECIFICATIONS / SPÉCIFICATIONS REQUISES

- | | |
|--------------------------------------|-----------------|
| - Laminate / Stratifié | Included/Inclus |
| - Edge/Chant | Included/Inclus |
| - Modesty Height/Hauteur du modestie | Included/Inclus |
| - Grommets/Passe-fils | Included/Inclus |
| - Metal leg/Patte en métal | Included/Inclus |

Free Standing Systems - Fixed Height Work Surfaces (Laminate) - Transitional - 1 Work Surface Support, 1 Full Gable - Modesty (Laminate)
 Systèmes autoportants - Surfaces de travail à hauteur fixe (stratifié) - Transitionnelle - Un côté pleine hauteur - Panneau de modestie (stratifié)



Up to 48"W
 Jusqu'à 48 po L

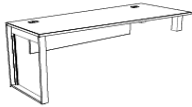

54"W and longer
 54 po L et plus

GoCUID / CIUGdC	Price / Prix	D/P	W/L	H	WT LB	CU
1bFFHTNWTRL30WNOLNY*	\$ 643.50	24-30	30	29	54	2.46
1bFFHTNWTRL36WNOLNY*	\$ 643.50	24-30	36	29	58	2.65
1bFFHTNWTRL42WNOLNY*	\$ 646.75	24-30	42	29	65	2.82
1bFFHTNWTRL48WNOLNY*	\$ 652.60	24-30	48	29	72	3.03
1bFFHTNWTRL54WNOLNY*	\$ 722.80	24-30	54	29	82	3.40
1bFFHTNWTRL60WNOLNY*	\$ 774.15	24-30	60	29	91	3.62
1bFFHTNWTRL66WNOLNY*	\$ 809.25	24-30	66	29	98	3.85
1bFFHTNWTRL72WNOLNY*	\$ 848.25	24-30	72	29	106	4.06
1bFFHTNWTRL78WNOLNY*	\$ 883.35	24-30	78	29	113	4.32
1bFFHTNWTRL84WNOLNY*	\$ 939.25	24-30	84	29	121	4.52

* Gable leg is always on the shortest depth side.

* La patte courte est toujours du côté le moins profond

Free Standing Systems - Fixed Height Work Surfaces (Laminate) - D Top - 1 Work Surface Support, 1 Full Gable - Modesty (Laminate)
 Systèmes autoportants - Surfaces de travail à hauteur fixe (stratifié) - En D - Un côté pleine hauteur - Panneau de modestie (stratifié)



GoCUID / CIUGdC	Price / Prix	D/P	W/L	H	WT LB	CU
1bFFHDTW24L60WNOLNY*	\$ 737.10	24	60	29	54	2.46
1bFFHDTW24L66WNOLNY*	\$ 749.45	24	66	29	58	2.65
1bFFHDTW24L72WNOLNY*	\$ 835.25	24	72	29	65	2.82
1bFFHDTW30L60WNOLNY*	\$ 772.20	30	60	29	82	3.40
1bFFHDTW30L66WNOLNY*	\$ 789.10	30	66	29	91	3.62
1bFFHDTW30L72WNOLNY*	\$ 885.30	30	72	29	98	3.85
1bFFHDTW36L60WNOLNY*	\$ 848.90	36	60	29	113	4.12
1bFFHDTW36L66WNOLNY*	\$ 882.70	36	66	29	113	4.45
1bFFHDTW36L72WNOLNY*	\$ 991.25	36	72	29	121	4.76

REQUIRED SPECIFICATIONS / SPÉCIFICATIONS REQUISES

- Laminate / Stratifié Included/Inclus
- Edge/Chant Included/Inclus
- Modesty Height/Hauteur du modestie Included/Inclus
- Grommets/Passe-fils Included/Inclus
- Metal leg/Patte en métal Included/Inclus

* GoCUID is generic to size and shape but not specific to orientation. Please specify accordingly

* GoCUID est générique pour la taille et la forme mais pas spécifique pour l'orientation. Veuillez spécifier en conséquence

Grand & Toy

E60PQ-140003/045/PQ

CATEGORY 1B - GABLE & WORK SURFACE SUPPORT - LICENCE

APPLICATION NOTES / INSTRUCTIONS D'APPLICATION

- When used against a panel or wall a modesty is not required
- When used perpendicular to a panel, wall, or open plan a modesty must be specified
- All hardware and supporting brackets included
- **Items marked with a " * " are an extended lead time of 6 weeks**
- Lorsqu'utilisé contre un panneau ou un mur, un panneau de modestie n'est pas requis
- Lorsqu'utilisé perpendiculaire à un panneau ou à un mur, un panneau de modestie doit être spécifié
- Tout le matériel et les supports sont inclus
- **Les articles marqués d'un " * " ont un délai de production de 6 semaines**

Free Standing Systems - Fixed Height Work Surfaces (Laminate) - Rectangular - 1 Work Surface Support, 1 Full Gable - Modesty (Laminate)
 Systèmes autoportants - Surfaces de travail à hauteur fixe (stratifié) - Rectangulaire - Un côté pleine hauteur - Panneau de modestie (stratifié)

Rectangle, Laminate Gable and Post Leg, Modesty / Rectangulaire, côté en stratifié et patte, panneau de modestie

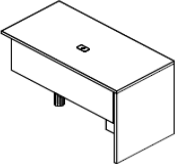
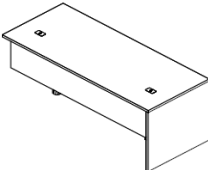
	GoCUID / CIUGdC	Price / Prix*	D/P	W/L	H	WT LB	CU
 Up to 48"W Jusqu'à 48 po L	1bFFHREF24L42WNOLNY	\$ 609.05	24	42	29		
	1bFFHREF24L48WNOLNY	\$ 642.85	24	48	29		
	1bFFHREF24L54WNOLNY	\$ 718.25	24	54	29		
	1bFFHREF24L60WNOLNY	\$ 750.75	24	60	29		
	1bFFHREF24L66WNOLNY	\$ 769.60	24	66	29		
	1bFFHREF24L72WNOLNY	\$ 790.40	24	72	29		
	1bFFHREF24L78WNOLNY	\$ 816.40	24	78	29		
	1bFFHREF24L84WNOLNY	\$ 845.65	24	84	29		
 54"W and longer 54 po L et plus	1bFFHREF30L54WNOLNY	\$ 741.65	30	54	29		
	1bFFHREF30L60WNOLNY	\$ 770.25	30	60	29		
	1bFFHREF30L66WNOLNY	\$ 789.75	30	66	29		
	1bFFHREF30L72WNOLNY	\$ 813.15	30	72	29		
	1bFFHREF30L78WNOLNY	\$ 837.85	30	78	29		
	1bFFHREF30L84WNOLNY	\$ 876.20	30	84	29		

*** Please contact for pricing/SVP nous contacter pour un prix**

REQUIRED SPECIFICATIONS / SPÉCIFICATIONS REQUISES

- | | |
|--------------------------------------|-----------------|
| - Laminate / Stratifié | Included/Inclus |
| - Edge/Chant | Included/Inclus |
| - Modesty Height/Hauteur du modestie | Included/Inclus |
| - Grommets/Passe-fils | Included/Inclus |
| - Round Leg/Patte ronde | Included/Inclus |

* upcharges are per complete table
 * les frais supplémentaires sont par table complète

ADDITIONAL OPTIONS / OPTIONS ADDITIONELLES

- | | |
|---|---------|
| - Chrome round leg/Patte ronde Chrome | \$61.10 |
| - Square Leg/Patte carrée | \$20.80 |
| - Square Leg Chrome/Patte carrée Chrome | \$75.40 |

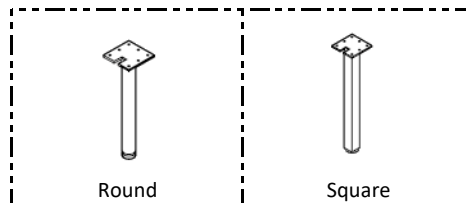

Rectangle, O Leg and Post Leg, Modesty / Rectangulaire, patte en O et patte, panneau de modestie

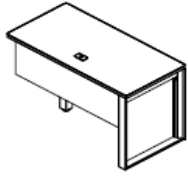

Up to 48"W
Jusqu'à 48 po L

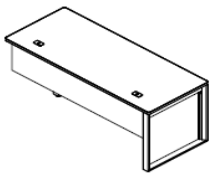

54"W and longer
54 po L et plus

GoCUID / CIUGdC	Price / Prix	D/P	W/L	H	WT LB	CU
1bFFHREF24L30WNOLNY	\$ 560.30	24	30	29	49	2.04
1bFFHREF24L36WNOLNY	\$ 572.00	24	36	29	55	2.21
1bFFHREF24L42WNOLNY	\$ 609.05	24	42	29	61	2.37
1bFFHREF24L48WNOLNY	\$ 642.85	24	48	29	65	2.53
1bFFHREF24L54WNOLNY	\$ 718.25	24	54	29	75	2.94
1bFFHREF24L60WNOLNY	\$ 750.75	24	60	29	212	3.10
1bFFHREF24L66WNOLNY	\$ 769.60	24	66	29	89	3.27
1bFFHREF24L72WNOLNY	\$ 790.40	24	72	29	95	3.47
1bFFHREF24L78WNOLNY	\$ 816.40	24	78	29	102	3.70
1bFFHREF24L84WNOLNY	\$ 845.65	24	84	29	109	3.91
1bFFHREF30L30WNOLNY	\$ 587.60	30	30	29	57	2.45
1bFFHREF30L36WNOLNY	\$ 605.80	30	36	29	63	2.68
1bFFHREF30L42WNOLNY	\$ 662.35	30	42	29	70	2.85
1bFFHREF30L48WNOLNY	\$ 679.25	30	48	29	76	3.05
1bFFHREF30L54WNOLNY	\$ 741.65	30	54	29	87	3.43
1bFFHREF30L60WNOLNY	\$ 770.25	30	60	29	95	3.65
1bFFHREF30L66WNOLNY	\$ 789.75	30	66	29	103	3.87
1bFFHREF30L72WNOLNY	\$ 813.15	30	72	29	110	4.09
1bFFHREF30L78WNOLNY	\$ 837.85	30	78	29	118	4.35
1bFFHREF30L84WNOLNY	\$ 876.20	30	84	29	126	4.60

REQUIRED SPECIFICATIONS / SPÉCIFICATIONS REQUISES

- Laminate / Stratifié Included/Inclus
- Edge/Chant Included/Inclus
- Modesty Height/Hauteur du modestie Included/Inclus
- Grommets/Passe-fils Included/Inclus
- Round Leg/Patte ronde Included/Inclus
- Metal leg/Patte en métal Included/Inclus

* upcharges are per complete table

* les frais supplémentaires sont par table complète

ADDITIONAL OPTIONS / OPTIONS ADDITIONELLES

- Chrome round leg/Patte ronde Chrome \$61.10
- Square Leg/Patte carrée \$20.80
- Square Leg Chrome/Patte carrée Chrome \$75.40

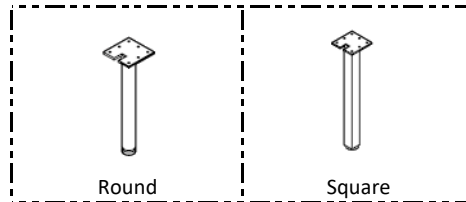

Grand & Toy

APPLICATION NOTES / INSTRUCTIONS D'APPLICATION

- All table units back-to-back count as a single surface length, i.e. 2 work surface lengths is 4 surfaces, 3 work surface lengths is 6 surfaces, etc.
- Divider screens are mandatory, choose between Fabric, Glazed, or Clear
- Tables include all power kits & duplex. It does not include feeds or jumpers, please specify as "HARDWARE"
- Dimensions are per surface not the overall length.
- Multiple units may be ordered to create runs of the desired length.

- Tous les ensembles de tables dos-à-dos comptent comme une seule longueur de surface ie longueur 2 surfaces totalise 4 surfaces
- Les écrans de séparation sont obligatoires. Choisissez entre tissu et verre transparent ou givré.
- Les tables incluent tous les blocs d'alimentation et les duplex. Elles n'incluent pas les conduits ou les cavaliers, spécifier "HARDWARE"
- Les dimensions sont par surface et non la longueur totale.
- Plusieurs ensembles peuvent être commandés pour créer des courses de la longueur souhaitée.

Free Standing Systems - Modular Benching Interconnectable (Laminate) - 2 Work Surface Long - Central Spine - Fabric Privacy

Systèmes autoporatnts - Surfaces de travail modulaires de type banquettes (stratifié) - Longueur de 2 surfaces de travail - Tranchée centrale - Écrans d'intimité en tissu

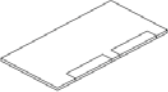
	GoCUID / CIUGdC	Price / Prix	D/P	W/L	H	WT LB	CU
 Surfaces 48" & 54"	1bFMB2LT24L48WFANYN	\$ 2,627.95	24	48	29	224	15.85
	1bFMB2LT24L54WFANYN	\$ 2,772.65	24	54	29	247	18.01
	1bFMB2LT24L60WFANYN	\$ 3,049.55	24	60	29	273	18.97
 Surfaces 60"	1bFMB2LT30L48WFANYN	\$ 2,806.50	30	48	29	260	19.26
	1bFMB2LT30L54WFANYN	\$ 2,979.80	30	54	29	287	19.96
	1bFMB2LT30L60WFANYN	\$ 3,290.50	30	60	29	317	21.84

REQUIRED SPECIFICATIONS / SPÉCIFICATIONS REQUISES

- Laminate / Stratifié Included/Inclus
- Painted Metal Leg/Patte en métal peint Included/Inclus
- Fabric / Tissu Gr. 1 Included/Inclus

ADDITIONAL OPTIONS / OPTIONS ADDITIONELLES

- 1- Anodized Aluminum Package \$ 76.05
- 2- End of Run O Leg Painted Package - 24"D \$ 87.10
- 3- End of Run O Leg Painted Package - 30"D \$ 92.30
- 4- End of Run O Leg Anodized Aluminum Package - 24"D \$ 163.15
- 5- End of Run O Leg Anodized Aluminum Package - 30"D \$ 168.35
- 6- White Duplex Package \$ 52.00
- 7- White Data/Comm Spacer Package \$ 78.00
- 8- Privacy Panel Fabric / en tissu GR2 - 48" \$ 36.40
- 9- Privacy Panel Fabric / en tissu GR 2 - 54" \$ 42.90
- 10- Privacy Panel Fabric / en tissu GR2 - 60" \$ 42.90

voir traduction française plus bas

* upcharges are per complete table

* les frais supplémentaires sont par table complète

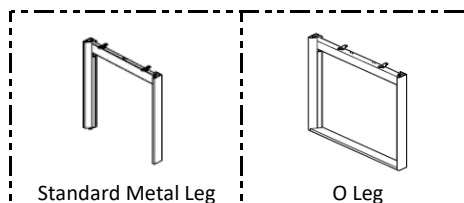
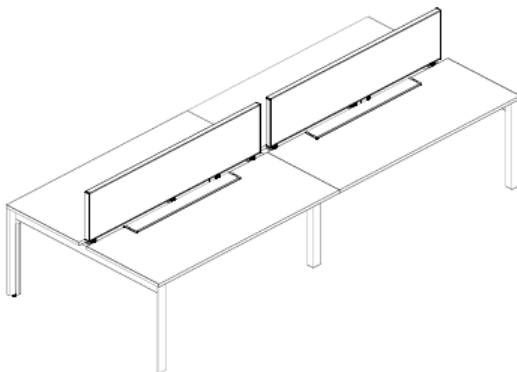

Free Standing Systems - Modular Benching Interconnectable (Laminate) - 2 Work Surface Long - Central Spine - Glass Frosted Privacy

Systèmes autoportants - Surfaces de travail modulaires de type banquettes (stratifié) - Longueur de 2 surfaces de travail - Tranchée centrale - Écrans d'intimité en verre givré

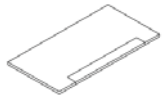

Surfaces 48" & 54"

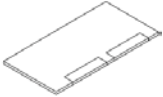

Surfaces 60"

GoCUID / CIUGdC	Price / Prix	D/P	W/L	H	WT LB	CU
1bFMB2LT24L48WFRNYN	\$ 2,695.65	24	48	29	222	13.55
1bFMB2LT24L54WFRNYN	\$ 2,865.95	24	54	29	245	15.39
1bFMB2LT24L60WFRNYN	\$ 3,086.95	24	60	29	271	16.07
1bFMB2LT30L48WFRNYN	\$ 2,874.20	30	48	29	258	16.96
1bFMB2LT30L54WFRNYN	\$ 3,073.10	30	54	29	285	17.34
1bFMB2LT30L60WFRNYN	\$ 3,327.90	30	60	29	315	18.94

Free Standing Systems - Modular Benching Interconnectable (Laminate) - 2 Work Surface Long - Central Spine - Glass Clear Privacy

Systèmes autoportants - Surfaces de travail modulaires de type banquettes (stratifié) - Longueur de 2 surfaces de travail - Tranchée centrale - Écrans d'intimité en verre transparent

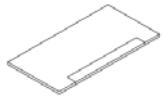

Surfaces 48" & 54"

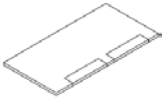

Surfaces 60"

GoCUID / CIUGdC	Price / Prix	D/P	W/L	H	WT LB	CU
1bFMB2LT24L48WCLNYN	\$ 2,695.65	24	48	29	222	13.55
1bFMB2LT24L54WCLNYN	\$ 2,865.95	24	54	29	245	15.39
1bFMB2LT24L60WCLNYN	\$ 3,086.95	24	60	29	271	16.07
1bFMB2LT30L48WCLNYN	\$ 2,874.20	30	48	29	258	16.96
1bFMB2LT30L54WCLNYN	\$ 3,073.10	30	54	29	285	17.34
1bFMB2LT30L60WCLNYN	\$ 3,327.90	30	60	29	315	18.94

REQUIRED SPECIFICATIONS / SPÉCIFICATIONS REQUISES

- Laminate / Stratifié Included/Inclus
- Painted Metal Leg/Patte en métal peint Included/Inclus

ADDITIONAL OPTIONS / OPTIONS ADDITIONELLES

- 1- Anodized Aluminum Package \$ 76.05
- 2- End of Run O Leg Painted Package - 24"D \$ 87.10
- 3- End of Run O Leg Painted Package - 30"D \$ 92.30
- 4- End of Run O Leg Anodized Aluminum Package - 24"D \$ 163.15
- 5- End of Run O Leg Anodized Aluminum Package - 30"D \$ 168.35
- 6- White Duplex Package \$ 52.00
- 7- White Data/Comm Spacer Package \$ 78.00

voir traduction française plus bas

* upcharges are per complete table

* les frais supplémentaires sont par table complète

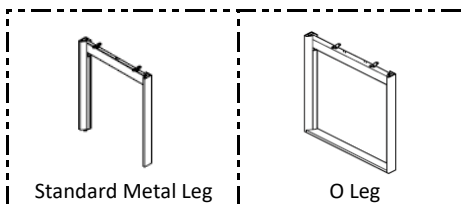
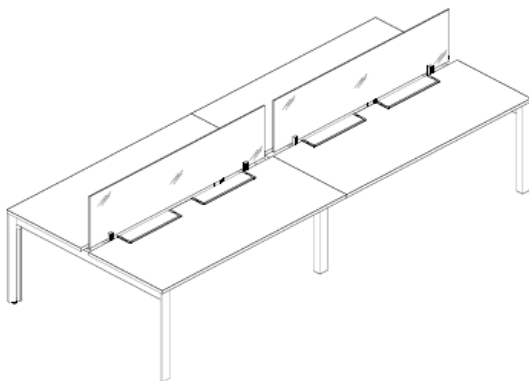

Free Standing Systems - Modular Benching Interconnectable (Laminate) - 3 Work Surface Long - Central Spine - Fabric Privacy

Systèmes autoportants - Surfaces de travail modulaires de type banquettes (stratifié) - Longueur de 3 surfaces de travail - Tranchée centrale - Écrans d'intimité en tissu

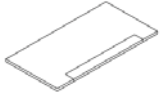

Surfaces 48" & 54"



Surfaces 60"

GoCUID / CIUGdC	Price / Prix	D/P	W/L	H	WT LB	CU
1bFMB3LT24L48WFANYN	\$ 3,890.30	24	48	29	329	23.58
1bFMB3LT24L54WFANYN	\$ 4,089.80	24	54	29	364	25.29
1bFMB3LT24L60WFANYN	\$ 4,505.15	24	60	29	403	26.73
1bFMB3LT30L48WFANYN	\$ 4,141.65	30	48	29	383	27.16
1bFMB3LT30L54WFANYN	\$ 4,401.60	30	54	29	424	28.21
1bFMB3LT30L60WFANYN	\$ 4,861.80	30	60	29	469	31.03

REQUIRED SPECIFICATIONS / SPÉCIFICATIONS REQUISES

- Laminate / Stratifié Included/Inclus
- Painted Metal Leg/Patte en métal peint Included/Inclus
- Fabric / Tissu Gr. 1 Included/Inclus

ADDITIONAL OPTIONS / OPTIONS ADDITIONELLES

- 1- Anodized Aluminum Package \$ 101.40
- 2- End of Run O Leg Painted Package - 24"D \$ 87.10
- 3- End of Run O Leg Painted Package - 30"D \$ 92.30
- 4- End of Run O Leg Anodized Aluminum Package - 24"D \$ 188.50
- 5- End of Run O Leg Anodized Aluminum Package - 30"D \$ 193.70
- 6- White Duplex Package \$ 78.00
- 7- White Data/Comm Spacer Package \$ 117.00
- 8- Privacy Panel Fabric / en tissu GR2 - 48" \$ 54.60
- 9- Privacy Panel Fabric / en tissu GR 2 - 54" \$ 64.35
- 10- Privacy Panel Fabric / en tissu GR2 - 60" \$ 64.35

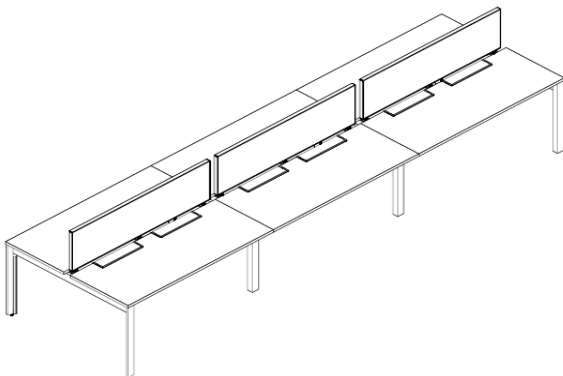

- 1- Aluminium anodisé
- 2- Patte en O peinte, fin de course - 24 po P
- 3- Patte en O peinte, fin de course - 30 po P
- 4- Patte en O Aluminium anodisé, fin de course - 24 po P
- 5- Patte en O Aluminium anodisé, fin de course - 30 po P
- 6- Duplex Blanc
- 7- Espaceur élec/données Blanc
- 8- Écran de séparation / Tissu Gr. 2 - 48 po
- 9- Écran de séparation / Tissu Gr. 2 - 54 po
- 10- Écran de séparation / Tissu Gr. 2 - 60 po

* upcharges are per complete table

* les frais supplémentaires sont par table complète

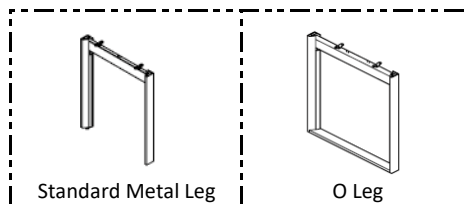

Free Standing Systems - Modular Benching Interconnectable (Laminate) - 3 Work Surface Long - Central Spine - Glass Frosted Privacy

Systèmes autoportants - Surfaces de travail modulaires de type banquettes (stratifié) - Longueur de 3 surfaces de travail - Tranchée centrale - Écrans d'intimité en verre gravé

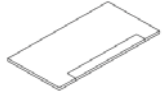

Surfaces 48" & 54"



Surfaces 60"

GoCUID / CIUGdC	Price / Prix	D/P	W/L	H	WT LB	CU
1bFMB3LT24L48WFRNYN	\$ 3,974.30	24	48	29	326	20.13
1bFMB3LT24L54WFRNYN	\$ 4,229.75	24	54	29	361	21.36
1bFMB3LT24L60WFRNYN	\$ 4,561.25	24	60	29	400	22.38
1bFMB3LT30L48WFRNYN	\$ 4,243.20	30	48	29	380	23.71
1bFMB3LT30L54WFRNYN	\$ 4,541.55	30	54	29	421	24.28
1bFMB3LT30L60WFRNYN	\$ 4,917.90	30	60	29	466	26.68

Free Standing Systems - Modular Benching Interconnectable (Laminate) - 3 Work Surface Long - Central Spine - Glass Clear Privacy

Systèmes autoportants - Surfaces de travail modulaires de type banquettes (stratifié) - Longueur de 3 surfaces de travail - Tranchée centrale - Écrans d'intimité en verre transparent

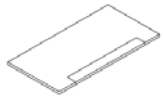

Surfaces 48" & 54"

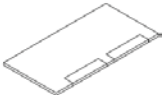

Surfaces 60"

GoCUID / CIUGdC	Price / Prix	D/P	W/L	H	WT LB	CU
1bFMB3LT24L48WCLNYN	\$ 3,974.30	24	48	29	326	20.13
1bFMB3LT24L54WCLNYN	\$ 4,229.75	24	54	29	361	21.36
1bFMB3LT24L60WCLNYN	\$ 4,561.25	24	60	29	400	22.38
1bFMB3LT30L48WCLNYN	\$ 4,243.20	30	48	29	380	23.71
1bFMB3LT30L54WCLNYN	\$ 4,541.55	30	54	29	421	24.28
1bFMB3LT30L60WCLNYN	\$ 4,917.90	30	60	29	466	26.68

REQUIRED SPECIFICATIONS / SPÉCIFICATIONS REQUISES

- Laminate / Stratifié Included/Inclus
- Painted Metal Leg/Patte en métal peint Included/Inclus

ADDITIONAL OPTIONS / OPTIONS ADDITIONELLES

- 1- Anodized Aluminum Package \$ 101.40
- 2- End of Run O Leg Painted Package - 24"D \$ 87.10
- 3- End of Run O Leg Painted Package - 30"D \$ 92.30
- 4- End of Run O Leg Anodized Aluminum Package - 24"D \$ 188.50
- 5- End of Run O Leg Anodized Aluminum Package - 30"D \$ 193.70
- 6- White Duplex Package \$ 78.00
- 7- White Data/Comm Spacer Package \$ 117.00

voir traduction française plus bas

* upcharges are per complete table

* les frais supplémentaires sont par table complète

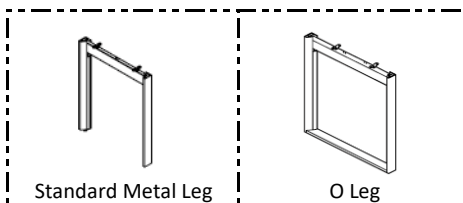
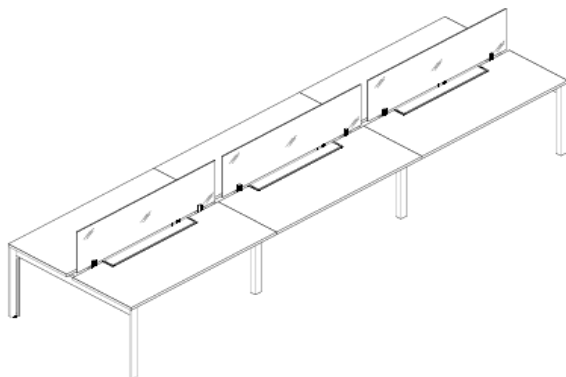

Free Standing Systems - Modular Benching Interconnectable (Laminate) - 4 Work Surface Long - Central Spine - Fabric Privacy

Systèmes autoportants - Surfaces de travail modulaires de type banquettes (stratifié) - Longueur de 4 surfaces de travail - Tranchée centrale - Écrans d'intimité en tissu

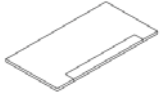

Surfaces 48" & 54"

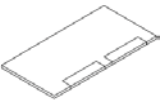

Surfaces 60"

GoCUID / CIUGdC	Price / Prix	D/P	W/L	H	WT LB	CU
1bFMB4LT24L48WFANYN	\$ 5,140.95	24	48	29	434	30.29
1bFMB4LT24L54WFANYN	\$ 5,406.95	24	54	29	480	32.57
1bFMB4LT24L60WFANYN	\$ 5,960.75	24	60	29	532	34.49
1bFMB4LT30L48WFANYN	\$ 5,476.80	30	48	29	506	35.06
1bFMB4LT30L54WFANYN	\$ 5,823.40	30	54	29	560	36.46
1bFMB4LT30L60WFANYN	\$ 6,444.80	30	60	29	620	40.22

REQUIRED SPECIFICATIONS / SPÉCIFICATIONS REQUISES

- Laminate / Stratifié Included/Inclus
- Painted Metal Leg/Patte en métal peint Included/Inclus
- Fabric / Tissu Gr. 1 Included/Inclus

ADDITIONAL OPTIONS / OPTIONS ADDITIONELLES

- 1- Anodized Aluminum Package \$ 126.75
- 2- End of Run O Leg Painted Package - 24"D \$ 87.10
- 3- End of Run O Leg Painted Package - 30"D \$ 92.30
- 4- End of Run O Leg Anodized Aluminum Package - 24"D \$ 213.85
- 5- End of Run O Leg Anodized Aluminum Package - 30"D \$ 219.05
- 6- White Duplex Package \$ 104.00
- 7- White Data/Comm Spacer Package \$ 156.00
- 8- Privacy Panel Fabric / en tissu GR2 - 48" \$ 72.80
- 9- Privacy Panel Fabric / en tissu GR 2 - 54" \$ 85.80
- 10- Privacy Panel Fabric / en tissu GR2 - 60" \$ 85.80

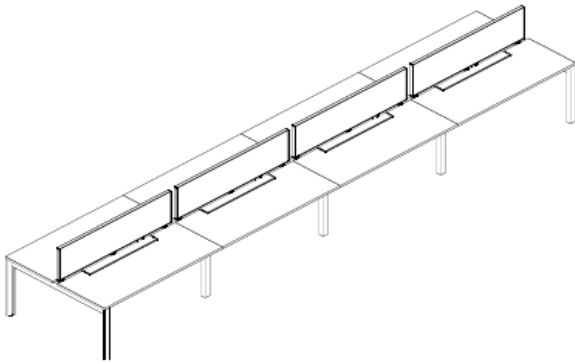

- 1- Aluminium anodisé
- 2- Patte en O peinte, fin de course - 24 po P
- 3- Patte en O peinte, fin de course - 30 po P
- 4- Patte en O Aluminium anodisé, fin de course - 24 po P
- 5- Patte en O Aluminium anodisé, fin de course - 30 po P
- 6- Duplex Blanc
- 7- Espaceur élec/données Blanc
- 8- Écran de séparation / Tissu Gr. 2 - 48 po
- 9- Écran de séparation / Tissu Gr. 2 - 54 po
- 10- Écran de séparation / Tissu Gr. 2 - 60 po

* upcharges are per complete table

* les frais supplémentaires sont par table complète

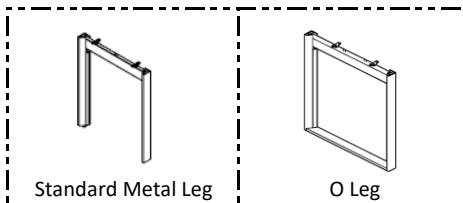

Free Standing Systems - Modular Benching Interconnectable (Laminate) - 4 Work Surface Long - Central Spine - Glass Frosted Privacy

Systèmes autoportants - Surfaces de travail modulaires de type banquettes (stratifié) - Longueur de 4 surfaces de travail - Tranchée centrale - Écrans d'intimité en verre gravé

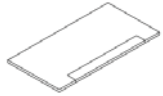

Surfaces 48" & 54"

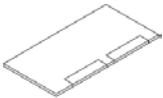

Surfaces 60"

GoCUID / CIUGdC	Price / Prix	D/P	W/L	H	WT LB	CU
1bFMB4LT24L48WFRNYN	\$ 5,252.95	24	48	29	430	25.69
1bFMB4LT24L54WFRNYN	\$ 5,593.55	24	54	29	476	27.33
1bFMB4LT24L60WFRNYN	\$ 6,035.55	24	60	29	528	28.69
1bFMB4LT30L48WFRNYN	\$ 5,612.20	30	48	29	502	30.46
1bFMB4LT30L54WFRNYN	\$ 6,010.00	30	54	29	556	31.22
1bFMB4LT30L60WFRNYN	\$ 6,519.60	30	60	29	616	34.42

Free Standing Systems - Modular Benching Interconnectable (Laminate) - 4 Work Surface Long - Central Spine - Glass Clear Privacy

Systèmes autoportants - Surfaces de travail modulaires de type banquettes (stratifié) - Longueur de 4 surfaces de travail - Tranchée centrale - Écrans d'intimité en verre transparent

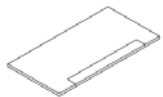

Surfaces 48" & 54"

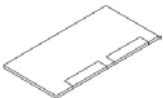

Surfaces 60"

GoCUID / CIUGdC	Price / Prix	D/P	W/L	H	WT LB	CU
1bFMB4LT24L48WCLNYN	\$ 5,252.95	24	48	29	430	25.69
1bFMB4LT24L54WCLNYN	\$ 5,593.55	24	54	29	476	27.33
1bFMB4LT24L60WCLNYN	\$ 6,035.55	24	60	29	528	28.69
1bFMB4LT30L48WCLNYN	\$ 5,612.20	30	48	29	502	30.46
1bFMB4LT30L54WCLNYN	\$ 6,010.00	30	54	29	556	31.22
1bFMB4LT30L60WCLNYN	\$ 6,519.60	30	60	29	616	34.42

REQUIRED SPECIFICATIONS / SPÉCIFICATIONS REQUISES

- Laminate / Stratifié Included/Inclus
- Painted Metal Leg/Patte en métal peint Included/Inclus

ADDITIONAL OPTIONS / OPTIONS ADDITIONELLES

- 1- Anodized Aluminum Package \$ 126.75
- 2- End of Run O Leg Painted Package - 24"D \$ 87.10
- 3- End of Run O Leg Painted Package - 30"D \$ 92.30
- 4- End of Run O Leg Anodized Aluminum Package - 24"D \$ 213.85
- 5- End of Run O Leg Anodized Aluminum Package - 30"D \$ 219.05
- 6- White Duplex Package \$ 104.00
- 7- White Data/Comm Spacer Package \$ 156.00

voir traduction française plus haut

* upcharges are per complete table

* les frais supplémentaires sont par table complète

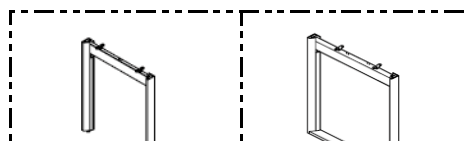
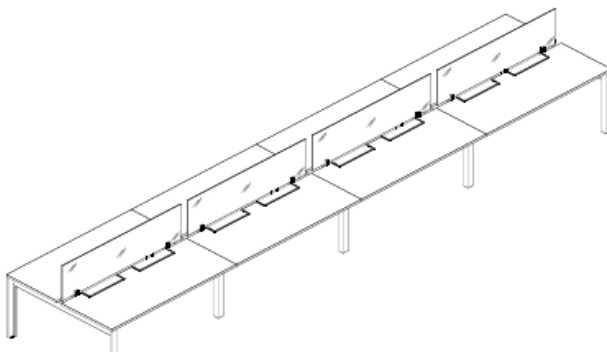

Grand & Toy

E60PQ-140003/045/PQ

CATEGORY 1B - MODULAR BENCHING - BRIDGES

Standard Metal Leg

O Leg

APPLICATION NOTES / INSTRUCTIONS D'APPLICATION

SAMPLE APPLICATION / EXEMPLE D'APPLICATION

- May be used in work space, collaborative, meeting, and kitchen or staff areas
- Tables in Category 1B do not have power or data. For power and data please use Category 6.
- All hardware and supporting brackets included.
- Peut être utilisé dans les espaces de travail, de collaboration, de réunion, de cuisine ou de personnel
- Les tables de la catégorie 1B n'ont pas d'alimentation électrique/données.
- Pour avoir cette option, utiliser la catégorie 6.
- Tout le matériel et les supports sont inclus.

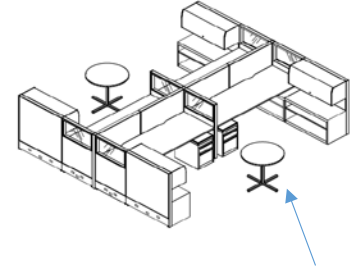

Free Standing Systems - Meeting Tables (Laminate) - Pedestal
 Systèmes autoportants - Tables de réunion (stratifié) - Piétement

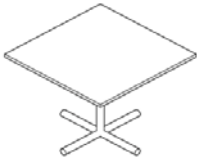
	<i>GoCUID / CIUGdC*</i>	<i>Price / Prix</i>	<i>D/P</i>	<i>W/L</i>	<i>H</i>	<i>WT LB</i>	<i>CU</i>
	Round / Ronde		30	30	29	35	10.00
	1bFMTROP30XXXWNONNN	\$ 345.80	30	30	29	35	10.00
	1bFMTROP36XXXWNONNN	\$ 338.65	36	36	29	42	10.00
	1bFMTROP42XXXWNONNN	\$ 407.55	42	42	29	52	11.00
	Square / Carrée						
	1bFMTSQP30L30WNONNN	\$ 335.40	30	30	29	38	10.00
	1bFMTSQP36L36WNONNN	\$ 403.65	36	36	29	46	11.00
	1bFMTSQP42L42WNONNN	\$ 475.80	42	42	29	57	11.00

REQUIRED SPECIFICATIONS / SPÉCIFICATIONS REQUISES

- Laminate / Stratifié
- Four Prong Metal Base Paint / Piétement métallique peint à quatre branches

ADDITIONAL OPTIONS / OPTIONS ADDITIONELLES

- Chrome 30", 36", 42"	\$ 54.60
- Disc Painted / Disque peint : 30"	\$ 117.00
- Disc Painted / Disque peint : 36"	\$ 174.20
- Disc Painted / Disque peint : 42"	\$ 346.45
- Disc Chrome / Disque Chrome : 30"	\$ 185.25
- Disc Chrome / Disque Chrome : 36"	\$ 242.45
- Disc Chrome / Disque Chrome : 42"	\$ 375.05
- Flat X Bar Painted / X plat peint : 30"	\$ 296.40
- Flat X Bar Painted / X plat peint : 36"	\$ 303.55
- Flat X Bar Painted / X plat peint : 42"	\$ 301.60

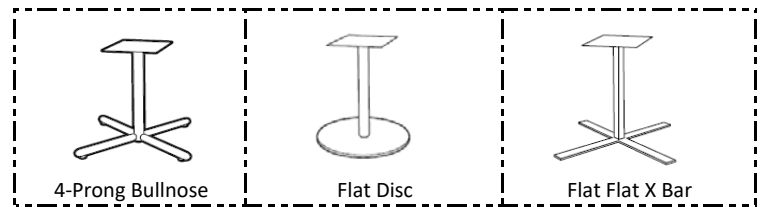

* upcharges are per complete table
 * les frais supplémentaires sont par table complète

- Flat X Bar Chrome / X plat Chrome : 30"	\$391.95
- Flat X Bar Chrome / X plat Chrome : 36"	\$399.10
- Flat X Bar Chrome / X plat Chrome : 42"	\$383.50

Grand & Toy

E60PQ-140003/045/PQ

CATEGORY 1B - MEETING TABLES - LICENCE

Free Standing Systems - Meeting Tables (Laminate) - 4 Post Legs

Systèmes autoportants - Tables de réunion (stratifié) - 4 pattes

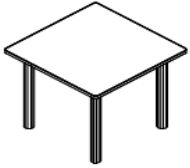

GoCUID / CIUGdC*

	Price / Prix	D/P	W/L	H	WT LB	CU
Square / Carrée	\$ 469.30	36	36	29	82	4.68
1bFMTSQL36L36WNONNN	\$ 469.30	36	36	29	82	4.68
1bFMTSQL42L42WNONNN	\$ 540.80	42	42	29	93	6.68

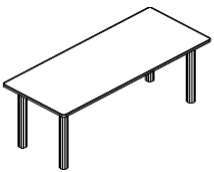

Rectangle

1bFMTREL30L60WNONNN	\$ 560.30	30	60	29	84	3.68
1bFMTREL30L66WNONNN	\$ 572.00	30	66	29	89	3.68
1bFMTREL30L72WNONNN	\$ 588.25	30	72	29	93	3.68

REQUIRED SPECIFICATIONS / SPÉCIFICATIONS REQUISES

- Laminate / Stratifié Included/Inclus
- Edge/Chant Included/Inclus
- Round Leg/Patte ronde Included/Inclus

ADDITIONAL OPTIONS / OPTIONS ADDITIONELLES

- Chrome round leg/Patte ronde Chrome \$ 244.40
- Tapered Leg/Patte fuselée \$ 10.40
- Tapered Leg Chrome/Patte fuselée Chrome \$ 239.20
- Square Leg/Patte carrée \$ 83.20
- Square Leg Chrome/Patte carrée Chrome \$ 301.60

* upcharges are per complete table

* les frais supplémentaires sont par table complète

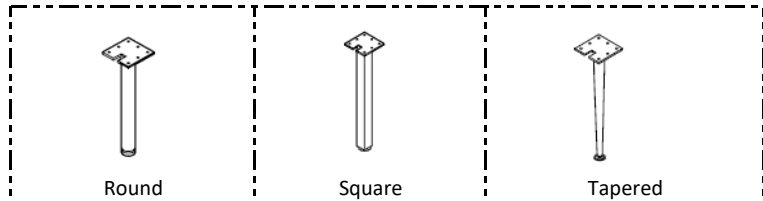

Free Standing Systems - Meeting Tables (Laminate) - Rectangular - Panel Bases

Systèmes autoportants - Tables de réunion (stratifié) - Rectangulaire - Piétements panneaux

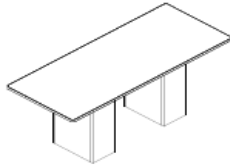

GoCUID / CIUGdC*	Price / Prix	D/P	W/L	H	WT LB	CU
1bFMTREB30L60WNONNN	\$ 587.60	30	60	29	126	9.00
1bFMTREB30L66WNONNN	\$ 596.70	30	66	29	131	9.00
1bFMTREB30L72WNONNN	\$ 609.05	30	72	29	135	9.00

REQUIRED SPECIFICATIONS / SPÉCIFICATIONS REQUISES

- Laminate / Stratifié Included/Inclus
- Edge / Chant Included/Inclus
- Base (LR) Included/Inclus

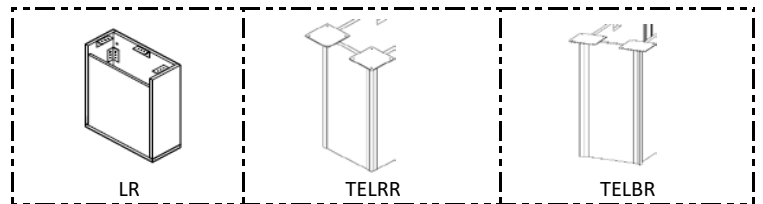

ADDITIONAL OPTIONS / OPTIONS ADDITIONELLES

- Anodized Aluminum Radius Corner Detail (TELRR)/ Piétement à arêtes arrondies en Aluminium anodisé \$ 261.30
- Anodized Aluminum Corner Detail (TELBR)/ Piétement à arêtes rectangulaires en aluminium anodisé \$ 283.40

* upcharges are per complete table
* les frais supplémentaires sont par table complète

Free Standing Systems - Meeting Tables (Laminate) - Rectangular - Panel Bases

Systèmes autoportants - Tables de réunion (stratifié) - Rectangulaire - Piétements panneaux

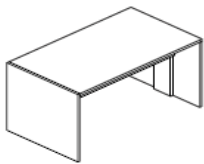

GoCUID / CIUGdC*	Price / Prix	D/P	W/L	H	WT LB	CU
1bFMTREG30L60WNONNN	\$ 787.80	30	60	29.5	171	13.00
1bFMTREG30L66WNONNN	\$ 821.60	30	66	29.5	180	14.00
1bFMTREG30L72WNONNN	\$ 856.05	30	72	29.5	189	15.00

REQUIRED SPECIFICATIONS / SPÉCIFICATIONS REQUISES

- Laminate / Stratifié Included/Inclus
- Edge / Chant Included/Inclus

Grand & Toy

E60PQ-140003/045/PQ

CATEGORY 1B - MEETING TABLES - LICENCE

APPLICATION NOTES / INSTRUCTIONS D'APPLICATION

- Matches the height of other Licence 29"H casegoods with B edge detail
- When used with a hutch the total height combined can not exceed 66"H
- Units are handed, please select left or right configurations as required
- Will not work with floating tops and spacers, please use Partial Height Credenzas for this application
- Configurations shown are for reference only and may differ based on size
- Option for Keyed or E-Lock, please see product descriptions
- **Items marked with a " * " are an extended lead time of 6 weeks**

- Se coordonne à la hauteur d'autres modules Licence 29 po H avec un chant B
- Lorsqu'utilisé avec une huche, la hauteur totale combinée ne peut pas dépasser 66 po H
- Les modules ne sont pas réversibles, sélectionner une configuration gauche ou droite, selon vos besoins
- N'est pas compatible pas avec les surfaces chevauchantes et espaceurs, veuillez utiliser des crédences à hauteur partielle pour cette application
- Les configurations présentées sont à titre de référence seulement et peuvent différer en fonction de la taille
- Option serrure à clé ou électronique, voir les descriptions de produits
- **Les articles marqués d'un " * " ont un délai de production de 6 semaines**

* Please note the GoCUID used for this product is also applicable for other product combinations. The price shown is specific to the combination of components therein and may be shown below Ceiling Price.

* Veuillez noter que le GoCUID utilisé pour ce produit est également applicable à d'autres combinaisons de produits. Le prix indiqué est spécifique à la combinaison des composants et peut être inférieur au prix plafond

Credenza - Full Height - Laminate

Crédence - Pleine hauteur - Stratifié

Open Shelf / Étagère ouverte

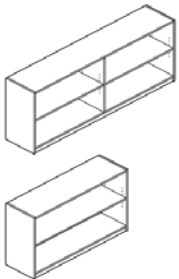

GoCUID / CIUGdC*	Price / Prix	D/P	W/L	H	WT LB	CU
1bCFHLX20L42XOSOSX*	\$ 618.15	20	42	29	297	12.00
1bCFHLX20L48XOSOSX*	\$ 929.50	20	48	29	319	18.00
1bCFHLX20L60XOSOSX*	\$ 1,005.55	20	60	29	341	24.00
1bCFHLX20L72XOSOSX*	\$ 1,085.50	20	72	29	363	30.00
1bCFHLX24L42XOSOSX*	\$ 642.85	24	42	29	297	12.00
1bCFHLX24L48XOSOSX*	\$ 929.50	24	48	29	319	18.00
1bCFHLX24L60XOSOSX*	\$ 1,073.15	24	60	29	341	24.00
1bCFHLX24L72XOSOSX*	\$ 1,435.85	24	72	29	363	30.00

REQUIRED SPECIFICATIONS / SPÉCIFICATIONS REQUISES

- Laminate / Stratifié
- Included/Inclus

Door - Open Shelf / Porte + étagère ouverte

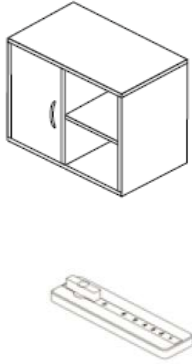

GoCUID / CIUGdC*	Price / Prix	D/P	W/L	H	WT LB	CU
1bCFHLX20L42XOSDDXS*	\$ 618.15	20	42	29	297	12.00
1bCFHLX20L48XOSDDXS*	\$ 943.80	20	48	29	319	18.00
1bCFHLX20L60XOSDDXS*	\$ 1,005.55	20	60	29	341	24.00
1bCFHLX20L72XOSDDXS*	\$ 1,085.50	20	72	29	363	30.00
1bCFHLX24L42XOSDDXS*	\$ 642.85	24	42	29	297	12.00
1bCFHLX24L48XOSDDXS*	\$ 929.50	24	48	29	319	18.00
1bCFHLX24L60XOSDDXS*	\$ 1,073.15	24	60	29	341	24.00
1bCFHLX24L72XOSDDXS*	\$ 1,435.85	24	72	29	363	30.00
1bCFHLX20L42XOSDDXK*	\$ 722.15	20	42	29	297	12.00
1bCFHLX20L48XOSDDXK*	\$ 1,047.80	20	48	29	319	18.00
1bCFHLX20L60XOSDDXK*	\$ 1,109.55	20	60	29	341	24.00
1bCFHLX20L72XOSDDXK*	\$ 1,189.50	20	72	29	363	30.00
1bCFHLX24L42XOSDDXK*	\$ 746.85	24	42	29	297	12.00
1bCFHLX24L48XOSDDXK*	\$ 1,033.50	24	48	29	319	18.00
1bCFHLX24L60XOSDDXK*	\$ 1,177.15	24	60	29	341	24.00
1bCFHLX24L72XOSDDXK*	\$ 1,539.85	24	72	29	363	30.00

Key / Cle

Electronic / Électronique

Open Shelf - Door / Étagère ouverte + porte

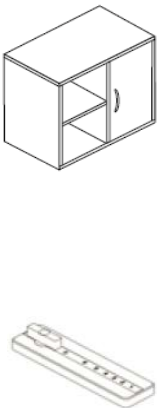

GoCUID / CIUGdC*	Price / Prix	D/P	W/L	H	WT LB	CU
1bCFHLX20L42XDDOSXS*	\$ 618.15	20	42	29	297	12.00
1bCFHLX20L48XDDOSXS*	\$ 943.80	20	48	29	319	18.00
1bCFHLX20L60XDDOSXS*	\$ 1,005.55	20	60	29	341	24.00
1bCFHLX20L72XDDOSXS*	\$ 1,085.50	20	72	29	363	30.00
1bCFHLX24L42XDDOSXS*	\$ 642.85	24	42	29	297	12.00
1bCFHLX24L48XDDOSXS*	\$ 929.50	24	48	29	319	18.00
1bCFHLX24L60XDDOSXS*	\$ 1,073.15	24	60	29	341	24.00
1bCFHLX24L72XDDOSXS*	\$ 1,435.85	24	72	29	363	30.00
1bCFHLX20L42XDDOSXK*	\$ 618.15	20	42	29	297	12.00
1bCFHLX20L48XDDOSXK*	\$ 943.80	20	48	29	319	18.00
1bCFHLX20L60XDDOSXK*	\$ 1,005.55	20	60	29	341	24.00
1bCFHLX20L72XDDOSXK*	\$ 1,085.50	20	72	29	363	30.00
1bCFHLX24L42XDDOSXK*	\$ 642.85	24	42	29	297	12.00
1bCFHLX24L48XDDOSXK*	\$ 929.50	24	48	29	319	18.00
1bCFHLX24L60XDDOSXK*	\$ 1,073.15	24	60	29	341	24.00
1bCFHLX24L72XDDOSXK*	\$ 1,435.85	24	72	29	363	30.00

Key / Cle

Electronic / Électronique

REQUIRED SPECIFICATIONS / SPÉCIFICATIONS REQUISES

- Laminate / Stratifié Included/Inclus
- Handle / Poignée Included/Inclus

Door / Portes

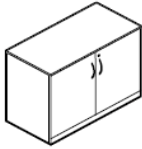
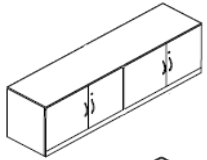

GoCUID / CIUGdC*	Price / Prix	D/P	W/L	H	WT LB	CU
1bCFHLX20L42XDDDDXS	\$ 618.15	20	42	29	297	12.00
1bCFHLX20L48XDDDDXS*	\$ 1,005.55	20	48	29	319	18.00
1bCFHLX20L60XDDDDXS	\$ 1,005.55	20	60	29	341	24.00
1bCFHLX20L72XDDDDXS	\$ 1,085.50	20	72	29	363	30.00
1bCFHLX24L42XDDDDXS	\$ 642.85	24	42	29	297	12.00
1bCFHLX24L48XDDDDXS*	\$ 929.50	24	48	29	319	18.00
1bCFHLX24L60XDDDDXS	\$ 1,046.50	24	60	29	341	24.00
1bCFHLX24L72XDDDDXS	\$ 1,129.05	24	72	29	363	30.00
1bCFHLX20L42XDDDDXK	\$ 722.15	20	42	29	297	12.00
1bCFHLX20L48XDDDDXK*	\$ 1,109.55	20	48	29	319	18.00
1bCFHLX20L60XDDDDXK	\$ 1,109.55	20	60	29	341	24.00
1bCFHLX20L72XDDDDXK	\$ 1,293.50	20	72	29	363	30.00
1bCFHLX24L42XDDDDXK	\$ 746.85	24	42	29	297	12.00
1bCFHLX24L48XDDDDXK*	\$ 1,137.50	24	48	29	319	18.00
1bCFHLX24L60XDDDDXK	\$ 1,254.50	24	60	29	341	24.00
1bCFHLX24L72XDDDDXK	\$ 1,337.05	24	72	29	363	30.00

Key / Cle

Electronic / Électronique

Box/File Drawer - Open Shelf / Tiroirs utilité/tiroir classeur + étagère ouverte

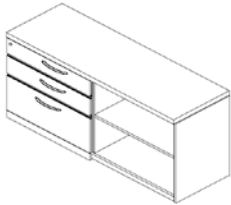

GoCUID / CIUGdC*	Price / Prix	D/P	W/L	H	WT LB	CU
1bCFHLX20L42XOSBFXS*	\$ 977.60	20	42	29	325	12.00
1bCFHLX20L48XOSBFXS*	\$ 1,017.25	20	48	29	355	18.00
1bCFHLX20L60XOSBFXS*	\$ 1,541.15	20	60	29	385	24.00
1bCFHLX20L72XOSBFXS*	\$ 1,478.10	20	72	29	418	30.00
1bCFHLX24L42XOSBFXS*	\$ 1,004.90	24	42	29	325	12.00
1bCFHLX24L48XOSBFXS*	\$ 1,046.50	24	48	29	355	18.00
1bCFHLX24L60XOSBFXS*	\$ 1,427.40	24	60	29	385	24.00
1bCFHLX24L72XOSBFXS*	\$ 1,280.50	24	72	29	418	30.00
1bCFHLX20L42XOSBFXK*	\$ 1,081.60	20	42	29	325	12.00
1bCFHLX20L48XOSBFXK*	\$ 1,121.25	20	48	29	355	18.00
1bCFHLX20L60XOSBFXK*	\$ 1,645.15	20	60	29	385	24.00
1bCFHLX20L72XOSBFXK*	\$ 1,582.10	20	72	29	418	30.00
1bCFHLX24L42XOSBFXK*	\$ 1,108.90	24	42	29	325	12.00
1bCFHLX24L48XOSBFXK*	\$ 1,150.50	24	48	29	355	18.00
1bCFHLX24L60XOSBFXK*	\$ 1,531.40	24	60	29	385	24.00
1bCFHLX24L72XOSBFXK*	\$ 1,640.60	24	72	29	418	30.00

Key / Cle

Electronic / Électronique

REQUIRED SPECIFICATIONS / SPÉCIFICATIONS REQUISES

- Laminate / Stratifié

Included/Inclus

Grand & Toy

E60PQ-140003/045/PQ

CATEGORY 1B - CREDENZAS - FULL HEIGHT - LICENCE

- Handle / Poignée

Included/Inclus

Open Shelf - Box/File Drawer / Étagère ouverte + tiroirs utilité/tiroir classeur

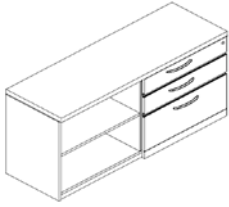

GoCUID / CIUGdC*	Price / Prix	D/P	W/L	H	WT LB	CU
1bCFHLX20L42XBFOXS*	\$ 977.60	20	42	29	325	12.00
1bCFHLX20L48XBFOXS*	\$ 1,017.25	20	48	29	355	18.00
1bCFHLX20L60XBFOXS*	\$ 1,541.15	20	60	29	385	24.00
1bCFHLX20L72XBFOXS*	\$ 1,478.10	20	72	29	418	30.00
1bCFHLX24L42XBFOXS*	\$ 1,004.90	24	42	29	325	12.00
1bCFHLX24L48XBFOXS*	\$ 1,046.50	24	48	29	355	18.00
1bCFHLX24L60XBFOXS*	\$ 1,427.40	24	60	29	385	24.00
1bCFHLX24L72XBFOXS*	\$ 1,280.50	24	72	29	418	30.00

Key / Cle

1bCFHLX20L42XBFOXS*	\$ 1,081.60	20	42	29	325	12.00
1bCFHLX20L48XBFOXS*	\$ 1,121.25	20	48	29	355	18.00
1bCFHLX20L60XBFOXS*	\$ 1,580.80	20	60	29	385	24.00
1bCFHLX20L72XBFOXS*	\$ 1,582.10	20	72	29	418	30.00
1bCFHLX24L42XBFOXS*	\$ 1,258.40	24	42	29	325	12.00
1bCFHLX24L48XBFOXS*	\$ 1,476.80	24	48	29	355	18.00
1bCFHLX24L60XBFOXS*	\$ 1,531.40	24	60	29	385	24.00
1bCFHLX24L72XBFOXS*	\$ 1,640.60	24	72	29	418	30.00

Electronic / Électronique

Box/File Drawer / Tiroirs utilité/tiroirs classeur

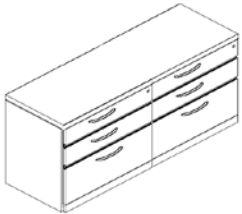

GoCUID / CIUGdC*	Price / Prix	D/P	W/L	H	WT LB	CU
1bCFHLX20L42XBFBFXS*	\$ 903.50	20	42	29	325	12.00
1bCFHLX20L48XBFBFXS*	\$ 1,303.90	20	48	29	355	18.00
1bCFHLX20L60XBFBFXS*	\$ 1,541.15	20	60	29	385	24.00
1bCFHLX20L72XBFBFXS*	\$ 1,656.85	20	72	29	418	30.00
1bCFHLX24L42XBFBFXS*	\$ 939.25	24	42	29	325	12.00
1bCFHLX24L48XBFBFXS*	\$ 1,602.90	24	48	29	355	18.00
1bCFHLX24L60XBFBFXS*	\$ 1,602.90	24	60	29	385	24.00
1bCFHLX24L72XBFBFXS*	\$ 1,723.15	24	72	29	418	30.00

Key / Cle

1bCFHLX20L42XBFBFXK*	\$ 1,111.50	20	42	29	325	12.00
1bCFHLX20L48XBFBFXK*	\$ 1,511.90	20	48	29	355	18.00
1bCFHLX20L60XBFBFXK*	\$ 1,749.15	20	60	29	385	24.00
1bCFHLX20L72XBFBFXK*	\$ 1,864.85	20	72	29	418	30.00
1bCFHLX24L42XBFBFXK*	\$ 1,043.25	24	42	29	325	12.00
1bCFHLX24L48XBFBFXK*	\$ 1,810.90	24	48	29	355	18.00
1bCFHLX24L60XBFBFXK*	\$ 1,810.90	24	60	29	385	24.00
1bCFHLX24L72XBFBFXK*	\$ 1,931.15	24	72	29	418	30.00

Electronic / Électronique

REQUIRED SPECIFICATIONS / SPÉCIFICATIONS REQUISES

Grand & Toy

E60PQ-140003/045/PQ

CATEGORY 1B - CREDENZAS - FULL HEIGHT - LICENCE

- Laminate / Stratifié
- Handle / Poignée

Included/Inclus
Included/Inclus

File Drawer - Open Shelf / Tiroirs classeur + étagère ouverte

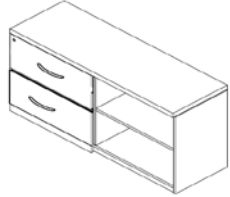

GoCUID / CIUGdC*	Price / Prix	D/P	W/L	H	WT LB	CU
1bCFHLX20L42XOSFFXS*	\$ 934.70	20	42	29	325	12.00
1bCFHLX20L48XOSFFXS*	\$ 974.35	20	48	29	355	18.00
1bCFHLX20L60XOSFFXS*	\$ 1,284.40	20	60	29	385	24.00
1bCFHLX20L72XOSFFXS*	\$ 1,231.75	20	72	29	418	30.00
1bCFHLX24L42XOSFFXS*	\$ 962.00	24	42	29	325	12.00
1bCFHLX24L48XOSFFXS*	\$ 1,003.60	24	48	29	355	18.00
1bCFHLX24L60XOSFFXS*	\$ 1,189.50	24	60	29	385	24.00
1bCFHLX24L72XOSFFXS*	\$ 1,280.50	24	72	29	418	30.00
1bCFHLX20L42XOSFFXK*	\$ 1,142.70	20	42	29	325	12.00
1bCFHLX20L48XOSFFXK*	\$ 1,078.35	20	48	29	355	18.00
1bCFHLX20L60XOSFFXK*	\$ 1,388.40	20	60	29	385	24.00
1bCFHLX20L72XOSFFXK*	\$ 1,335.75	20	72	29	418	30.00
1bCFHLX24L42XOSFFXK*	\$ 1,066.00	24	42	29	325	12.00
1bCFHLX24L48XOSFFXK*	\$ 1,107.60	24	48	29	355	18.00
1bCFHLX24L60XOSFFXK*	\$ 1,293.50	24	60	29	385	24.00
1bCFHLX24L72XOSFFXK*	\$ 1,384.50	24	72	29	418	30.00

Key / Cle

Electronic / Electronique

Open Shelf - File Drawer / Étagère ouverte + tiroirs classeur

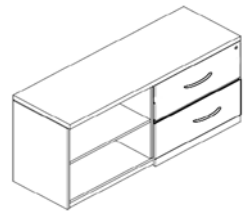

GoCUID / CIUGdC*	Price / Prix	D/P	W/L	H	WT LB	CU
1bCFHLX20L42XFFOSXS*	\$ 934.70	20	42	29	325	12.00
1bCFHLX20L48XFFOSXS*	\$ 974.35	20	48	29	355	18.00
1bCFHLX20L60XFFOSXS*	\$ 1,284.40	20	60	29	385	24.00
1bCFHLX20L72XFFOSXS*	\$ 1,231.75	20	72	29	418	30.00
1bCFHLX24L42XFFOSXS*	\$ 962.00	24	42	29	325	12.00
1bCFHLX24L48XFFOSXS*	\$ 1,003.60	24	48	29	355	18.00
1bCFHLX24L60XFFOSXS*	\$ 1,189.50	24	60	29	385	24.00
1bCFHLX24L72XFFOSXS*	\$ 1,280.50	24	72	29	418	30.00
1bCFHLX20L42XFFOSXK*	\$ 1,142.70	20	42	29	325	12.00
1bCFHLX20L48XFFOSXK*	\$ 1,078.35	20	48	29	355	18.00
1bCFHLX20L60XFFOSXK*	\$ 1,388.40	20	60	29	385	24.00
1bCFHLX20L72XFFOSXK*	\$ 1,335.75	20	72	29	418	30.00
1bCFHLX24L42XFFOSXK*	\$ 1,066.00	24	42	29	325	12.00
1bCFHLX24L48XFFOSXK*	\$ 1,107.60	24	48	29	355	18.00
1bCFHLX24L60XFFOSXK*	\$ 1,293.50	24	60	29	385	24.00
1bCFHLX24L72XFFOSXK*	\$ 1,384.50	24	72	29	418	30.00

Key / Cle

Electronic / Electronique

REQUIRED SPECIFICATIONS / SPÉCIFICATIONS REQUISES

Grand & Toy

E60PQ-140003/045/PQ

CATEGORY 1B - CREDENZAS - FULL HEIGHT - LICENCE

- Laminate / Stratifié
- Handle / Poignée

Included/Inclus
Included/Inclus

File Drawer / Tiroirs classeur

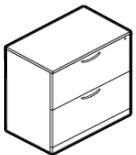
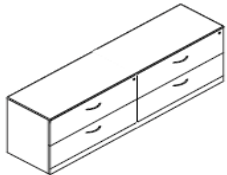

GoCUID / CIUGdC*	Price / Prix	D/P	W/L	H	WT LB	CU
1bCFHLX20L42XFFFFXS	\$ 752.70	20	42	29	325	12.00
1bCFHLX20L48XFFFFXS*	\$ 1,121.25	20	48	29	355	18.00
1bCFHLX20L60XFFFFXS	\$ 1,284.40	20	60	29	385	24.00
1bCFHLX20L72XFFFFXS	\$ 1,380.60	20	72	29	418	30.00
1bCFHLX24L42XFFFFXS	\$ 782.60	24	42	29	325	12.00
1bCFHLX24L48XFFFFXS*	\$ 1,155.70	24	48	29	355	18.00
1bCFHLX24L60XFFFFXS	\$ 1,335.75	24	60	29	385	24.00
1bCFHLX24L72XFFFFXS	\$ 1,435.85	24	72	29	418	30.00
1bCFHLX20L42XFFFFXK	\$ 856.70	20	42	29	325	12.00
1bCFHLX20L48XFFFFXK*	\$ 1,329.25	20	48	29	355	18.00
1bCFHLX20L60XFFFFXK	\$ 1,492.40	20	60	29	385	24.00
1bCFHLX20L72XFFFFXK	\$ 1,588.60	20	72	29	418	30.00
1bCFHLX24L42XFFFFXK	\$ 886.60	24	42	29	325	12.00
1bCFHLX24L48XFFFFXK*	\$ 1,363.70	24	48	29	355	18.00
1bCFHLX24L60XFFFFXK	\$ 1,543.75	24	60	29	385	24.00
1bCFHLX24L72XFFFFXK	\$ 1,643.85	24	72	29	418	30.00

Key / Cle

Electronic / Electronique

File Drawer -Door / Tiroirs classeur + portes

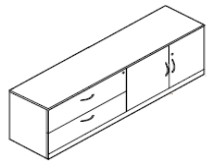

GoCUID / CIUGdC*	Price / Prix	D/P	W/L	H	WT LB	CU
1bCFHLX20L42XDFFXS*	\$ 934.70	20	42	29	297	12.00
1bCFHLX20L48XDFFXS*	\$ 974.35	20	48	29	330	18.00
1bCFHLX20L60XDFFXS	\$ 1,144.00	20	60	29	363	24.00
1bCFHLX20L72XDFFXS	\$ 1,231.75	20	72	29	396	30.00
1bCFHLX24L42XDFFXS*	\$ 962.00	24	42	29	297	12.00
1bCFHLX24L48XDFFXS*	\$ 1,144.00	24	48	29	330	18.00
1bCFHLX24L60XDFFXS	\$ 1,189.50	24	60	29	363	24.00
1bCFHLX24L72XDFFXS	\$ 1,280.50	24	72	29	396	30.00
1bCFHLX20L42XDFFXK*	\$ 1,142.70	20	42	29	297	12.00
1bCFHLX20L48XDFFXK*	\$ 1,182.35	20	48	29	330	18.00
1bCFHLX20L60XDFFXK	\$ 1,352.00	20	60	29	363	24.00
1bCFHLX20L72XDFFXK	\$ 1,439.75	20	72	29	396	30.00
1bCFHLX24L42XDFFXK*	\$ 1,170.00	24	42	29	297	12.00
1bCFHLX24L48XDFFXK*	\$ 1,352.00	24	48	29	330	18.00
1bCFHLX24L60XDFFXK	\$ 1,397.50	24	60	29	363	24.00
1bCFHLX24L72XDFFXK	\$ 1,488.50	24	72	29	396	30.00

Key / Cle

Electronic / Electronique

REQUIRED SPECIFICATIONS / SPÉCIFICATIONS REQUISES

- Laminate / Stratifié
 - Handle / Poignée
- Included/Inclus
Included/Inclus

Door - File Drawer / Portes + tiroirs classeur

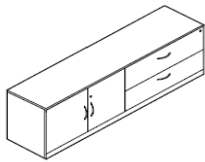

GoCUID / CIUGdC*	Price / Prix	D/P	W/L	H	WT LB	CU
1bCFHLX20L42XFDDXS*	\$ 934.70	20	42	29	297	12.00
1bCFHLX20L48XFDDXS*	\$ 974.35	20	48	29	330	18.00
1bCFHLX20L60XFDDXS	\$ 1,144.00	20	60	29	363	24.00
1bCFHLX20L72XFDDXS	\$ 1,231.75	20	72	29	396	30.00
1bCFHLX24L42XFDDXS*	\$ 962.00	24	42	29	297	12.00
1bCFHLX24L48XFDDXS*	\$ 1,144.00	24	48	29	330	18.00
1bCFHLX24L60XFDDXS	\$ 1,189.50	24	60	29	363	24.00
1bCFHLX24L72XFDDXS	\$ 1,280.50	24	72	29	396	30.00
1bCFHLX20L42XFDDXK*	\$ 1,142.70	20	42	29	297	12.00
1bCFHLX20L48XFDDXK*	\$ 1,182.35	20	48	29	330	18.00
1bCFHLX20L60XFDDXK	\$ 1,352.00	20	60	29	363	24.00
1bCFHLX20L72XFDDXK	\$ 1,439.75	20	72	29	396	30.00
1bCFHLX24L42XFDDXK*	\$ 1,170.00	24	42	29	297	12.00
1bCFHLX24L48XFDDXK*	\$ 1,352.00	24	48	29	330	18.00
1bCFHLX24L60XFDDXK	\$ 1,397.50	24	60	29	363	24.00
1bCFHLX24L72XFDDXK	\$ 1,488.50	24	72	29	396	30.00

Key / Clé

Electronic / Électronique

File Drawer -Box/File Drawer / Tiroirs classeur + tiroirs utilité/tiroir classeur



GoCUID / CIUGdC*	Price / Prix	D/P	W/L	H	WT LB	CU
1bCFHLX20L42XBFFXS*	\$ 1,085.50	20	42	29	297	12.00
1bCFHLX20L48XBFFXS*	\$ 1,164.15	20	48	29	330	18.00
1bCFHLX20L60XBFFXS*	\$ 1,541.15	20	60	29	363	24.00
1bCFHLX20L72XBFFXS*	\$ 1,656.85	20	72	29	396	30.00
1bCFHLX24L42XBFFXS*	\$ 939.25	24	42	29	297	12.00
1bCFHLX24L48XBFFXS*	\$ 1,602.90	24	48	29	330	18.00
1bCFHLX24L60XBFFXS*	\$ 1,602.90	24	60	29	363	24.00
1bCFHLX24L72XBFFXS*	\$ 1,723.15	24	72	29	396	30.00
1bCFHLX20L42XBFFXK*	\$ 1,293.50	20	42	29	297	12.00
1bCFHLX20L48XBFFXK*	\$ 1,372.15	20	48	29	330	18.00
1bCFHLX20L60XBFFXK*	\$ 1,749.15	20	60	29	363	24.00
1bCFHLX20L72XBFFXK*	\$ 1,864.85	20	72	29	396	30.00
1bCFHLX24L42XBFFXK*	\$ 1,043.25	24	42	29	297	12.00
1bCFHLX24L48XBFFXK*	\$ 1,810.90	24	48	29	330	18.00
1bCFHLX24L60XBFFXK*	\$ 1,810.90	24	60	29	363	24.00
1bCFHLX24L72XBFFXK*	\$ 1,931.15	24	72	29	396	30.00

Key / Clé

Electronic / Électronique

REQUIRED SPECIFICATIONS / SPÉCIFICATIONS REQUISES

- Laminate / Stratifié Included/Inclus
- Handle / Poignée Included/Inclus

Box/File Drawer - File Drawer / Tiroirs utilité/tiroir classeur + tiroirs classeur

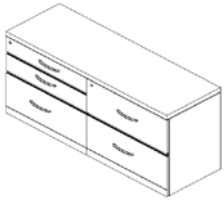

GoCUID / CIUGdC*	Price / Prix	D/P	W/L	H	WT LB	CU
1bCFHLX20L42XFFBFXS*	\$ 1,085.50	20	42	29	297	12.00
1bCFHLX20L48XFFBFXS*	\$ 1,164.15	20	48	29	330	18.00
1bCFHLX20L60XFFBFXS*	\$ 1,541.15	20	60	29	363	24.00
1bCFHLX20L72XFFBFXS*	\$ 1,656.85	20	72	29	396	30.00
1bCFHLX24L42XFFBFXS*	\$ 939.25	24	42	29	297	12.00
1bCFHLX24L48XFFBFXS*	\$ 1,602.90	24	48	29	330	18.00
1bCFHLX24L60XFFBFXS*	\$ 1,602.90	24	60	29	363	24.00
1bCFHLX24L72XFFBFXS*	\$ 1,723.15	24	72	29	396	30.00
1bCFHLX20L42XFFBFXK*	\$ 1,293.50	20	42	29	297	12.00
1bCFHLX20L48XFFBFXK*	\$ 1,372.15	20	48	29	330	18.00
1bCFHLX20L60XFFBFXK*	\$ 1,749.15	20	60	29	363	24.00
1bCFHLX20L72XFFBFXK*	\$ 1,864.85	20	72	29	396	30.00
1bCFHLX24L42XFFBFXK*	\$ 1,043.25	24	42	29	297	12.00
1bCFHLX24L48XFFBFXK*	\$ 1,810.90	24	48	29	330	18.00
1bCFHLX24L60XFFBFXK*	\$ 1,810.90	24	60	29	363	24.00
1bCFHLX24L72XFFBFXK*	\$ 1,931.15	24	72	29	396	30.00

Key / Clé

Electronic / Electronique

Door - Box/File Drawer / Portes + tiroirs utilité/tiroir classeur

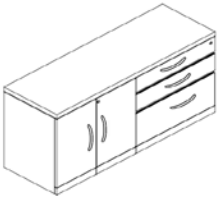

GoCUID / CIUGdC*	Price / Prix	D/P	W/L	H	WT LB	CU
1bCFHLX20L42XBFDXKS*	\$ 977.60	20	42	29	297	12.00
1bCFHLX20L48XBFDXKS*	\$ 1,017.25	20	48	29	330	18.00
1bCFHLX20L60XBFDXKS*	\$ 1,372.80	20	60	29	363	24.00
1bCFHLX20L72XBFDXKS*	\$ 1,478.10	20	72	29	396	30.00
1bCFHLX24L42XBFDXKS*	\$ 1,154.40	24	42	29	297	12.00
1bCFHLX24L48XBFDXKS*	\$ 1,372.80	24	48	29	330	18.00
1bCFHLX24L60XBFDXKS*	\$ 1,427.40	24	60	29	363	24.00
1bCFHLX24L72XBFDXKS*	\$ 1,536.60	24	72	29	396	30.00
1bCFHLX20L42XBFDXKX*	\$ 1,185.60	20	42	29	297	12.00
1bCFHLX20L48XBFDXKX*	\$ 1,225.25	20	48	29	330	18.00
1bCFHLX20L60XBFDXKX*	\$ 1,580.80	20	60	29	363	24.00
1bCFHLX20L72XBFDXKX*	\$ 1,582.10	20	72	29	396	30.00
1bCFHLX24L42XBFDXKX*	\$ 1,362.40	24	42	29	297	12.00
1bCFHLX24L48XBFDXKX*	\$ 1,476.80	24	48	29	330	18.00
1bCFHLX24L60XBFDXKX*	\$ 1,635.40	24	60	29	363	24.00

Key / Clé

Electronic / Electronique

Grand & Toy

E60PQ-140003/045/PQ

CATEGORY 1B - CREDENZAS - FULL HEIGHT - LICENCE

1bCFHLX24L72XBFDXK*	\$ 1,744.60	24	72	29	396	30.00
---------------------	-------------	----	----	----	-----	-------

REQUIRED SPECIFICATIONS / SPÉCIFICATIONS REQUISES

- Laminate / Stratifié Included/Inclus
- Handle / Poignée Included/Inclus

Box/File Drawer - Door / Tiroirs utilité/tiroir classeur + portes

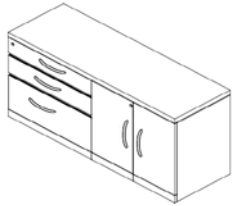

GoCUID / CIUGdC*	Price / Prix	D/P	W/L	H	WT LB	CU
1bCFHLX20L42XDDBFXS*	\$ 977.60	20	42	29	297	12.00
1bCFHLX20L48XDDBFXS*	\$ 1,017.25	20	48	29	330	18.00
1bCFHLX20L60XDDBFXS*	\$ 1,372.80	20	60	29	363	24.00
1bCFHLX20L72XDDBFXS*	\$ 1,478.10	20	72	29	396	30.00
1bCFHLX24L42XDDBFXS*	\$ 1,154.40	24	42	29	297	12.00
1bCFHLX24L48XDDBFXS*	\$ 1,372.80	24	48	29	330	18.00
1bCFHLX24L60XDDBFXS*	\$ 1,427.40	24	60	29	363	24.00
1bCFHLX24L72XDDBFXS*	\$ 1,536.60	24	72	29	396	30.00
1bCFHLX20L42XDDBFXK*	\$ 977.60	20	42	29	297	12.00
1bCFHLX20L48XDDBFXK*	\$ 1,017.25	20	48	29	330	18.00
1bCFHLX20L60XDDBFXK*	\$ 1,372.80	20	60	29	363	24.00
1bCFHLX20L72XDDBFXK*	\$ 1,478.10	20	72	29	396	30.00
1bCFHLX24L42XDDBFXS*	\$ 1,154.40	24	42	29	297	12.00
1bCFHLX24L48XDDBFXS*	\$ 1,372.80	24	48	29	330	18.00
1bCFHLX24L60XDDBFXS*	\$ 1,427.40	24	60	29	363	24.00
1bCFHLX24L72XDDBFXS*	\$ 1,536.60	24	72	29	396	30.00

Key / Clé

Electronic / Electronique

REQUIRED SPECIFICATIONS / SPÉCIFICATIONS REQUISES

- Laminate / Stratifié Included/Inclus
- Handle / Poignée Included/Inclus

Grand & Toy

E60PQ-140003/045/PQ

CATEGORY 1B - CREDENZAS - FULL HEIGHT - LICENCE

APPLICATION NOTES / INSTRUCTIONS D'APPLICATION

- Partial height units herein can be used with Licence floating tops and spacers only.
- May be used with a cushion to provide extra seating
- Units are handed, please select left or right configurations as required
- Configurations shown are for reference only and may differ based on size
- Option for Keyed or E-Lock, please see product descriptions
- **Items marked with a " * " are an extended lead time of 6 weeks**

- Les modules à hauteur partielle peuvent être utilisés avec les surfaces chevauchantes et espaceurs Licence.
- Peut être utilisé avec un coussin pour un siège supplémentaire
- Les modules ne sont pas réversibles, sélectionner une configuration gauche ou droite, selon vos besoins
- Les configurations présentées sont à titre de référence seulement et peuvent différer en fonction de la taille
- Option serrure à clé ou électronique, voir les descriptions de produits

-Les articles marqués d'un " * " ont un délai de production de 6 semaines

- Option serrure à clé ou électronique, voir les descriptions de produits

* Please note the GoCUID used for this product is also applicable for other product combinations. The price shown is specific to the combination of components therein and may be shown below Ceiling Price.

* Veuillez noter que le GoCUID utilisé pour ce produit est également applicable à d'autres combinaisons de produits. Le prix indiqué est spécifique à la combinaison des composants et peut être inférieur au prix plafond

SAMPLE APPLICATION / EXEMPLE D'APPLICATION

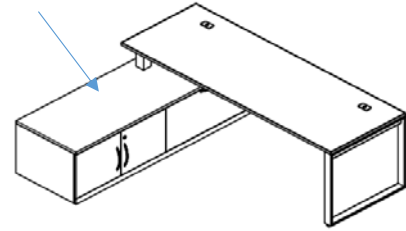

Credenza - Partial Height - Laminate

Crédence - Hauteur partielle - Stratifié - Serrure à clé

Open Shelf / Étagère ouverte

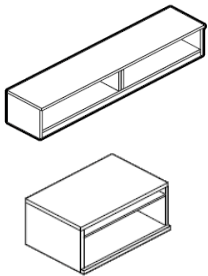

GoCUID / CIUGdC*	Price / Prix	D/P	W/L	H	WT LB	CU
1bCHHLX20L42XOSOSX*	\$ 639.60	20	42	21	147	16.00
1bCHHLX20L48XOSOSX*	\$ 737.10	20	48	21	158	18.00
1bCHHLX20L60XOSOSX*	\$ 737.10	20	60	21	169	22.00
1bCHHLX20L72XOSOSX*	\$ 812.50	20	72	21	180	26.00
1bCHHLX24L42XOSOSX*	\$ 767.00	24	42	21	147	16.00
1bCHHLX24L48XOSOSX*	\$ 767.00	24	48	21	158	18.00
1bCHHLX24L60XOSOSX*	\$ 767.00	24	60	21	169	22.00
1bCHHLX24L72XOSOSX*	\$ 844.35	24	72	21	180	26.00

REQUIRED SPECIFICATIONS / SPÉCIFICATIONS REQUISES

- Laminate / Stratifié
- Included/Inclus

Door - Open Shelf / Portes + étagère ouverte

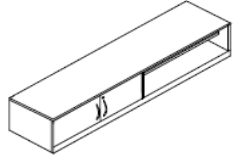

GoCUID / CIUGdC*	Price / Prix	D/P	W/L	H	WT LB	CU
1bCHHLX20L42XOSDDXS*	\$ 737.10	20	42	21	137	16.00
1bCHHLX20L48XOSDDXS*	\$ 737.10	20	48	21	147	18.00
1bCHHLX20L60XOSDDXS	\$ 737.10	20	60	21	169	22.00
1bCHHLX20L72XOSDDXS	\$ 812.50	20	72	21	191	26.00
1bCHHLX24L42XOSDDXS*	\$ 767.00	24	42	21	137	16.00
1bCHHLX24L48XOSDDXS*	\$ 767.00	24	48	21	147	18.00
1bCHHLX24L60XOSDDXS	\$ 767.00	24	60	21	169	22.00
1bCHHLX24L72XOSDDXS	\$ 844.35	24	72	21	191	26.00

Key / Clé



1bCHHLX20L42XOSDDXK*	\$ 841.10	20	42	21	137	16.00
1bCHHLX20L48XOSDDXK*	\$ 841.10	20	48	21	147	18.00
1bCHHLX20L60XOSDDXK	\$ 841.10	20	60	21	169	22.00
1bCHHLX20L72XOSDDXK	\$ 916.50	20	72	21	191	26.00
1bCHHLX24L42XOSDDXK*	\$ 871.00	24	42	21	137	16.00
1bCHHLX24L48XOSDDXK*	\$ 871.00	24	48	21	147	18.00
1bCHHLX24L60XOSDDXK	\$ 871.00	24	60	21	169	22.00
1bCHHLX24L72XOSDDXK	\$ 948.35	24	72	21	191	26.00

Electronic / Électronique

Open Shelf - Door / Étagère ouverte + portes

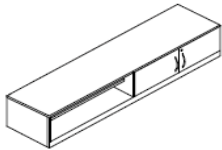

GoCUID / CIUGdC*	Price / Prix	D/P	W/L	H	WT LB	CU
1bCHHLX20L42XDDOSXS*	\$ 737.10	20	42	21	137	18.00
1bCHHLX20L48XDDOSXS*	\$ 737.10	20	48	21	147	20.00
1bCHHLX20L60XDDOSXS	\$ 737.10	20	60	21	169	24.00
1bCHHLX20L72XDDOSXS	\$ 812.50	20	72	21	191	26.00
1bCHHLX24L42XDDOSXS*	\$ 767.00	24	42	21	137	18.00
1bCHHLX24L48XDDOSXS*	\$ 767.00	24	48	21	147	20.00
1bCHHLX24L60XDDOSXS	\$ 767.00	24	60	21	169	24.00
1bCHHLX24L72XDDOSXS	\$ 844.35	24	72	21	191	26.00

Key / Clé



1bCHHLX20L42XDDOSXK*	\$ 841.10	20	42	21	137	18.00
1bCHHLX20L48XDDOSXK*	\$ 841.10	20	48	21	147	20.00
1bCHHLX20L60XDDOSXK	\$ 841.10	20	60	21	169	24.00
1bCHHLX20L72XDDOSXK	\$ 916.50	20	72	21	191	26.00
1bCHHLX24L42XDDOSXK*	\$ 871.00	24	42	21	137	18.00
1bCHHLX24L48XDDOSXK*	\$ 871.00	24	48	21	147	20.00
1bCHHLX24L60XDDOSXK	\$ 871.00	24	60	21	169	24.00
1bCHHLX24L72XDDOSXK	\$ 948.35	24	72	21	191	26.00

Electronic / Électronique

REQUIRED SPECIFICATIONS / SPÉCIFICATIONS REQUISES

- Laminate / Stratifié
 - Handle / Poignée
- Included/Inclus
Included/Inclus

Door / Portes

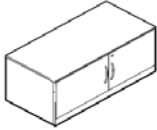
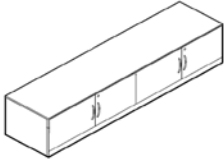

		D/P	W/L	H	WT LB	CU
1bCHHLX20L42XDDDDXS*	\$ 1,005.55	20	42	21	168	16.00
1bCHHLX20L48XDDDDXS*	\$ 1,005.55	20	48	21	178	18.00
1bCHHLX20L60XDDDDXS*	\$ 1,005.55	20	60	21	199	22.00
1bCHHLX20L72XDDDDXS*	\$ 1,085.50	20	72	21	220	26.00
1bCHHLX24L42XDDDDXS*	\$ 1,046.50	24	42	21	168	16.00
1bCHHLX24L48XDDDDXS*	\$ 1,046.50	24	48	21	178	18.00
1bCHHLX24L60XDDDDXS*	\$ 1,046.50	24	60	21	199	22.00
1bCHHLX24L72XDDDDXS*	\$ 1,129.05	24	72	21	220	26.00
1bCHHLX20L42XDDDDXK*	\$ 1,109.55	20	42	21	168	16.00
1bCHHLX20L48XDDDDXK*	\$ 1,213.55	20	48	21	178	18.00
1bCHHLX20L60XDDDDXK*	\$ 1,213.55	20	60	21	199	22.00
1bCHHLX20L72XDDDDXK*	\$ 1,293.50	20	72	21	220	26.00
1bCHHLX24L42XDDDDXK*	\$ 1,254.50	24	42	21	168	16.00
1bCHHLX24L48XDDDDXK*	\$ 1,254.50	24	48	21	178	18.00
1bCHHLX24L60XDDDDXK*	\$ 1,254.50	24	60	21	199	22.00
1bCHHLX24L72XDDDDXK*	\$ 1,337.05	24	72	21	220	26.00

Key / Cle

Electronic / Electronique

Box/File Drawer - Open Shelf / Tiroir utilité/tiroir classeur + étagère ouverte

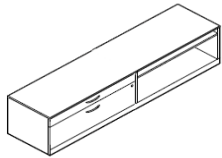

GoCUID / CIUGdC*	Price / Prix	D/P	W/L	H	WT LB	CU
1bCHHLX20L42XOSBFXS*	\$ 1,077.70	20	42	21	124	14.00
1bCHHLX20L48XOSBFXS*	\$ 865.15	20	48	21	150	16.00
1bCHHLX20L60XOSBFXS	\$ 865.15	20	60	21	202	20.00
1bCHHLX20L72XOSBFXS	\$ 961.35	20	72	21	254	24.00
1bCHHLX24L42XOSBFXS*	\$ 900.25	24	42	21	124	14.00
1bCHHLX24L48XOSBFXS*	\$ 900.25	24	48	21	150	16.00
1bCHHLX24L60XOSBFXS	\$ 900.25	24	60	21	202	20.00
1bCHHLX24L72XOSBFXS	\$ 1,000.35	24	72	21	254	24.00
1bCHHLX20L42XOSBFXK*	\$ 1,181.70	20	42	21	124	14.00
1bCHHLX20L48XOSBFXK*	\$ 969.15	20	48	21	150	16.00
1bCHHLX20L60XOSBFXK	\$ 969.15	20	60	21	202	20.00
1bCHHLX20L72XOSBFXK	\$ 1,065.35	20	72	21	254	24.00
1bCHHLX24L42XOSBFXK*	\$ 1,004.25	24	42	21	124	14.00
1bCHHLX24L48XOSBFXK*	\$ 1,004.25	24	48	21	150	16.00
1bCHHLX24L60XOSBFXK	\$ 1,004.25	24	60	21	202	20.00
1bCHHLX24L72XOSBFXK	\$ 1,104.35	24	72	21	254	24.00

Key / Cle

Electronic / Electronique

REQUIRED SPECIFICATIONS / SPÉCIFICATIONS REQUISES

- Laminate / Stratifié

Included/Inclus

Grand & Toy

E60PQ-140003/045/PQ

CATEGORY 1B - CREDENZAS - PARTIAL HEIGHT - LICENCE

- Handle / Poignée

Included/Inclus

Open Shelf - Box/File Drawer / Étagère ouverte + tiroir utilisé/tiroir classeur

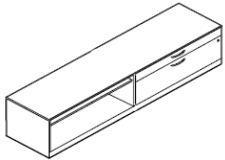

GoCUID / CIUGdC*	Price / Prix	D/P	W/L	H	WT LB	CU
1bCHHLX20L42XBFOXS*	\$ 1,077.70	20	42	21	124	14.00
1bCHHLX20L48XBFOXS*	\$ 865.15	20	48	21	150	16.00
1bCHHLX20L60XBFOXS	\$ 865.15	20	60	21	202	20.00
1bCHHLX20L72XBFOXS	\$ 961.35	20	72	21	254	24.00
1bCHHLX24L42XBFOXS*	\$ 900.25	24	42	21	124	14.00
1bCHHLX24L48XBFOXS*	\$ 900.25	24	48	21	150	16.00
1bCHHLX24L60XBFOXS	\$ 900.25	24	60	21	202	20.00
1bCHHLX24L72XBFOXS	\$ 1,000.35	24	72	21	254	24.00
1bCHHLX20L42XBFOXK*	\$ 1,181.70	20	42	21	124	14.00
1bCHHLX20L48XBFOXK*	\$ 969.15	20	48	21	150	16.00
1bCHHLX20L60XBFOXK	\$ 969.15	20	60	21	202	20.00
1bCHHLX20L72XBFOXK	\$ 1,065.35	20	72	21	254	24.00
1bCHHLX24L42XBFOXK*	\$ 1,004.25	24	42	21	124	14.00
1bCHHLX24L48XBFOXK*	\$ 1,004.25	24	48	21	150	16.00
1bCHHLX24L60XBFOXK	\$ 1,004.25	24	60	21	202	20.00
1bCHHLX24L72XBFOXK	\$ 1,104.35	24	72	21	254	24.00

Key / Cle

Electronic / Electronique

Box/File Drawer / Tiroirs utilisé/tiroirs classeur

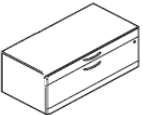
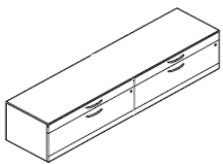

GoCUID / CIUGdC*	Price / Prix	D/P	W/L	H	WT LB	CU
1bCHHLX20L42XBFBFXS*	\$ 1,077.70	20	42	21	187	14.00
1bCHHLX20L48XBFBFXS*	\$ 1,077.70	20	48	21	197	16.00
1bCHHLX20L60XBFBFXS	\$ 1,077.70	20	60	21	218	20.00
1bCHHLX20L72XBFBFXS	\$ 1,145.30	20	72	21	239	24.00
1bCHHLX24L42XBFBFXS*	\$ 1,110.85	24	42	21	187	14.00
1bCHHLX24L48XBFBFXS*	\$ 1,110.85	24	48	21	197	16.00
1bCHHLX24L60XBFBFXS	\$ 1,110.85	24	60	21	218	20.00
1bCHHLX24L72XBFBFXS	\$ 1,179.75	24	72	21	239	24.00
1bCHHLX20L42XBFBFXK*	\$ 1,181.70	20	42	21	187	14.00
1bCHHLX20L48XBFBFXK*	\$ 1,285.70	20	48	21	197	16.00
1bCHHLX20L60XBFBFXK	\$ 1,285.70	20	60	21	218	20.00
1bCHHLX20L72XBFBFXK	\$ 1,353.30	20	72	21	239	24.00
1bCHHLX24L42XBFBFXK*	\$ 1,318.85	24	42	21	187	14.00
1bCHHLX24L48XBFBFXK*	\$ 1,318.85	24	48	21	197	16.00
1bCHHLX24L60XBFBFXK	\$ 1,318.85	24	60	21	218	20.00
1bCHHLX24L72XBFBFXK	\$ 1,387.75	24	72	21	239	24.00

Key / Cle

Electronic / Electronique

REQUIRED SPECIFICATIONS / SPÉCIFICATIONS REQUISES

Grand & Toy

E60PQ-140003/045/PQ

CATEGORY 1B - CREDENZAS - PARTIAL HEIGHT - LICENCE

- Laminate / Stratifié
- Handle / Poignée

- Included/Inclus
- Included/Inclus

File Drawer - Open Shelf / Tiroir classeur + étagère ouverte

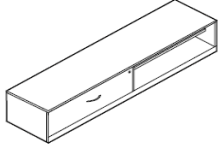

GoCUID / CIUGdC*	Price / Prix	D/P	W/L	H	WT LB	CU
1bCHHLX20L42XOSFFXS*	\$ 734.50	20	42	21	148	16.00
1bCHHLX20L48XOSFFXS*	\$ 734.50	20	48	21	158	18.00
1bCHHLX20L60XOSFFXS	\$ 734.50	20	60	21	179	22.00
1bCHHLX20L72XOSFFXS	\$ 826.15	20	72	21	200	26.00
1bCHHLX24L42XOSFFXS*	\$ 763.75	24	42	21	148	16.00
1bCHHLX24L48XOSFFXS*	\$ 763.75	24	48	21	158	18.00
1bCHHLX24L60XOSFFXS	\$ 763.75	24	60	21	179	22.00
1bCHHLX24L72XOSFFXS	\$ 858.65	24	72	21	200	26.00

Key / Cle



1bCHHLX20L42XOSFFXK*	\$ 838.50	20	42	21	148	16.00
1bCHHLX20L48XOSFFXK*	\$ 838.50	20	48	21	158	18.00
1bCHHLX20L60XOSFFXK	\$ 838.50	20	60	21	179	22.00
1bCHHLX20L72XOSFFXK	\$ 930.15	20	72	21	200	26.00
1bCHHLX24L42XOSFFXK*	\$ 867.75	24	42	21	148	16.00
1bCHHLX24L48XOSFFXK*	\$ 867.75	24	48	21	158	18.00
1bCHHLX24L60XOSFFXK	\$ 867.75	24	60	21	179	22.00
1bCHHLX24L72XOSFFXK	\$ 962.65	24	72	21	200	26.00

Electronic / Electronique

Open Shelf - File Drawer / Étagère ouverte + tiroir classeur

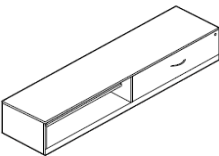

GoCUID / CIUGdC*	Price / Prix	D/P	W/L	H	WT LB	CU
1bCHHLX20L42XFFOSXS*	\$ 734.50	20	42	21	148	16.00
1bCHHLX20L48XFFOSXS*	\$ 734.50	20	48	21	158	18.00
1bCHHLX20L60XFFOSXS	\$ 734.50	20	60	21	179	22.00
1bCHHLX20L72XFFOSXS	\$ 826.15	20	72	21	200	26.00
1bCHHLX24L42XFFOSXS*	\$ 763.75	24	42	21	148	16.00
1bCHHLX24L48XFFOSXS*	\$ 763.75	24	48	21	158	18.00
1bCHHLX24L60XFFOSXS	\$ 763.75	24	60	21	179	22.00
1bCHHLX24L72XFFOSXS	\$ 858.65	24	72	21	200	26.00

Key / Cle



1bCHHLX20L42XFFOSXK*	\$ 838.50	20	42	21	148	16.00
1bCHHLX20L48XFFOSXK*	\$ 838.50	20	48	21	158	18.00
1bCHHLX20L60XFFOSXK	\$ 838.50	20	60	21	179	22.00
1bCHHLX20L72XFFOSXK	\$ 930.15	20	72	21	200	26.00
1bCHHLX24L42XFFOSXK*	\$ 867.75	24	42	21	148	16.00
1bCHHLX24L48XFFOSXK*	\$ 867.75	24	48	21	158	18.00
1bCHHLX24L60XFFOSXK	\$ 867.75	24	60	21	179	22.00
1bCHHLX24L72XFFOSXK	\$ 962.65	24	72	21	200	26.00

Electronic / Electronique

REQUIRED SPECIFICATIONS / SPÉCIFICATIONS REQUISES

Grand & Toy

E60PQ-140003/045/PQ

CATEGORY 1B - CREDENZAS - PARTIAL HEIGHT - LICENCE

- Laminate / Stratifié
- Handle / Poignée

Included/Inclus
Included/Inclus

File Drawer / Tiroirs classeur

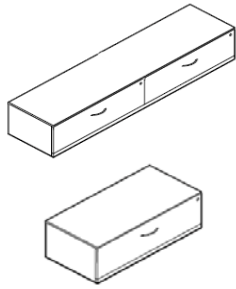

GoCUID / CIUGdC*	Price / Prix	D/P	W/L	H	WT LB	CU
1bCHHLX20L42XFFFFXS	\$ 815.75	20	42	21	133	15.00
1bCHHLX20L48XFFFFXS*	\$ 815.75	20	48	21	160	18.00
1bCHHLX20L60XFFFFXS	\$ 815.75	20	60	21	189	22.00
1bCHHLX20L72XFFFFXS	\$ 872.95	20	72	21	246	26.00
1bCHHLX24L42XFFFFXS	\$ 848.25	24	42	21	133	15.00
1bCHHLX24L48XFFFFXS*	\$ 848.25	24	48	21	160	18.00
1bCHHLX24L60XFFFFXS	\$ 848.25	24	60	21	189	22.00
1bCHHLX24L72XFFFFXS	\$ 908.05	24	72	21	246	26.00

Key / Clé



1bCHHLX20L42XFFFFXK	\$ 919.75	20	42	21	133	15.00
1bCHHLX20L48XFFFFXK*	\$ 1,023.75	20	48	21	160	18.00
1bCHHLX20L60XFFFFXK	\$ 1,023.75	20	60	21	189	22.00
1bCHHLX20L72XFFFFXK	\$ 1,080.95	20	72	21	246	26.00
1bCHHLX24L42XFFFFXK	\$ 1,056.25	24	42	21	133	15.00
1bCHHLX24L48XFFFFXK*	\$ 1,056.25	24	48	21	160	18.00
1bCHHLX24L60XFFFFXK	\$ 1,056.25	24	60	21	189	22.00
1bCHHLX24L72XFFFFXK	\$ 1,116.05	24	72	21	246	26.00

Electronic / Électronique

File Drawer -Door / Tiroir classeur + portes

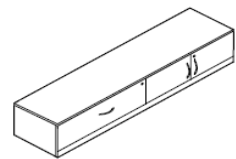

GoCUID / CIUGdC*	Price / Prix	D/P	W/L	H	WT LB	CU
1bCHHLX20L42XDFFXS*	\$ 862.55	20	42	21	168	16.00
1bCHHLX20L48XDFFXS*	\$ 862.55	20	48	21	178	18.00
1bCHHLX20L60XDFFXS	\$ 862.55	20	60	21	199	22.00
1bCHHLX20L72XDFFXS	\$ 969.15	20	72	21	220	26.00
1bCHHLX24L42XDFFXS*	\$ 898.30	24	42	21	168	16.00
1bCHHLX24L48XDFFXS*	\$ 898.30	24	48	21	178	18.00
1bCHHLX24L60XDFFXS	\$ 898.30	24	60	21	199	22.00
1bCHHLX24L72XDFFXS	\$ 1,008.15	24	72	21	220	26.00

Key / Clé



1bCHHLX20L42XDFFXK*	\$ 1,070.55	20	42	21	168	16.00
1bCHHLX20L48XDFFXK*	\$ 1,070.55	20	48	21	178	18.00
1bCHHLX20L60XDFFXK	\$ 1,070.55	20	60	21	199	22.00
1bCHHLX20L72XDFFXK	\$ 1,177.15	20	72	21	220	26.00
1bCHHLX24L42XDFFXK*	\$ 1,106.30	24	42	21	168	16.00
1bCHHLX24L48XDFFXK*	\$ 1,106.30	24	48	21	178	18.00
1bCHHLX24L60XDFFXK	\$ 1,106.30	24	60	21	199	22.00
1bCHHLX24L72XDFFXK	\$ 1,216.15	24	72	21	220	26.00

Electronic / Électronique

Grand & Toy

E60PQ-140003/045/PQ

CATEGORY 1B - CREDENZAS - PARTIAL HEIGHT - LICENCE

REQUIRED SPECIFICATIONS / SPÉCIFICATIONS REQUISES

- Laminate / Stratifié
 - Handle / Poignée
- Included/Inclus
Included/Inclus

Door - File Drawer / Portes + tiroir classeur

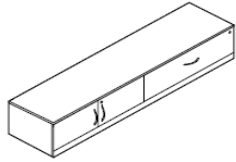

GoCUID / CIUGdC*	Price / Prix	D/P	W/L	H	WT LB	CU
1bCHHLX20L42XFFDDXS*	\$ 862.55	20	42	21	168	16.00
1bCHHLX20L48XFFDDXS*	\$ 862.55	20	48	21	178	18.00
1bCHHLX20L60XFFDDXS	\$ 862.55	20	60	21	199	22.00
1bCHHLX20L72XFFDDXS	\$ 969.15	20	72	21	220	26.00
1bCHHLX24L42XFFDDXS*	\$ 898.30	24	42	21	168	16.00
1bCHHLX24L48XFFDDXS*	\$ 898.30	24	48	21	178	18.00
1bCHHLX24L60XFFDDXS	\$ 898.30	24	60	21	199	22.00
1bCHHLX24L72XFFDDXS	\$ 1,008.15	24	72	21	220	26.00

Key / Clé



1bCHHLX20L42XFFDDXK*	\$ 1,070.55	20	42	21	168	16.00
1bCHHLX20L48XFFDDXK*	\$ 1,070.55	20	48	21	178	18.00
1bCHHLX20L60XFFDDXK	\$ 1,070.55	20	60	21	199	22.00
1bCHHLX20L72XFFDDXK	\$ 1,177.15	20	72	21	220	26.00
1bCHHLX24L42XFFDDXK*	\$ 1,106.30	24	42	21	168	16.00
1bCHHLX24L48XFFDDXK*	\$ 1,106.30	24	48	21	178	18.00
1bCHHLX24L60XFFDDXK	\$ 1,106.30	24	60	21	199	22.00
1bCHHLX24L72XFFDDXK	\$ 1,216.15	24	72	21	220	26.00

Electronic / Électronique

File Drawer -Box/File Drawer / Tiroir classeur + tiroir utilité/tiroir classeur

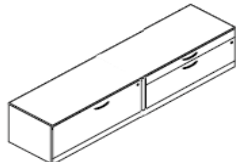

GoCUID / CIUGdC*	Price / Prix	D/P	W/L	H	WT LB	CU
1bCHHLX20L42XBFFFXS*	\$ 978.90	20	42	21	168	16.00
1bCHHLX20L48XBFFFXS*	\$ 1,077.70	20	48	21	178	18.00
1bCHHLX20L60XBFFFXS*	\$ 1,077.70	20	60	21	199	22.00
1bCHHLX20L72XBFFFXS*	\$ 1,145.30	20	72	21	220	26.00
1bCHHLX24L42XBFFFXS*	\$ 1,335.75	24	42	21	168	16.00
1bCHHLX24L48XBFFFXS*	\$ 1,335.75	24	48	21	178	18.00
1bCHHLX24L60XBFFFXS*	\$ 1,110.85	24	60	21	199	22.00
1bCHHLX24L72XBFFFXS*	\$ 1,179.75	24	72	21	220	26.00

Key / Clé



1bCHHLX20L42XBFFFXK*	\$ 1,186.90	20	42	21	168	16.00
1bCHHLX20L48XBFFFXK*	\$ 1,285.70	20	48	21	178	18.00
1bCHHLX20L60XBFFFXK*	\$ 1,285.70	20	60	21	199	22.00
1bCHHLX20L72XBFFFXK*	\$ 1,353.30	20	72	21	220	26.00
1bCHHLX24L42XBFFFXK*	\$ 1,543.75	24	42	21	168	16.00
1bCHHLX24L48XBFFFXK*	\$ 1,543.75	24	48	21	178	18.00
1bCHHLX24L60XBFFFXK*	\$ 1,318.85	24	60	21	199	22.00
1bCHHLX24L72XBFFFXK*	\$ 1,387.75	24	72	21	220	26.00

Electronic / Électronique

REQUIRED SPECIFICATIONS / SPÉCIFICATIONS REQUISES

- Laminate / Stratifié Included/Inclus
- Handle / Poignée Included/Inclus

Box/File Drawer - File Drawer / Tiroir utilité/tiroir classeur + tiroir classeur

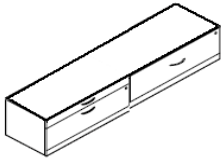

GoCUID / CIUGdC*	Price / Prix	D/P	W/L	H	WT LB	CU
1bCHHLX20L42XFFBFXS*	\$ 978.90	20	42	21	168	16.00
1bCHHLX20L48XFFBFXS*	\$ 1,077.70	20	48	21	178	18.00
1bCHHLX20L60XFFBFXS*	\$ 1,077.70	20	60	21	199	22.00
1bCHHLX20L72XFFBFXS*	\$ 1,145.30	20	72	21	220	26.00
1bCHHLX24L42XFFBFXS*	\$ 1,335.75	24	42	21	168	16.00
1bCHHLX24L48XFFBFXS*	\$ 1,335.75	24	48	21	178	18.00
1bCHHLX24L60XFFBFXS*	\$ 1,110.85	24	60	21	199	22.00
1bCHHLX24L72XFFBFXS*	\$ 1,179.75	24	72	21	220	26.00

Key / Clé



1bCHHLX20L42XFFBFXK*	\$ 1,186.90	20	42	21	168	16.00
1bCHHLX20L48XFFBFXK*	\$ 1,285.70	20	48	21	178	18.00
1bCHHLX20L60XFFBFXK*	\$ 1,285.70	20	60	21	199	22.00
1bCHHLX20L72XFFBFXK*	\$ 1,353.30	20	72	21	220	26.00
1bCHHLX24L42XFFBFXK*	\$ 1,543.75	24	42	21	168	16.00
1bCHHLX24L48XFFBFXK*	\$ 1,543.75	24	48	21	178	18.00
1bCHHLX24L60XFFBFXK*	\$ 1,318.85	24	60	21	199	22.00
1bCHHLX24L72XFFBFXK*	\$ 1,387.75	24	72	21	220	26.00

Electronic / Electronique

Door - Box/File Drawer / Portes + tiroir utilité/tiroir classeur

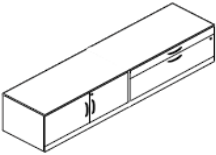

GoCUID / CIUGdC*	Price / Prix	D/P	W/L	H	WT LB	CU
1bCHHLX20L42XBFDDXS*	\$ 993.85	20	42	21	183	16.00
1bCHHLX20L48XBFDDXS*	\$ 993.85	20	48	21	193	18.00
1bCHHLX20L60XBFDDXS	\$ 993.85	20	60	21	214	20.00
1bCHHLX20L72XBFDDXS	\$ 1,105.00	20	72	21	235	24.00
1bCHHLX24L42XBFDDXS*	\$ 1,033.50	24	42	21	183	16.00
1bCHHLX24L48XBFDDXS*	\$ 1,033.50	24	48	21	193	18.00
1bCHHLX24L60XBFDDXS	\$ 1,033.50	24	60	21	214	20.00
1bCHHLX24L72XBFDDXS	\$ 1,149.20	24	72	21	235	24.00

Key / Clé



1bCHHLX20L42XBFDDXK*	\$ 1,201.85	20	42	21	183	16.00
1bCHHLX20L48XBFDDXK*	\$ 1,201.85	20	48	21	193	18.00
1bCHHLX20L60XBFDDXK	\$ 1,201.85	20	60	21	214	20.00
1bCHHLX20L72XBFDDXK	\$ 1,313.00	20	72	21	235	24.00
1bCHHLX24L42XBFDDXK*	\$ 1,241.50	24	42	21	183	16.00
1bCHHLX24L48XBFDDXK*	\$ 1,241.50	24	48	21	193	18.00
1bCHHLX24L60XBFDDXK	\$ 1,241.50	24	60	21	214	20.00

Electronic / Electronique

Grand & Toy

E60PQ-140003/045/PQ

CATEGORY 1B - CREDENZAS - PARTIAL HEIGHT - LICENCE

1bCHHLX24L72XBFDXK	\$ 1,357.20	24	72	21	235	24.00
--------------------	-------------	----	----	----	-----	-------

REQUIRED SPECIFICATIONS / SPÉCIFICATIONS REQUISES

- Laminate / Stratifié Included/Inclus
- Handle / Poignée Included/Inclus

Box/File Drawer - Door / Tiroir utilité/tiroir classeur + portes

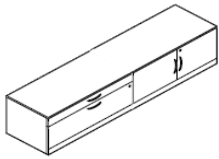

GoCUID / CIUGdC*	Price / Prix	D/P	W/L	H	WT LB	CU
1bCHHLX20L42XDDBFXS*	\$ 993.85	20	42	21	183	16.00
1bCHHLX20L48XDDBFXS*	\$ 993.85	20	48	21	193	18.00
1bCHHLX20L60XDDBFXS	\$ 993.85	20	60	21	214	20.00
1bCHHLX20L72XDDBFXS	\$ 1,105.00	20	72	21	235	24.00
1bCHHLX24L42XDDBFXS*	\$ 1,033.50	24	42	21	183	16.00
1bCHHLX24L48XDDBFXS*	\$ 1,033.50	24	48	21	193	18.00
1bCHHLX24L60XDDBFXS	\$ 1,033.50	24	60	21	214	20.00
1bCHHLX24L72XDDBFXS	\$ 1,149.20	24	72	21	235	24.00

Key / Clé



1bCHHLX20L42XDDBFXK*	\$ 1,201.85	20	42	21	183	16.00
1bCHHLX20L48XDDBFXK*	\$ 1,201.85	20	48	21	193	18.00
1bCHHLX20L60XDDBFXK	\$ 1,201.85	20	60	21	214	20.00
1bCHHLX20L72XDDBFXK	\$ 1,313.00	20	72	21	235	24.00
1bCHHLX24L42XDDBFXK*	\$ 1,241.50	24	42	21	183	16.00
1bCHHLX24L48XDDBFXK*	\$ 1,241.50	24	48	21	193	18.00
1bCHHLX24L60XDDBFXK	\$ 1,241.50	24	60	21	214	20.00
1bCHHLX24L72XDDBFXK	\$ 1,357.20	24	72	21	235	24.00

Electronic / Electronique

REQUIRED SPECIFICATIONS / SPÉCIFICATIONS REQUISES

- Laminate / Stratifié Included/Inclus
- Handle / Poignée Included/Inclus

Grand & Toy

E60PQ-140003/045/PQ

CATEGORY 1B - CREDENZAS - PARTIAL HEIGHT - LICENCE

APPLICATION NOTES / INSTRUCTIONS D'APPLICATION

- Metal storage with laminate top
- When used with a hutch the total height combined can not exceed 66"H
- Co-ordinates with other 1200 series metal storage units
- Will not work with floating tops and spacers, please use Partial Height Credenzas for this application
- Configurations shown are for reference only and may differ based on size
- Option for Keyed or E-Lock, different GoCUID, please see product descriptions
- **All metal credenzas are extended lead time items of 6-8 weeks**

- Rangement en métal avec dessus en stratifié
- Lorsqu'utilisé avec une huche, la hauteur totale combinée ne peut pas dépasser 66 po H
- Se coordonne aux autres modules de rangement en métal de la gamme 1200
- N'est pas compatible pas avec les surfaces chevauchantes et espaceurs, utiliser des crédences à hauteur partielle pour cette application
- Les configurations présentées sont à titre de référence seulement et peuvent différer en fonction de la taille
- Option serrure à clé ou électronique, voir les descriptions de produits
- **Toutes les crédences en métal ont un délai de production de 6-8 semaines**

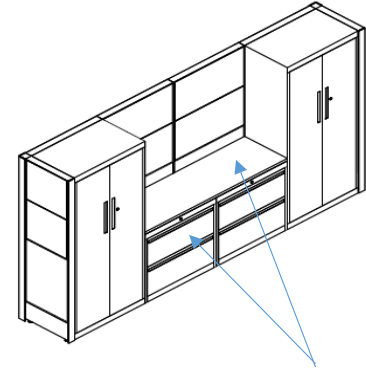

SAMPLE APPLICATION / EXEMPLE D'APPLICATION

* Please note the GoCUID used for this product is also applicable for other product combinations. The price shown is specific to the combination of components therein and may be shown below Ceiling Price.

* Veuillez noter que le GoCUID utilisé pour ce produit est également applicable à d'autres combinaisons de produits. Le prix indiqué est spécifique à la combinaison des composants et peut être inférieur au prix plafond

Credenza - Full Height - Painted Metal

Crédence - Pleine hauteur - Métal peint

Open Shelf / Étagère ouverte

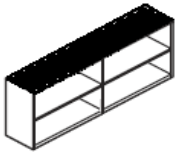

GoCUID / CIUGdC*	Price / Prix	D/P	W/L	H	WT LB	CU
1bCFHAX20L42XOSOSX	\$ 1,757.60	20	42	29	102	15.36
1bCFHAX20L60XOSOSX	\$ 1,390.35	20	60	29	139	22.80
1bCFHAX20L72XOSOSX	\$ 1,457.30	20	72	29	152	26.76
1bCFHAX24L42XOSOSX	\$ 1,834.95	24	42	29	102	15.36
1bCFHAX24L60XOSOSX	\$ 3,433.30	24	60	29	139	22.80
1bCFHAX24L72XOSOSX	\$ 3,525.60	24	72	29	152	26.76

REQUIRED SPECIFICATIONS / SPÉCIFICATIONS REQUISES

- Laminate / Stratifié Included/Inclus
- Metal / Métal Included/Inclus

Door - Open Shelf / Portes + étagère ouverte

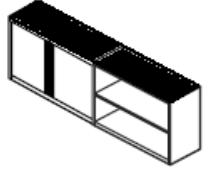

GoCUID / CIUGdC*	Price / Prix	D/P	W/L	H	WT LB	CU
1bCFHAX20L60XOSDDXS	\$ 1,504.75	20	60	29	236	22.80
1bCFHAX20L72XOSDDXS	\$ 1,579.50	20	72	29	269	26.76
1bCFHAX24L60XOSDDXS	\$ 3,435.25	24	60	29	236	22.80
1bCFHAX24L72XOSDDXS	\$ 3,529.50	24	72	29	269	26.76
1bCFHAX20L60XOSDDXK	\$ 1,796.60	20	60	29	236	22.80
1bCFHAX20L72XOSDDXK	\$ 1,871.35	20	72	29	269	26.76
1bCFHAX24L60XOSDDXK	\$ 3,777.80	24	60	29	236	22.80
1bCFHAX24L72XOSDDXK	\$ 3,872.05	24	72	29	269	26.76

Key / Clé

Electronic /
Électronique

Open Shelf - Door / Étagère ouverte + portes

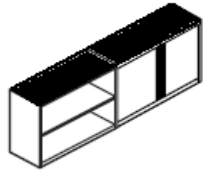

GoCUID / CIUGdC*	Price / Prix	D/P	W/L	H	WT LB	CU
1bCFHAX20L60XDDOSXS	\$ 1,504.75	20	60	29	236	22.80
1bCFHAX20L72XDDOSXS	\$ 1,579.50	20	72	29	269	26.76
1bCFHAX24L60XDDOSXS	\$ 3,435.25	24	60	29	236	22.80
1bCFHAX24L72XDDOSXS	\$ 3,529.50	24	72	29	269	26.76
1bCFHAX20L60XDDOSXK	\$ 1,796.60	20	60	29	236	22.80
1bCFHAX20L72XDDOSXK	\$ 1,871.35	20	72	29	269	26.76
1bCFHAX24L60XDDOSXK	\$ 3,777.80	24	60	29	236	22.80
1bCFHAX24L72XDDOSXK	\$ 3,872.05	24	72	29	269	26.76

Key / Clé

Electronic /
Électronique

REQUIRED SPECIFICATIONS / SPÉCIFICATIONS REQUISES

- Laminate / Stratifié Included/Inclus
- Metal / Métal Included/Inclus

Door / Portes

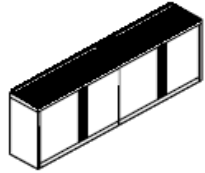

GoCUID / CIUGdC*	Price / Prix	D/P	W/L	H	WT LB	CU
1bCFHLX20L42XDDDDXS	\$ 618.15	20	42	29	311	18.84
1bCFHLX20L60XDDDDXS	\$ 1,005.55	20	60	29	334	22.80
1bCFHLX20L72XDDDDXS	\$ 1,085.50	20	72	29	386	26.76
1bCFHLX24L42XDDDDXS	\$ 642.85	24	42	29	311	18.84
1bCFHLX24L60XDDDDXS	\$ 1,046.50	24	60	29	334	22.80
1bCFHLX24L72XDDDDXS	\$ 1,129.05	24	72	29	386	26.76
1bCFHLX20L42XDDDDXK	\$ 722.15	20	42	29	311	18.84
1bCFHLX20L60XDDDDXK	\$ 1,109.55	20	60	29	334	22.80
1bCFHLX20L72XDDDDXK	\$ 1,293.50	20	72	29	386	26.76
1bCFHLX24L42XDDDDXK	\$ 746.85	24	42	29	311	18.84
1bCFHLX24L60XDDDDXK	\$ 1,254.50	24	60	29	334	22.80
1bCFHLX24L72XDDDDXK	\$ 1,337.05	24	72	29	386	26.76

Key / Clé

Electronic /
Électronique

Box/File Drawer - Open Shelf / Tiroirs utilité/tiroir classeur + étagère ouverte

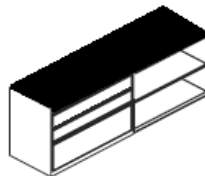

GoCUID / CIUGdC*	Price / Prix	D/P	W/L	H	WT LB	CU
1bCFHAX20L42XOSBFXS	\$ 1,958.45	20	42	29	134	15.36
1bCFHAX20L60XOSBFXS	\$ 2,000.05	20	60	29	173	22.80
1bCFHAX20L72XOSBFXS	\$ 2,100.15	20	72	29	195	26.76
1bCFHAX24L42XOSBFXS	\$ 2,048.80	24	42	29	134	15.36
1bCFHAX24L60XOSBFXS	\$ 3,135.60	24	60	29	173	22.80
1bCFHAX24L72XOSBFXS	\$ 3,257.15	24	72	29	195	26.76
1bCFHAX20L42XOSBFXK	\$ 2,364.70	20	42	29	134	15.36
1bCFHAX20L60XOSBFXK	\$ 2,327.00	20	60	29	173	22.80
1bCFHAX20L72XOSBFXK	\$ 2,425.80	20	72	29	195	26.76
1bCFHAX24L42XOSBFXK	\$ 2,376.40	24	42	29	134	15.36
1bCFHAX24L60XOSBFXK	\$ 3,461.90	24	60	29	173	22.80
1bCFHAX24L72XOSBFXK	\$ 3,585.40	24	72	29	195	26.76

Key / Clé

Electronic /
Électronique

REQUIRED SPECIFICATIONS / SPÉCIFICATIONS REQUISES

- Laminate / Stratifié Included/Inclus
- Metal / Métal Included/Inclus

Open Shelf - Box/File Drawer / Étagère ouverte + tiroirs utilité/tiroir classeur

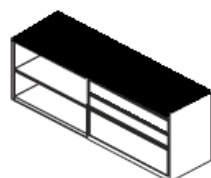

GoCUID / CIUGdC*	Price / Prix	D/P	W/L	H	WT LB	CU
1bCFHAX20L42XBFOXS	\$ 1,958.45	20	42	29	134	15.36
1bCFHAX20L60XBFOXS	\$ 2,000.05	20	60	29	173	22.80
1bCFHAX20L72XBFOXS	\$ 2,100.15	20	72	29	195	26.76
1bCFHAX24L42XBFOXS	\$ 2,048.80	24	42	29	134	15.36
1bCFHAX24L60XBFOXS	\$ 3,135.60	24	60	29	173	22.80
1bCFHAX24L72XBFOXS	\$ 3,257.15	24	72	29	195	26.76
1bCFHAX20L42XBFOXK	\$ 2,364.70	20	42	29	134	15.36
1bCFHAX20L60XBFOXK	\$ 2,327.00	20	60	29	173	22.80
1bCFHAX20L72XBFOXK	\$ 2,425.80	20	72	29	195	26.76
1bCFHAX24L42XBFOXK	\$ 2,376.40	24	42	29	134	15.36
1bCFHAX24L60XBFOXK	\$ 3,461.90	24	60	29	173	22.80
1bCFHAX24L72XBFOXK	\$ 3,585.40	24	72	29	195	26.76

Key / Clé

Electronic /
Électronique



Box/File Drawer / Tiroirs utilité/tiroirs classeur

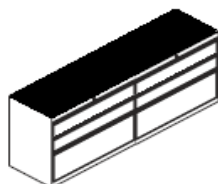

GoCUID / CIUGdC*	Price / Prix	D/P	W/L	H	WT LB	CU
1bCFHAX20L42XBFBFXS	\$ 1,508.00	20	42	29	134	15.36
1bCFHAX20L60XBFBFXS	\$ 2,609.75	20	60	29	207	22.80
1bCFHAX20L72XBFBFXS	\$ 2,743.00	20	72	29	239	26.76
1bCFHAX24L42XBFBFXS	\$ 1,628.90	24	42	29	134	15.36
1bCFHAX24L60XBFBFXS	\$ 2,837.90	24	60	29	207	22.80
1bCFHAX24L72XBFBFXS	\$ 2,988.70	24	72	29	239	26.76
1bCFHAX20L42XBFBFXK	\$ 1,833.65	20	42	29	134	15.36
1bCFHAX20L60XBFBFXK	\$ 3,263.65	20	60	29	207	22.80
1bCFHAX20L72XBFBFXK	\$ 3,394.30	20	72	29	239	26.76
1bCFHAX24L42XBFBFXK	\$ 1,954.55	24	42	29	134	15.36
1bCFHAX24L60XBFBFXK	\$ 3,490.50	24	60	29	207	22.80
1bCFHAX24L72XBFBFXK	\$ 3,645.20	24	72	29	239	26.76

Key / Clé

Electronic /
Électronique



REQUIRED SPECIFICATIONS / SPÉCIFICATIONS REQUISES

- Laminate / Stratifié Included/Inclus
- Metal / Métal Included/Inclus

File Drawer - Open Shelf / Tiroirs classeur + étagère ouverte

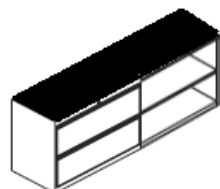

GoCUID / CIUGdC*	Price / Prix	D/P	W/L	H	WT LB	CU
1bCFHAX20L42XOSFFXS	\$ 1,849.25	20	42	29	134	15.36
1bCFHAX20L60XOSFFXS	\$ 1,798.55	20	60	29	173	22.80
1bCFHAX20L72XOSFFXS	\$ 1,892.80	20	72	29	195	26.76
1bCFHAX24L42XOSFFXS	\$ 1,931.15	24	42	29	134	15.36
1bCFHAX24L60XOSFFXS	\$ 2,882.10	24	60	29	173	22.80
1bCFHAX24L72XOSFFXS	\$ 3,033.55	24	72	29	195	26.76
1bCFHAX20L42XOSFFXK	\$ 2,176.20	20	42	29	134	15.36
1bCFHAX20L60XOSFFXK	\$ 2,124.85	20	60	29	173	22.80
1bCFHAX20L72XOSFFXK	\$ 2,220.40	20	72	29	195	26.76
1bCFHAX24L42XOSFFXK	\$ 2,256.15	24	42	29	134	15.36
1bCFHAX24L60XOSFFXK	\$ 3,242.20	24	60	29	173	22.80
1bCFHAX24L72XOSFFXK	\$ 3,359.20	24	72	29	195	26.76

Key / Clé

Electronic /
Électronique

Open Shelf - File Drawer / Étagère ouverte + tiroirs classeur

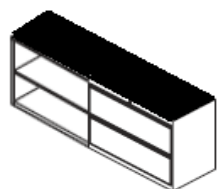

GoCUID / CIUGdC*	Price / Prix	D/P	W/L	H	WT LB	CU
1bCFHAX20L42XFFOSXS	\$ 1,849.25	20	42	29	134	15.36
1bCFHAX20L60XFFOSXS	\$ 1,798.55	20	60	29	173	22.80
1bCFHAX20L72XFFOSXS	\$ 1,892.80	20	72	29	195	26.76
1bCFHAX24L42XFFOSXS	\$ 1,931.15	24	42	29	134	15.36
1bCFHAX24L60XFFOSXS	\$ 2,882.10	24	60	29	173	22.80
1bCFHAX24L72XFFOSXS	\$ 3,033.55	24	72	29	195	26.76
1bCFHAX20L42XFFOSXK	\$ 2,176.20	20	42	29	134	15.36
1bCFHAX20L60XFFOSXK	\$ 2,124.85	20	60	29	173	22.80
1bCFHAX20L72XFFOSXK	\$ 2,220.40	20	72	29	195	26.76
1bCFHAX24L42XFFOSXK	\$ 2,256.15	24	42	29	134	15.36
1bCFHAX24L60XFFOSXK	\$ 3,242.20	24	60	29	173	22.80
1bCFHAX24L72XFFOSXK	\$ 3,359.20	24	72	29	195	26.76

Key / Clé

Electronic /
Électronique

REQUIRED SPECIFICATIONS / SPÉCIFICATIONS REQUISES

- Laminate / Stratifié Included/Inclus
- Metal / Métal Included/Inclus

File Drawer / Tiroirs classeur

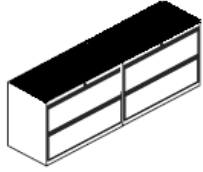

GoCUID / CIUGdC*	Price / Prix	D/P	W/L	H	WT LB	CU
1bCFHAX20L42XFFFFXS	\$ 1,294.15	20	42	29	134	15.36
1bCFHAX20L60XFFFFXS	\$ 1,200.55	20	60	29	207	22.80
1bCFHAX20L72XFFFFXS	\$ 2,328.30	20	72	29	239	26.76
1bCFHAX24L42XFFFFXS	\$ 1,398.15	24	42	29	134	15.36
1bCFHAX24L60XFFFFXS	\$ 2,330.90	24	60	29	207	22.80
1bCFHAX24L72XFFFFXS	\$ 2,541.50	24	72	29	239	26.76
1bCFHAX20L42XFFFFXK	\$ 1,386.45	20	42	29	134	15.36
1bCFHAX20L60XFFFFXK	\$ 1,526.85	20	60	29	207	22.80
1bCFHAX20L72XFFFFXK	\$ 2,983.50	20	72	29	239	26.76
1bCFHAX24L42XFFFFXK	\$ 1,725.10	24	42	29	134	15.36
1bCFHAX24L60XFFFFXK	\$ 3,051.10	24	60	29	207	22.80
1bCFHAX24L72XFFFFXK	\$ 3,192.80	24	72	29	239	26.76

Key / Clé

Electronic /
Électronique

File Drawer -Door / Tiroirs classeur + portes

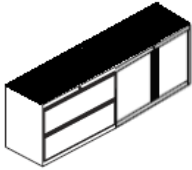

GoCUID / CIUGdC*	Price / Prix	D/P	W/L	H	WT LB	CU
1bCFHAX20L60XDDFFXS	\$ 1,912.95	20	60	29	192	22.80
1bCFHAX20L72XDDFFXS	\$ 1,993.55	20	72	29	219	26.76
1bCFHAX24L60XDDFFXS	\$ 2,884.05	24	60	29	192	22.80
1bCFHAX24L72XDDFFXS	\$ 3,037.45	24	72	29	219	26.76
1bCFHAX20L60XDDFFXK	\$ 2,531.10	20	60	29	192	22.80
1bCFHAX20L72XDDFFXK	\$ 2,306.85	20	72	29	219	26.76
1bCFHAX24L60XDDFFXK	\$ 3,586.70	24	60	29	192	22.80
1bCFHAX24L72XDDFFXK	\$ 3,705.65	24	72	29	219	26.76

Key / Clé

Electronic /
Électronique

REQUIRED SPECIFICATIONS / SPÉCIFICATIONS REQUISES

- Laminate / Stratifié Included/Inclus
- Metal / Métal Included/Inclus

Door - File Drawer / Portes + tiroirs classeur

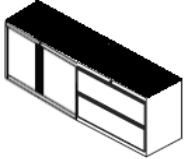

GoCUID / CIUGdC*	Price / Prix	D/P	W/L	H	WT LB	CU
1bCFHAX20L60XFFDDXS	\$ 1,912.95	20	60	29	192	22.80
1bCFHAX20L72XFFDDXS	\$ 1,993.55	20	72	29	219	26.76
1bCFHAX24L60XFFDDXS	\$ 2,884.05	24	60	29	192	22.80
1bCFHAX24L72XFFDDXS	\$ 3,037.45	24	72	29	219	26.76
1bCFHAX20L60XFFDDXK	\$ 2,531.10	20	60	29	192	22.80
1bCFHAX20L72XFFDDXK	\$ 2,306.85	20	72	29	219	26.76
1bCFHAX24L60XFFDDXK	\$ 3,586.70	24	60	29	192	22.80
1bCFHAX24L72XFFDDXK	\$ 3,705.65	24	72	29	219	26.76

Key / Clé

Electronic /
Électronique

File Drawer -Box/File Drawer / Tiroirs classeur + tiroirs utilité/tiroir classeur

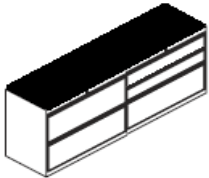

GoCUID / CIUGdC*	Price / Prix	D/P	W/L	H	WT LB	CU
1bCFHAX20L42XBFFFXS	\$ 1,508.00	20	42	29	134	15.36
1bCFHAX20L60XBFFFXS	\$ 2,408.25	20	60	29	207	22.80
1bCFHAX20L72XBFFFXS	\$ 2,535.65	20	72	29	239	26.76
1bCFHAX24L42XBFFFXS	\$ 1,628.90	24	42	29	134	15.36
1bCFHAX24L60XBFFFXS	\$ 2,584.40	24	60	29	207	22.80
1bCFHAX24L72XBFFFXS	\$ 2,765.10	24	72	29	239	26.76
1bCFHAX20L42XBFFFXK	\$ 1,833.65	20	42	29	134	15.36
1bCFHAX20L60XBFFFXK	\$ 3,061.50	20	60	29	207	22.80
1bCFHAX20L72XBFFFXK	\$ 3,188.90	20	72	29	239	26.76
1bCFHAX24L42XBFFFXK	\$ 1,954.55	24	42	29	134	15.36
1bCFHAX24L60XBFFFXK	\$ 3,270.80	24	60	29	207	22.80
1bCFHAX24L72XBFFFXK	\$ 3,419.00	24	72	29	239	26.76

Key / Clé

Electronic /
Électronique

REQUIRED SPECIFICATIONS / SPÉCIFICATIONS REQUISES

- Laminate / Stratifié Included/Inclus
- Metal / Métal Included/Inclus

Box/File Drawer - File Drawer / Tiroirs utilité/tiroir classeur + tiroirs classeur

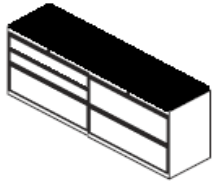

GoCUID / CIUGdC*	Price / Prix	D/P	W/L	H	WT LB	CU
1bCFHAX20L42XFFBFXS	\$ 1,508.00	20	42	29	134	15.36
1bCFHAX20L60XFFBFXS	\$ 2,408.25	20	60	29	207	22.80
1bCFHAX20L72XFFBFXS	\$ 2,535.65	20	72	29	239	26.76
1bCFHAX24L42XFFBFXS	\$ 1,628.90	24	42	29	134	15.36
1bCFHAX24L60XFFBFXS	\$ 2,584.40	24	60	29	207	22.80
1bCFHAX24L72XFFBFXS	\$ 2,765.10	24	72	29	239	26.76
1bCFHAX20L42XFFBFXK	\$ 1,833.65	20	42	29	134	15.36
1bCFHAX20L60XFFBFXK	\$ 3,061.50	20	60	29	207	22.80
1bCFHAX20L72XFFBFXK	\$ 3,188.90	20	72	29	239	26.76
1bCFHAX24L42XFFBFXK	\$ 1,954.55	24	42	29	134	15.36
1bCFHAX24L60XFFBFXK	\$ 3,270.80	24	60	29	207	22.80
1bCFHAX24L72XFFBFXK	\$ 3,419.00	24	72	29	239	26.76

Key / Clé

Electronic /
Électronique

Door - Box/File Drawer / Portes + tiroirs utilité/tiroir classeur

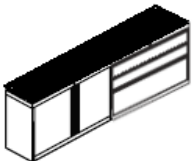

GoCUID / CIUGdC*	Price / Prix	D/P	W/L	H	WT LB	CU
1bCFHAX20L60XBFDDXS	\$ 2,114.45	20	60	29	192	22.80
1bCFHAX20L72XBFDDXS	\$ 2,222.35	20	72	29	219	26.76
1bCFHAX24L60XBFDDXS	\$ 3,137.55	24	60	29	192	22.80
1bCFHAX24L72XBFDDXS	\$ 3,261.05	24	72	29	219	26.76
1bCFHAX20L60XBFDDXK	\$ 2,733.25	20	60	29	192	22.80
1bCFHAX20L72XBFDDXK	\$ 2,839.85	20	72	29	219	26.76
1bCFHAX24L60XBFDDXK	\$ 3,806.40	24	60	29	192	22.80
1bCFHAX24L72XBFDDXK	\$ 3,931.85	24	72	29	219	26.76

Key / Clé

Electronic /
Électronique

REQUIRED SPECIFICATIONS / SPÉCIFICATIONS REQUISES

- Laminate / Stratifié Included/Inclus
- Metal / Métal Included/Inclus

Box/File Drawer - Door / Tiroirs utilité/tiroir classeur + portes

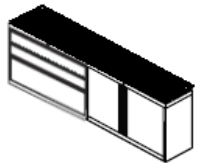

GoCUID / CIUGdC*	Price / Prix	D/P	W/L	H	WT LB	CU
1bCFHAX20L60XDDBFXS	\$ 2,114.45	20	60	29	192	22.80
1bCFHAX20L72XDDBFXS	\$ 2,222.35	20	72	29	219	26.76
1bCFHAX24L60XDDBFXS	\$ 3,137.55	24	60	29	192	22.80
1bCFHAX24L72XDDBFXS	\$ 3,261.05	24	72	29	219	26.76
1bCFHAX20L60XDDBFXK	\$ 2,733.25	20	60	29	192	22.80
1bCFHAX20L72XDDBFXK	\$ 2,839.85	20	72	29	219	26.76
1bCFHAX24L60XDDBFXK	\$ 3,806.40	24	60	29	192	22.80
1bCFHAX24L72XDDBFXK	\$ 3,931.85	24	72	29	219	26.76

Key / Clé

Electronic /
Électronique

REQUIRED SPECIFICATIONS / SPÉCIFICATIONS REQUISES

- Laminate / Stratifié Included/Inclus
- Metal / Métal Included/Inclus

Grand & Toy

E60PQ-140003/045/PQ

CATEGORY 1B - CREDENZAS - FULL HEIGHT - 1200 SERIES

APPLICATION NOTES / INSTRUCTIONS D'APPLICATION

- Metal storage with laminate top
- Units are handed, please select left or right configurations as required
- May be used with floating tops and risers. Intended for use with Licence series.
- Configurations shown are for reference only and may differ based on size
- Option for Keyed or E-Lock, different GoCUID, please see product descriptions
- **All metal credenzas are extended lead time items of 6-8 weeks**

- Rangement en métal avec dessus en stratifié
- Les modules ne sont pas réversibles, sélectionner une configuration gauche ou droite, selon vos besoins
- Peut être utilisé avec des surfaces chevauchantes et espaceurs. Destiné à être utilisé avec la gamme Licence.
- Les configurations présentées sont à titre de référence seulement et peuvent différer en fonction de la taille
- Option serrure à clé ou électronique, voir les descriptions de produits
- **Toutes les crédences en métal ont un délai de production de 6-8 semaines**

* Please note the GoCUID used for this product is also applicable for other product combinations. The price shown is specific to the combination of components therein and may be shown below Ceiling Price.

* Veuillez noter que le GoCUID utilisé pour ce produit est également applicable à d'autres combinaisons de produits. Le prix indiqué est spécifique à la combinaison des composants et peut être inférieur au prix plafond

SAMPLE APPLICATION / EXEMPLE D'APPLICATION

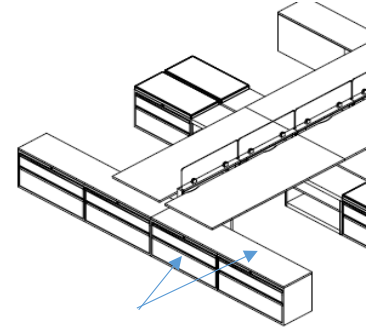

Credenza - Partial Height - Painted Metal
Crédence - Hauteur partielle - Métal peint

Open Shelf / Étagère ouverte

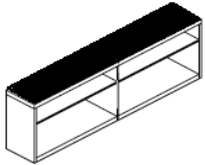

GoCUID / CIUGdC*	Price / Prix	D/P	W/L	H	WT LB	CU
1bCHHAX20L42XOSOSX	\$ 1,764.75	20	42	21	95	12.41
1bCHHAX20L60XOSOSX	\$ 3,305.25	20	60	21	136	18.52
1bCHHAX20L72XOSOSX	\$ 3,412.50	20	72	21	156	21.68
1bCHHAX24L42XOSOSX	\$ 1,840.80	24	42	21	95	12.41
1bCHHAX24L60XOSOSX	\$ 3,433.30	24	60	21	136	18.52
1bCHHAX24L72XOSOSX	\$ 3,580.20	24	72	21	156	21.68

REQUIRED SPECIFICATIONS / SPÉCIFICATIONS REQUISES

- Laminate / Stratifié Included/Inclus
- Metal / Métal Included/Inclus

Door - Open Shelf / Portes + étagère ouverte

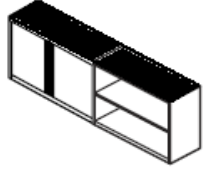

GoCUID / CIUGdC*	Price / Prix	D/P	W/L	H	WT LB	CU
1bCHHAX20L60XOSDDXS	\$ 3,393.00	20	60	21	223	18.52
1bCHHAX20L72XOSDDXS	\$ 3,479.45	20	72	21	260	21.68
1bCHHAX24L60XOSDDXS	\$ 3,435.25	24	60	21	223	18.52
1bCHHAX24L72XOSDDXS	\$ 3,653.00	24	72	21	260	21.68
1bCHHAX20L60XOSDDXK	\$ 3,718.65	20	60	21	223	18.52
1bCHHAX20L72XOSDDXK	\$ 3,805.10	20	72	21	260	21.68
1bCHHAX24L60XOSDDXK	\$ 3,777.80	24	60	21	223	18.52
1bCHHAX24L72XOSDDXK	\$ 3,978.65	24	72	21	260	21.68

Key / Clé

Electronic /
Électronique

Open Shelf - Door / Étagère ouverte + portes

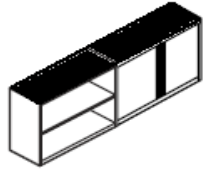

GoCUID / CIUGdC*	Price / Prix	D/P	W/L	H	WT LB	CU
1bCHHAX20L60XDDOSXS	\$ 3,393.00	20	60	21	223	18.52
1bCHHAX20L72XDDOSXS	\$ 3,479.45	20	72	21	260	21.68
1bCHHAX24L60XDDOSXS	\$ 3,435.25	24	60	21	223	18.52
1bCHHAX24L72XDDOSXS	\$ 3,653.00	24	72	21	260	21.68
1bCHHAX20L60XDDOSXK	\$ 3,718.65	20	60	21	223	18.52
1bCHHAX20L72XDDOSXK	\$ 3,805.10	20	72	21	260	21.68
1bCHHAX24L60XDDOSXK	\$ 3,777.80	24	60	21	223	18.52
1bCHHAX24L72XDDOSXK	\$ 3,978.65	24	72	21	260	21.68

Key / Clé

Electronic /
Électronique

REQUIRED SPECIFICATIONS / SPÉCIFICATIONS REQUISES

- Laminate / Stratifié Included/Inclus
- Metal / Métal Included/Inclus

Door / Portes

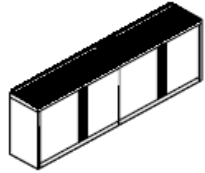

GoCUID / CIUGdC*	Price / Prix	D/P	W/L	H	WT LB	CU
1bCHHAX20L42XDDDDXS	\$ 1,837.55	20	42	21	164	9.50
1bCHHAX20L60XDDDDXS	\$ 3,480.75	20	60	21	264	18.52
1bCHHAX20L72XDDDDXS	\$ 3,546.40	20	72	21	364	21.68
1bCHHAX24L42XDDDDXS	\$ 1,918.80	24	42	21	164	9.50
1bCHHAX24L60XDDDDXS	\$ 3,437.20	24	60	21	264	18.52
1bCHHAX24L72XDDDDXS	\$ 3,725.80	24	72	21	364	21.68
1bCHHAX20L42XDDDDXK	\$ 2,163.20	20	42	21	164	9.50
1bCHHAX20L60XDDDDXK	\$ 4,132.05	20	60	21	264	18.52
1bCHHAX20L72XDDDDXK	\$ 4,197.70	20	72	21	364	21.68
1bCHHAX24L42XDDDDXK	\$ 2,244.45	24	42	21	164	9.50
1bCHHAX24L60XDDDDXK	\$ 4,122.30	24	60	21	264	18.52
1bCHHAX24L72XDDDDXK	\$ 4,377.10	24	72	21	364	21.68

Key / Clé

Electronic /
Électronique

Box/File Drawer - Open Shelf / Tiroir utilité/tiroir classeur + étagère ouverte

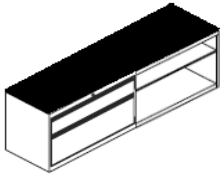

GoCUID / CIUGdC*	Price / Prix	D/P	W/L	H	WT LB	CU
1bCHHAX20L42XOSBFXS	\$ 1,958.45	20	42	21	195	12.41
1bCHHAX20L60XOSBFXS	\$ 3,449.55	20	60	21	233	18.52
1bCHHAX20L72XOSBFXS	\$ 3,536.65	20	72	21	285	21.68
1bCHHAX24L42XOSBFXS	\$ 2,048.80	24	42	21	195	12.41
1bCHHAX24L60XOSBFXS	\$ 3,135.60	24	60	21	233	18.52
1bCHHAX24L72XOSBFXS	\$ 3,715.40	24	72	21	285	21.68
1bCHHAX20L42XOSBFXK	\$ 2,284.10	20	42	21	195	12.41
1bCHHAX20L60XOSBFXK	\$ 3,775.20	20	60	21	233	18.52
1bCHHAX20L72XOSBFXK	\$ 3,862.30	20	72	21	285	21.68
1bCHHAX24L42XOSBFXK	\$ 2,376.40	24	42	21	195	12.41
1bCHHAX24L60XOSBFXK	\$ 3,461.90	24	60	21	233	18.52
1bCHHAX24L72XOSBFXK	\$ 4,041.05	24	72	21	285	21.68

Key / Clé

Electronic /
Électronique

REQUIRED SPECIFICATIONS / SPÉCIFICATIONS REQUISES

- Laminate / Stratifié Included/Inclus
- Metal / Métal Included/Inclus

Open Shelf - Box/File Drawer / Étagère ouverte + tiroir utilisé/tiroir classeur

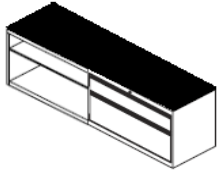

GoCUID / CIUGdC*	Price / Prix	D/P	W/L	H	WT LB	CU
1bCHHAX20L42XBFOXS	\$ 1,958.45	20	42	21	195	12.41
1bCHHAX20L60XBFOXS	\$ 3,449.55	20	60	21	233	18.52
1bCHHAX20L72XBFOXS	\$ 3,536.65	20	72	21	285	21.68
1bCHHAX20L42XBFOXS	\$ 2,048.80	24	42	21	195	12.41
1bCHHAX20L60XBFOXS	\$ 3,135.60	24	60	21	233	18.52
1bCHHAX20L72XBFOXS	\$ 3,715.40	24	72	21	285	21.68
1bCHHAX20L42XBFOXK	\$ 2,284.10	20	42	21	195	12.41
1bCHHAX20L60XBFOXK	\$ 3,775.20	20	60	21	233	18.52
1bCHHAX20L72XBFOXK	\$ 3,862.30	20	72	21	285	21.68
1bCHHAX20L42XBFOXK	\$ 2,376.40	24	42	21	195	12.41
1bCHHAX20L60XBFOXK	\$ 3,461.90	24	60	21	233	18.52
1bCHHAX20L72XBFOXK	\$ 4,041.05	24	72	21	285	21.68

Key / Clé

Electronic /
Électronique

Box/File Drawer / Tiroirs utilisé/tiroirs classeur

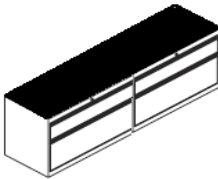

GoCUID / CIUGdC*	Price / Prix	D/P	W/L	H	WT LB	CU
1bCHHAX20L42XBFBS	\$ 1,884.35	20	42	21	210	12.41
1bCHHAX20L60XBFBS	\$ 3,593.85	20	60	21	304	18.52
1bCHHAX20L72XBFBS	\$ 3,660.80	20	72	21	364	21.68
1bCHHAX24L42XBFBS	\$ 1,968.85	24	42	21	210	12.41
1bCHHAX24L60XBFBS	\$ 2,837.90	24	60	21	304	18.52
1bCHHAX24L72XBFBS	\$ 3,850.60	24	72	21	364	21.68
1bCHHAX20L42XBFBSK	\$ 2,210.00	20	42	21	210	12.41
1bCHHAX20L60XBFBSK	\$ 4,245.15	20	60	21	304	18.52
1bCHHAX20L72XBFBSK	\$ 4,312.10	20	72	21	364	21.68
1bCHHAX24L42XBFBS	\$ 2,294.50	24	42	21	210	12.41
1bCHHAX24L60XBFBS	\$ 3,490.50	24	60	21	304	18.52
1bCHHAX24L72XBFBS	\$ 4,501.90	24	72	21	364	21.68

Key / Clé

Electronic /
Électronique

REQUIRED SPECIFICATIONS / SPÉCIFICATIONS REQUISES

- Laminate / Stratifié Included/Inclus
- Metal / Métal Included/Inclus

File Drawer - Open Shelf / Tiroir classeur + étagère ouverte

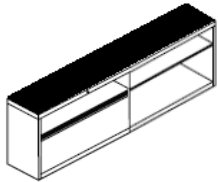

GoCUID / CIUGdC*	Price / Prix	D/P	W/L	H	WT LB	CU
1bCHHAX20L42XOSFFXS	\$ 1,805.05	20	42	29	195	12.41
1bCHHAX20L60XOSFFXS	\$ 3,449.55	20	60	29	233	18.52
1bCHHAX20L72XOSFFXS	\$ 3,536.65	20	72	29	285	21.68
1bCHHAX24L42XOSFFXS	\$ 1,883.70	24	42	29	195	12.41
1bCHHAX24L60XOSFFXS	\$ 3,135.60	24	60	29	233	18.52
1bCHHAX24L72XOSFFXS	\$ 3,715.40	24	72	29	285	21.68
1bCHHAX20L42XOSFFXK	\$ 2,130.70	20	42	29	195	12.41
1bCHHAX20L60XOSFFXK	\$ 3,775.20	20	60	29	233	18.52
1bCHHAX20L72XOSFFXK	\$ 3,862.30	20	72	29	285	21.68
1bCHHAX24L42XOSFFXK	\$ 2,209.35	24	42	29	195	12.41
1bCHHAX24L60XOSFFXK	\$ 3,461.90	24	60	29	233	18.52
1bCHHAX24L72XOSFFXK	\$ 4,041.05	24	72	29	285	21.68

Key / Clé

Electronic /
Électronique

Open Shelf - File Drawer / Étagère ouverte + tiroir classeur

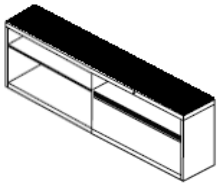

GoCUID / CIUGdC*	Price / Prix	D/P	W/L	H	WT LB	CU
1bCHHAX20L42XFOSXS	\$ 1,805.05	20	42	29	195	12.41
1bCHHAX20L60XFOSXS	\$ 3,449.55	20	60	29	233	18.52
1bCHHAX20L72XFOSXS	\$ 3,536.65	20	72	29	285	21.68
1bCHHAX24L42XFOSXS	\$ 1,883.70	24	42	29	195	12.41
1bCHHAX24L60XFOSXS	\$ 3,135.60	24	60	29	233	18.52
1bCHHAX24L72XFOSXS	\$ 3,715.40	24	72	29	285	21.68
1bCHHAX20L42XFOSXK	\$ 2,130.70	20	42	29	195	12.41
1bCHHAX20L60XFOSXK	\$ 3,775.20	20	60	29	233	18.52
1bCHHAX20L72XFOSXK	\$ 3,862.30	20	72	29	285	21.68
1bCHHAX24L42XFOSXK	\$ 2,209.35	24	42	29	195	12.41
1bCHHAX24L60XFOSXK	\$ 3,461.90	24	60	29	233	18.52
1bCHHAX24L72XFOSXK	\$ 4,041.05	24	72	29	285	21.68

Key / Clé

Electronic /
Électronique

REQUIRED SPECIFICATIONS / SPÉCIFICATIONS REQUISES

- Laminate / Stratifié Included/Inclus
- Metal / Métal Included/Inclus

File Drawer / Tiroirs classeur

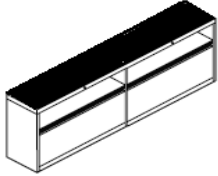

GoCUID / CIUGdC*	Price / Prix	D/P	W/L	H	WT LB	CU
1bCHHAX20L42XFFFFXS	\$ 1,884.35	20	42	29	210	12.41
1bCHHAX20L60XFFFFXS	\$ 3,593.85	20	60	29	304	18.52
1bCHHAX20L72XFFFFXS	\$ 3,660.80	20	72	29	364	21.68
1bCHHAX24L42XFFFFXS	\$ 1,968.85	24	42	29	210	12.41
1bCHHAX24L60XFFFFXS	\$ 2,837.90	24	60	29	304	18.52
1bCHHAX24L72XFFFFXS	\$ 3,850.60	24	72	29	364	21.68
1bCHHAX20L42XFFFFXK	\$ 2,210.00	20	42	29	210	12.41
1bCHHAX20L60XFFFFXK	\$ 4,245.15	20	60	29	304	18.52
1bCHHAX20L72XFFFFXK	\$ 4,312.10	20	72	29	364	21.68
1bCHHAX24L42XFFFFXK	\$ 2,294.50	24	42	29	210	12.41
1bCHHAX24L60XFFFFXK	\$ 3,490.50	24	60	29	304	18.52
1bCHHAX24L72XFFFFXK	\$ 4,501.90	24	72	29	364	21.68

Key / Clé

Electronic /
Électronique

File Drawer -Door / Tiroir classeur + portes

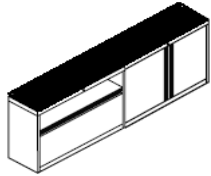

GoCUID / CIUGdC*	Price / Prix	D/P	W/L	H	WT LB	CU
1bCHHAX20L60XDDFFXS	\$ 3,537.30	20	60	29	307	18.52
1bCHHAX20L72XDDFFXS	\$ 3,603.60	20	72	29	364	21.68
1bCHHAX24L60XDDFFXS	\$ 3,137.55	24	60	29	307	18.52
1bCHHAX24L72XDDFFXS	\$ 3,788.20	24	72	29	364	21.68
1bCHHAX20L60XDDFFXK	\$ 4,188.60	20	60	29	307	18.52
1bCHHAX20L72XDDFFXK	\$ 4,254.90	20	72	29	364	21.68
1bCHHAX24L60XDDFFXK	\$ 3,806.40	24	60	29	307	18.52
1bCHHAX24L72XDDFFXK	\$ 4,439.50	24	72	29	364	21.68

Key / Clé

Electronic /
Électronique

REQUIRED SPECIFICATIONS / SPÉCIFICATIONS REQUISES

- Laminate / Stratifié Included/Inclus
- Metal / Métal Included/Inclus

Door - File Drawer / Portes + tiroir classeur

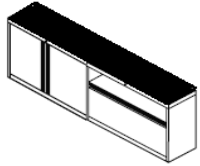

GoCUID / CIUGdC*	Price / Prix	D/P	W/L	H	WT LB	CU
1bCHHAX20L60XFFDDXS	\$ 3,537.30	20	60	29	307	18.52
1bCHHAX20L72XFFDDXS	\$ 3,603.60	20	72	29	364	21.68
1bCHHAX24L60XFFDDXS	\$ 3,137.55	24	60	29	307	18.52
1bCHHAX24L72XFFDDXS	\$ 3,788.20	24	72	29	364	21.68
1bCHHAX20L60XFFDDXK	\$ 4,188.60	20	60	29	307	18.52
1bCHHAX20L72XFFDDXK	\$ 4,254.90	20	72	29	364	21.68
1bCHHAX24L60XFFDDXK	\$ 3,806.40	24	60	29	307	18.52
1bCHHAX24L72XFFDDXK	\$ 4,439.50	24	72	29	364	21.68

Key / Clé

Electronic /
Électronique

File Drawer -Box/File Drawer / Tiroirs classeur + tiroir utilité/tiroir classeur

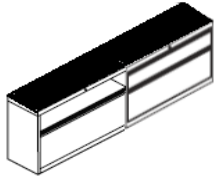

GoCUID / CIUGdC*	Price / Prix	D/P	W/L	H	WT LB	CU
1bCHHAX20L42XBFFFXS	\$ 1,884.35	20	42	29	210	12.41
1bCHHAX20L60XBFFFXS	\$ 3,593.85	20	60	29	304	18.52
1bCHHAX20L72XBFFFXS	\$ 3,660.80	20	72	29	364	21.68
1bCHHAX24L42XBFFFXS	\$ 1,968.85	24	42	29	210	12.41
1bCHHAX24L60XBFFFXS	\$ 2,837.90	24	60	29	304	18.52
1bCHHAX24L72XBFFFXS	\$ 3,850.60	24	72	29	364	21.68
1bCHHAX20L42XBFFFXK	\$ 2,210.00	20	42	29	210	12.41
1bCHHAX20L60XBFFFXK	\$ 4,245.15	20	60	29	304	18.52
1bCHHAX20L72XBFFFXK	\$ 4,312.10	20	72	29	364	21.68
1bCHHAX24L42XBFFFXK	\$ 2,294.50	24	42	29	210	12.41
1bCHHAX24L60XBFFFXK	\$ 3,490.50	24	60	29	304	18.52
1bCHHAX24L72XBFFFXK	\$ 4,501.90	24	72	29	364	21.68

Key / Clé

Electronic /
Électronique

REQUIRED SPECIFICATIONS / SPÉCIFICATIONS REQUISES

- Laminate / Stratifié Included/Inclus
- Metal / Métal Included/Inclus

Box/File Drawer - File Drawer / Tiroir utilité/tiroir classeur + tiroir classeur

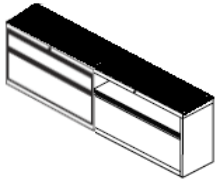

GoCUID / CIUGdC*	Price / Prix	D/P	W/L	H	WT LB	CU
1bCHHAX20L42XFFBFXS	\$ 1,884.35	20	42	29	210	12.41
1bCHHAX20L60XFFBFXS	\$ 3,593.85	20	60	29	304	18.52
1bCHHAX20L72XFFBFXS	\$ 3,660.80	20	72	29	364	21.68
1bCHHAX24L42XFFBFXS	\$ 1,968.85	24	42	29	210	12.41
1bCHHAX24L60XFFBFXS	\$ 2,837.90	24	60	29	304	18.52
1bCHHAX24L72XFFBFXS	\$ 3,850.60	24	72	29	364	21.68
1bCHHAX20L42XFFBFXK	\$ 2,210.00	20	42	29	210	12.41
1bCHHAX20L60XFFBFXK	\$ 4,245.15	20	60	29	304	18.52
1bCHHAX20L72XFFBFXK	\$ 4,312.10	20	72	29	364	21.68
1bCHHAX24L42XFFBFXK	\$ 2,294.50	24	42	29	210	12.41
1bCHHAX24L60XFFBFXK	\$ 3,490.50	24	60	29	304	18.52
1bCHHAX24L72XFFBFXK	\$ 4,501.90	24	72	29	364	21.68

Key / Clé

Electronic /
Électronique

Door - Box/File Drawer / Portes + tiroir utilité/tiroir classeur

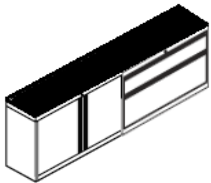

GoCUID / CIUGdC*	Price / Prix	D/P	W/L	H	WT LB	CU
1bCHHAX20L60XBFDDXS	\$ 3,537.30	20	60	29	307	18.52
1bCHHAX20L72XBFDDXS	\$ 3,603.60	20	72	29	364	21.68
1bCHHAX24L60XBFDDXS	\$ 3,137.55	24	60	29	307	18.52
1bCHHAX24L72XBFDDXS	\$ 3,788.20	24	72	29	364	21.68
1bCHHAX20L60XBFDDXK	\$ 4,188.60	20	60	29	307	18.52
1bCHHAX20L72XBFDDXK	\$ 4,254.90	20	72	29	364	21.68
1bCHHAX24L60XBFDDXK	\$ 3,806.40	24	60	29	307	18.52
1bCHHAX24L72XBFDDXK	\$ 4,439.50	24	72	29	364	21.68

Key / Clé

Electronic /
Électronique

REQUIRED SPECIFICATIONS / SPÉCIFICATIONS REQUISES

- Laminate / Stratifié Included/Inclus
- Metal / Métal Included/Inclus

Box/File Drawer - Door / Tiroir utilité/tiroir classeur + portes

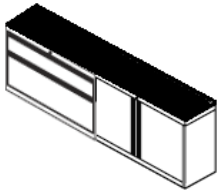

GoCUID / CIUGdC*	Price / Prix	D/P	W/L	H	WT LB	CU
1bCHHAX20L60XDDBFXS	\$ 3,537.30	20	60	29	307	18.52
1bCHHAX20L72XDDBFXS	\$ 3,603.60	20	72	29	364	21.68
1bCHHAX24L60XDDBFXS	\$ 3,137.55	24	60	29	307	18.52
1bCHHAX24L72XDDBFXS	\$ 3,788.20	24	72	29	364	21.68
1bCHHAX20L60XDDBFXK	\$ 4,188.60	20	60	29	307	18.52
1bCHHAX20L72XDDBFXK	\$ 4,254.90	20	72	29	364	21.68
1bCHHAX24L60XDDBFXK	\$ 3,806.40	24	60	29	307	18.52
1bCHHAX24L72XDDBFXK	\$ 4,439.50	24	72	29	364	21.68

Key / Clé

Electronic /
Électronique

REQUIRED SPECIFICATIONS / SPÉCIFICATIONS REQUISES

- Laminate / Stratifié Included/Inclus
- Metal / Métal Included/Inclus

Grand & Toy

E60PQ-140003/045/PQ

CATEGORY 1B - CREDENZAS - PARTIAL HEIGHT - 1200 SERIES

APPLICATION NOTES / INSTRUCTIONS D'APPLICATION

- All hutches are surface mounted and secured.
- Units are handed, please select left or right configurations as required
- Intended for use with Licence series desks and credenzas
- Only 36"H units may be used on Full Height Credenzas
- Configurations shown are for reference only and may differ based on size
- **Items marked with a " * " are an extended lead time of 6 weeks**

- Toutes les hutches sont montées sur la surface de travail et sécurisées.
- Destiné à être utilisé avec les bureaux et crédences de la gamme Licence
- Les modules ne sont pas réversibles, sélectionner une configuration gauche ou droite, selon vos besoins
- Seuls les modules 36 po H peuvent être utilisés sur les crédences pleine hauteur
- Les configurations présentées sont à titre de référence seulement et peuvent différer en fonction de la taille
- **Les articles marqués d'un " * " ont un délai de production de 6 semaines**

* Please note the GoCUID used for this product may also applicable for other product combinations. The price shown is specific to the combination of components therein and may be shown below Ceiling Price.

* Veuillez noter que le GoCUID utilisé pour ce produit est également applicable à d'autres combinaisons de produits. Le prix indiqué est spécifique à la combinaison des composants et peut être inférieur au prix plafond

SAMPLE APPLICATION / EXEMPLE D'APPLICATION

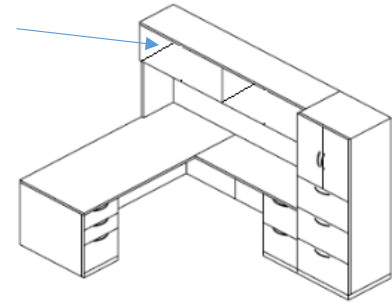

Hutches and Overheads - Hutch Open - Laminate - Surface Mount without Gables

Huches et rangements surélevés - Huche ouverte - Stratifié - Montage sur surface de travail, sans côtés

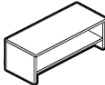
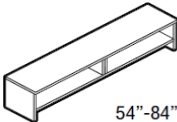
	GoCUID / CIUGdC*	Price / Prix	D/P	W/L	H	WT LB	CU
 <p>30"-48" 21" high units</p> <p>30 po à 48 po L=modules 21 po H</p>	1bHHOAS12L30XXXXXXXX*	\$ 220.35	12	30	21	73	11.00
	1bHHOLO12L36XXXXXXXX*	\$ 240.50	12	36	21	81	13.00
	1bHHOLO12L42XXXXXXXX*	\$ 268.45	12	42	21	96	15.00
	1bHHOLO12L48XXXXXXXX*	\$ 298.35	12	48	21	100	18.00
	1bHHOLO12L54XXXXXXXX*	\$ 358.80	12	54	21	124	20.00
	1bHHOLO12L60XXXXXXXX*	\$ 371.15	12	60	21	134	22.00
	1bHHOLO12L66XXXXXXXX*	\$ 395.85	12	66	21	144	24.00
	1bHHOLO12L72XXXXXXXX*	\$ 410.80	12	72	21	152	26.00
	1bHHOLO12L78XXXXXXXX*	\$ 434.85	12	78	21	161	29.00
	1bHHOLO12L84XXXXXXXX*	\$ 455.65	12	84	21	169	31.00
 <p>54"-84" 21" high units</p> <p>54 po à 84 po L=modules 21 po H</p>	1bHHOLO15L30XXXXXXXX	\$ 220.35	15	30	21	73	11.00
	1bHHOLO15L36XXXXXXXX	\$ 240.50	15	36	21	81	13.00
	1bHHOLO15L42XXXXXXXX	\$ 268.45	15	42	21	96	15.00
	1bHHOLO15L48XXXXXXXX	\$ 298.35	15	48	21	100	18.00
	1bHHOLO15L54XXXXXXXX	\$ 358.80	15	54	21	124	20.00
	1bHHOLO15L60XXXXXXXX	\$ 371.15	15	60	21	134	22.00
	1bHHOLO15L66XXXXXXXX	\$ 395.85	15	66	21	144	24.00
	1bHHOLO15L72XXXXXXXX	\$ 410.80	15	72	21	152	26.00
	1bHHOLO15L78XXXXXXXX	\$ 434.85	15	78	21	161	29.00
	1bHHOLO15L84XXXXXXXX	\$ 455.65	15	84	21	169	31.00

REQUIRED SPECIFICATIONS / SPÉCIFICATIONS REQUISES

- Laminate / Stratifié

Hutches and Overheads - Hutch Open - Laminate - Surface Mount with Gables

Huches et rangements surélevés - Huche ouverte - Stratifié - Montage sur surface de travail, avec côtés

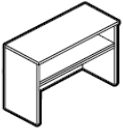
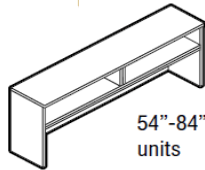
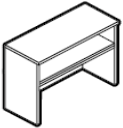
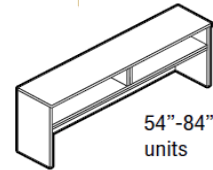
	GoCUID / CIUGdC*	Price / Prix	D/P	W/L	H	WT LB	CU
 <p>30"-48" units</p> <p>Modules 30 po à 48 po L</p>	1bHHOLO12L30XXXXXXXX*	\$ 269.10	12	30	36		
	1bHHOLS12L36XXXXXXXX*	\$ 291.85	12	36	36		
	1bHHOLS12L42XXXXXXXX*	\$ 321.75	12	42	36		
	1bHHOLS12L48XXXXXXXX*	\$ 371.80	12	48	36		
	1bHHOLS12L54XXXXXXXX*	\$ 421.20	12	54	36		
	1bHHOLS12L60XXXXXXXX*	\$ 436.15	12	60	36		
	1bHHOLS12L66XXXXXXXX*	\$ 464.10	12	66	36		
	1bHHOLS12L72XXXXXXXX*	\$ 485.55	12	72	36		
	1bHHOLS12L78XXXXXXXX*	\$ 510.90	12	78	36		
	1bHHOLS12L84XXXXXXXX*	\$ 537.55	12	84	36		
 <p>54"-84" units</p> <p>Modules 54 po à 84 po L</p>	1bHHOLS15L30XXXXXXXX	\$ 269.10	15	30	36		
	1bHHOLS15L36XXXXXXXX	\$ 291.85	15	36	36		
	1bHHOLS15L42XXXXXXXX	\$ 321.75	15	42	36		
	1bHHOLS15L48XXXXXXXX	\$ 371.80	15	48	36		
	1bHHOLS15L54XXXXXXXX	\$ 421.20	15	54	36		
	1bHHOLS15L60XXXXXXXX	\$ 436.15	15	60	36		
	1bHHOLS15L66XXXXXXXX	\$ 464.10	15	66	36		
	1bHHOLS15L72XXXXXXXX	\$ 485.55	15	72	36		
	1bHHOLS15L78XXXXXXXX	\$ 510.90	15	78	36		
	1bHHOLS15L84XXXXXXXX	\$ 537.55	15	84	36		
 <p>30"-48" units</p> <p>Modules 30 po à 48 po L</p>	1bHHOLO12L30XXXXXXXX*	\$ 462.00	12	30	43		
	1bHHOLS12L36XXXXXXXX*	\$ 486.00	12	36	43		
	1bHHOLS12L42XXXXXXXX*	\$ 574.00	12	42	43		
	1bHHOLS12L48XXXXXXXX*	\$ 612.00	12	48	43		
	1bHHOLS12L54XXXXXXXX*	\$ 698.00	12	54	43		
	1bHHOLS12L60XXXXXXXX*	\$ 763.00	12	60	43		
	1bHHOLS12L66XXXXXXXX*	\$ 809.00	12	66	43		
	1bHHOLS12L72XXXXXXXX*	\$ 868.00	12	72	43		
	1bHHOLS12L78XXXXXXXX*	\$ 885.00	12	78	43		
	1bHHOLS12L84XXXXXXXX*	\$ 928.00	12	84	43		
 <p>54"-84" units</p> <p>Modules 54 po à 84 po L</p>	1bHHOLS15L30XXXXXXXX	\$ 462.00	15	30	43		
	1bHHOLS15L36XXXXXXXX	\$ 486.00	15	36	43		
	1bHHOLS15L42XXXXXXXX	\$ 574.00	15	42	43		
	1bHHOLS15L48XXXXXXXX	\$ 612.00	15	48	43		
	1bHHOLS15L54XXXXXXXX	\$ 698.00	15	54	43		
	1bHHOLS15L60XXXXXXXX	\$ 763.00	15	60	43		
	1bHHOLS15L66XXXXXXXX	\$ 809.00	15	66	43		
	1bHHOLS15L72XXXXXXXX	\$ 868.00	15	72	43		
	1bHHOLS15L78XXXXXXXX	\$ 885.00	15	78	43		
	1bHHOLS15L84XXXXXXXX	\$ 928.00	15	84	43		

REQUIRED SPECIFICATIONS / SPÉCIFICATIONS REQUISES

Grand & Toy

E60PQ-140003/045/PQ

CATEGORY 1B - HUTCHES - LICENCE

- Laminate / Stratifié

Included/Inclus

Hutches and Overheads - Hutch Close - Laminate - Surface Mount without Gables

Huches et rangements surélevés- Huche fermée - Stratifié - Montage sur surface de travail, sans côtés

Single Sliding / Coulissante simple

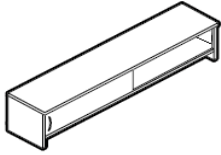

GoCUID / CIUGdC*	Price / Prix	D/P	W/L	H	WT LB	CU
1bHHCLO12L30XSLXXX*	\$ 495.30	12	30	21	92	12.00
1bHHCLO12L36XSLXXX*	\$ 495.30	12	36	21	102	14.00
1bHHCLO12L42XSLXXX*	\$ 495.30	12	42	21	112	16.00
1bHHCLO12L48XSLXXX*	\$ 495.30	12	48	21	122	18.00
1bHHCLO12L54XSLXXX*	\$ 543.40	12	54	21	146	20.00
1bHHCLO12L60XSLXXX*	\$ 562.25	12	60	21	156	22.00
1bHHCLO12L66XSLXXX*	\$ 598.65	12	66	21	166	24.00
1bHHCLO12L72XSLXXX*	\$ 616.20	12	72	21	174	26.00
1bHHCLO12L78XSLXXX*	\$ 646.10	12	78	21	183	29.00
1bHHCLO12L84XSLXXX*	\$ 665.60	12	84	21	191	31.00
1bHHCLO15L30XSLXXX*	\$ 495.30	15	30	21	92	12.00
1bHHCLO15L36XSLXXX*	\$ 495.30	15	36	21	102	14.00
1bHHCLO15L42XSLXXX*	\$ 495.30	15	42	21	112	16.00
1bHHCLO15L48XSLXXX*	\$ 495.30	15	48	21	122	18.00
1bHHCLO15L54XSLXXX*	\$ 543.40	15	54	21	146	20.00
1bHHCLO15L60XSLXXX*	\$ 562.25	15	60	21	156	22.00
1bHHCLO15L66XSLXXX*	\$ 598.65	15	66	21	166	24.00
1bHHCLO15L72XSLXXX*	\$ 616.20	15	72	21	174	26.00
1bHHCLO15L78XSLXXX*	\$ 646.10	15	78	21	183	29.00
1bHHCLO15L84XSLXXX*	\$ 665.60	15	84	21	191	31.00

Key / Clé

- Please indicate left or right side locking

- Veuillez indiquer le verrouillage du côté gauche ou droit

REQUIRED SPECIFICATIONS / SPÉCIFICATIONS REQUISES

- Laminate / Stratifié

Included/Inclus

- Handle / Poignée

Included/Inclus

By Pass Sliding / Coulissante à rail d'évitement

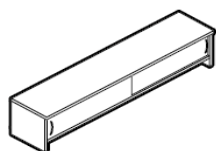

GoCUID / CIUGdC*	Price / Prix	D/P	W/L	H	WT LB	CU
1bHHCLO12L30XBPXXXS*	\$ 495.30	12	30	21	73	11.00
1bHHCLO12L36XBPXXXS*	\$ 495.30	12	36	21	81	13.00
1bHHCLO12L42XBPXXXS*	\$ 495.30	12	42	21	96	15.00
1bHHCLO12L48XBPXXXS*	\$ 495.30	12	48	21	100	18.00
1bHHCLO12L54XBPXXXS*	\$ 543.40	12	54	21	124	20.00
1bHHCLO12L60XBPXXXS*	\$ 562.25	12	60	21	134	22.00
1bHHCLO12L66XBPXXXS*	\$ 598.65	12	66	21	144	24.00
1bHHCLO12L72XBPXXXS*	\$ 616.20	12	72	21	152	26.00
1bHHCLO12L78XBPXXXS*	\$ 646.10	12	78	21	161	29.00
1bHHCLO12L84XBPXXXS*	\$ 665.60	12	84	21	169	31.00
1bHHCLO15L30XBPXXXS	\$ 495.30	15	30	21	73	11.00
1bHHCLO15L36XBPXXXS	\$ 495.30	15	36	21	81	13.00
1bHHCLO15L42XBPXXXS	\$ 495.30	15	42	21	96	15.00
1bHHCLO15L48XBPXXXS	\$ 495.30	15	48	21	100	18.00
1bHHCLO15L54XBPXXXS	\$ 543.40	15	54	21	124	20.00
1bHHCLO15L60XBPXXXS	\$ 562.25	15	60	21	134	22.00
1bHHCLO15L66XBPXXXS	\$ 598.65	15	66	21	144	24.00
1bHHCLO15L72XBPXXXS	\$ 616.20	15	72	21	152	26.00
1bHHCLO15L78XBPXXXS	\$ 646.10	15	78	21	161	29.00
1bHHCLO15L84XBPXXXS	\$ 665.60	15	84	21	169	31.00

Key / Clé

REQUIRED SPECIFICATIONS / SPÉCIFICATIONS REQUISES

- Laminate / Stratifié Included/Inclus
- Handle / Poignée Included/Inclus

Flip Top / Rabattable

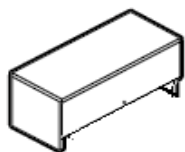

GoCUID / CIUGdC*	Price / Prix	D/P	W/L	H	WT LB	CU
1bHHCLO12L30XFTXXXS*	\$ 439.40	12	30	21	94	7.00
1bHHCLO12L36XFTXXXS*	\$ 442.00	12	36	21	103	8.00
1bHHCLO12L42XFTXXXS*	\$ 475.80	12	42	21	113	9.00
1bHHCLO12L48XFTXXXS*	\$ 509.60	12	48	21	123	10.00
1bHHCLO12L54XFTXXXS*	\$ 698.75	12	54	21	130	11.00
1bHHCLO12L60XFTXXXS*	\$ 754.65	12	60	21	141	12.00
1bHHCLO12L66XFTXXXS*	\$ 793.65	12	66	21	151	13.00
1bHHCLO12L72XFTXXXS*	\$ 815.10	12	72	21	163	15.00
1bHHCLO12L78XFTXXXS*	\$ 875.55	12	78	21	174	16.00
1bHHCLO12L84XFTXXXS*	\$ 908.05	12	84	21	186	17.00
1bHHCLO15L30XFTXXXS*	\$ 439.40	15	30	21	94	7.00
1bHHCLO15L36XFTXXXS*	\$ 442.00	15	36	21	103	8.00
1bHHCLO15L42XFTXXXS*	\$ 475.80	15	42	21	113	9.00
1bHHCLO15L48XFTXXXS*	\$ 509.60	15	48	21	123	10.00
1bHHCLO15L54XFTXXXS*	\$ 698.75	15	54	21	130	11.00
1bHHCLO15L60XFTXXXS*	\$ 754.65	15	60	21	141	12.00
1bHHCLO15L66XFTXXXS*	\$ 793.65	15	66	21	151	13.00
1bHHCLO15L72XFTXXXS*	\$ 815.10	15	72	21	163	15.00
1bHHCLO15L78XFTXXXS*	\$ 875.55	15	78	21	174	16.00
1bHHCLO15L84XFTXXXS*	\$ 908.05	15	84	21	186	17.00

Key / Clé



1bHHCLO12L30XFTXXXK*	\$ 543.40	12	30	21	94	7.00
1bHHCLO12L36XFTXXXK*	\$ 546.00	12	36	21	103	8.00
1bHHCLO12L42XFTXXXK*	\$ 579.80	12	42	21	113	9.00
1bHHCLO12L48XFTXXXK*	\$ 717.60	12	48	21	123	10.00
1bHHCLO12L54XFTXXXK*	\$ 906.75	12	54	21	130	11.00
1bHHCLO12L60XFTXXXK*	\$ 962.65	12	60	21	141	12.00
1bHHCLO12L66XFTXXXK*	\$ 1,001.65	12	66	21	151	13.00
1bHHCLO12L72XFTXXXK*	\$ 1,023.10	12	72	21	163	15.00
1bHHCLO12L78XFTXXXK*	\$ 1,083.55	12	78	21	174	16.00
1bHHCLO12L84XFTXXXK*	\$ 1,116.05	12	84	21	186	17.00
1bHHCLO15L30XFTXXXK*	\$ 543.40	15	30	21	94	7.00
1bHHCLO15L36XFTXXXK*	\$ 546.00	15	36	21	103	8.00
1bHHCLO15L42XFTXXXK*	\$ 579.80	15	42	21	113	9.00
1bHHCLO15L48XFTXXXK*	\$ 717.60	15	48	21	123	10.00
1bHHCLO15L54XFTXXXK*	\$ 906.75	15	54	21	130	11.00
1bHHCLO15L60XFTXXXK*	\$ 962.65	15	60	21	141	12.00
1bHHCLO15L66XFTXXXK*	\$ 1,001.65	15	66	21	151	13.00
1bHHCLO15L72XFTXXXK*	\$ 1,023.10	15	72	21	163	15.00
1bHHCLO15L78XFTXXXK*	\$ 1,083.55	15	78	21	174	16.00
1bHHCLO15L84XFTXXXK*	\$ 1,116.05	15	84	21	186	17.00

Electronic / Électronique

REQUIRED SPECIFICATIONS / SPÉCIFICATIONS REQUISES

- Laminate / Stratifié Included/Inclus
- Handle / Poignée Included/Inclus

Hutches and Overheads - Hutch Close - Laminate - Surface Mount without Gables
 Huches et rangements surélevés - Huche fermée - Stratifié - Montage sur surface de travail, sans côtés

Single Sliding / Coulissante simple

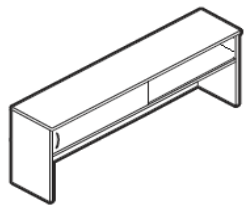

GoCUID / CIUGdC*	Price / Prix	D/P	W/L	H	WT LB	CU
1bHHCLS12L30XSLXXXS*	\$ 584.35	12	30	36	114	12.00
1bHHCLS12L36XSLXXXS*	\$ 584.35	12	36	36	123	16.00
1bHHCLS12L42XSLXXXS*	\$ 584.35	12	42	36	132	20.00
1bHHCLS12L48XSLXXXS*	\$ 584.35	12	48	36	141	24.00
1bHHCLS12L54XSLXXXS*	\$ 645.45	12	54	36	165	29.00
1bHHCLS12L60XSLXXXS*	\$ 660.40	12	60	36	175	31.00
1bHHCLS12L66XSLXXXS*	\$ 700.05	12	66	36	185	33.00
1bHHCLS12L72XSLXXXS*	\$ 718.90	12	72	36	193	36.00
1bHHCLS12L78XSLXXXS*	\$ 757.90	12	78	36	201	46.00
1bHHCLS12L84XSLXXXS*	\$ 773.50	12	84	36	210	50.00
1bHHCLS15L30XSLXXXS*	\$ 584.35	15	30	36	114	12.00
1bHHCLS15L36XSLXXXS*	\$ 584.35	15	36	36	123	16.00
1bHHCLS15L42XSLXXXS*	\$ 584.35	15	42	36	132	20.00
1bHHCLS15L48XSLXXXS*	\$ 584.35	15	48	36	141	24.00
1bHHCLS15L54XSLXXXS*	\$ 645.45	15	54	36	165	29.00
1bHHCLS15L60XSLXXXS*	\$ 660.40	15	60	36	175	31.00
1bHHCLS15L66XSLXXXS*	\$ 700.05	15	66	36	185	33.00
1bHHCLS15L72XSLXXXS*	\$ 718.90	15	72	36	193	36.00
1bHHCLS15L78XSLXXXS*	\$ 757.90	15	78	36	201	46.00
1bHHCLS15L84XSLXXXS*	\$ 773.50	15	84	36	210	50.00

Key / Clé

- Please indicate left or right side locking
- Veuillez indiquer le verrouillage du côté gauche ou droit

REQUIRED SPECIFICATIONS / SPÉCIFICATIONS REQUISES

- Laminate / Stratifié Included/Inclus
- Handle / Poignée Included/Inclus

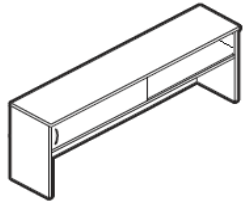

<i>GoCUID / CIUGdC*</i>	<i>Price / Prix</i>	<i>D/P</i>	<i>W/L</i>	<i>H</i>	<i>WT LB</i>	<i>CU</i>
1bHHCLS12L30XSLXXXS*	\$ 650.00	12	30	43	114	12.00
1bHHCLS12L36XSLXXXS*	\$ 650.00	12	36	43	123	16.00
1bHHCLS12L42XSLXXXS*	\$ 650.00	12	42	43	132	20.00
1bHHCLS12L48XSLXXXS*	\$ 650.00	12	48	43	141	24.00
1bHHCLS12L54XSLXXXS*	\$ 650.00	12	54	43	165	29.00
1bHHCLS12L60XSLXXXS*	\$ 718.25	12	60	43	175	31.00
1bHHCLS12L66XSLXXXS*	\$ 736.45	12	66	43	185	33.00
1bHHCLS12L72XSLXXXS*	\$ 780.00	12	72	43	193	36.00
1bHHCLS12L78XSLXXXS*	\$ 822.25	12	78	43	201	46.00
1bHHCLS12L84XSLXXXS*	\$ 871.65	12	84	43	210	50.00
1bHHCLS15L30XSLXXXS*	\$ 650.00	15	30	43	114	12.00
1bHHCLS15L36XSLXXXS*	\$ 650.00	15	36	43	123	16.00
1bHHCLS15L42XSLXXXS*	\$ 650.00	15	42	43	132	20.00
1bHHCLS15L48XSLXXXS*	\$ 650.00	15	48	43	141	24.00
1bHHCLS15L54XSLXXXS*	\$ 650.00	15	54	43	165	29.00
1bHHCLS15L60XSLXXXS*	\$ 718.25	15	60	43	175	31.00
1bHHCLS15L66XSLXXXS*	\$ 736.45	15	66	43	185	33.00
1bHHCLS15L72XSLXXXS*	\$ 780.00	15	72	43	193	36.00
1bHHCLS15L78XSLXXXS*	\$ 822.25	15	78	43	201	46.00
1bHHCLS15L84XSLXXXS*	\$ 871.65	15	84	43	210	50.00

Key / Clé

- Please indicate left or right side locking
- Veuillez indiquer le verrouillage du côté gauche ou droit

REQUIRED SPECIFICATIONS / SPÉCIFICATIONS REQUISES

- Laminate / Stratifié Included/Inclus
- Handle / Poignée Included/Inclus

Grand & Toy

E60PQ-140003/045/PQ

CATEGORY 1B - HUTCHES - LICENCE

By Pass Sliding / Coulissante à rail d'évitement

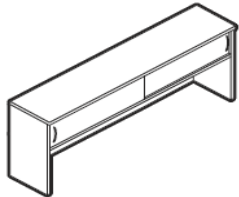

GoCUID / CIUGdC*	Price / Prix	D/P	W/L	H	WT LB	CU
1bHHCLS12L30XBPXXXS*	\$ 584.35	12	30	36	114	12.00
1bHHCLS12L36XBPXXXS*	\$ 584.35	12	36	36	123	16.00
1bHHCLS12L42XBPXXXS*	\$ 584.35	12	42	36	132	20.00
1bHHCLS12L48XBPXXXS*	\$ 584.35	12	48	36	141	24.00
1bHHCLS12L54XBPXXXS*	\$ 645.45	12	54	36	165	29.00
1bHHCLS12L60XBPXXXS*	\$ 660.40	12	60	36	175	31.00
1bHHCLS12L66XBPXXXS*	\$ 700.05	12	66	36	185	33.00
1bHHCLS12L72XBPXXXS*	\$ 718.90	12	72	36	193	36.00
1bHHCLS12L78XBPXXXS*	\$ 757.90	12	78	36	201	46.00
1bHHCLS12L84XBPXXXS*	\$ 773.50	12	84	36	210	50.00
1bHHCLS15L30XBPXXXS	\$ 584.35	15	30	36	114	12.00
1bHHCLS15L36XBPXXXS	\$ 584.35	15	36	36	123	16.00
1bHHCLS15L42XBPXXXS	\$ 584.35	15	42	36	132	20.00
1bHHCLS15L48XBPXXXS	\$ 584.35	15	48	36	141	24.00
1bHHCLS15L54XBPXXXS	\$ 645.45	15	54	36	165	29.00
1bHHCLS15L60XBPXXXS	\$ 660.40	15	60	36	175	31.00
1bHHCLS15L66XBPXXXS	\$ 700.05	15	66	36	185	33.00
1bHHCLS15L72XBPXXXS	\$ 718.90	15	72	36	193	36.00
1bHHCLS15L78XBPXXXS	\$ 757.90	15	78	36	201	46.00
1bHHCLS15L84XBPXXXS	\$ 773.50	15	84	36	210	50.00

Key / Clé

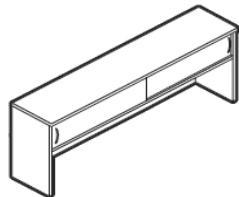

1bHHCLS12L30XBPXXXS*	\$ 650.00	12	30	43	114	12.00
1bHHCLS12L36XBPXXXS*	\$ 650.00	12	36	43	123	16.00
1bHHCLS12L42XBPXXXS*	\$ 650.00	12	42	43	132	20.00
1bHHCLS12L48XBPXXXS*	\$ 650.00	12	48	43	141	24.00
1bHHCLS12L54XBPXXXS*	\$ 650.00	12	54	43	165	29.00
1bHHCLS12L60XBPXXXS*	\$ 718.25	12	60	43	175	31.00
1bHHCLS12L66XBPXXXS*	\$ 736.45	12	66	43	185	33.00
1bHHCLS12L72XBPXXXS*	\$ 780.00	12	72	43	193	36.00
1bHHCLS12L78XBPXXXS*	\$ 822.25	12	78	43	201	46.00
1bHHCLS12L84XBPXXXS*	\$ 871.65	12	84	43	210	50.00
1bHHCLS15L30XBPXXXS	\$ 650.00	15	30	43	114	12.00
1bHHCLS15L36XBPXXXS	\$ 650.00	15	36	43	123	16.00
1bHHCLS15L42XBPXXXS	\$ 650.00	15	42	43	132	20.00
1bHHCLS15L48XBPXXXS	\$ 650.00	15	48	43	141	24.00
1bHHCLS15L54XBPXXXS	\$ 650.00	15	54	43	165	29.00
1bHHCLS15L60XBPXXXS	\$ 718.25	15	60	43	175	31.00
1bHHCLS15L66XBPXXXS	\$ 736.45	15	66	43	185	33.00
1bHHCLS15L72XBPXXXS	\$ 780.00	15	72	43	193	36.00
1bHHCLS15L78XBPXXXS	\$ 822.25	15	78	43	201	46.00

Key / Clé

Grand & Toy

E60PQ-140003/045/PQ

CATEGORY 1B - HUTCHES - LICENCE

1bHHCLS15L84XBPXXXS	\$ 871.65	15	84	43	210	50.00
---------------------	-----------	----	----	----	-----	-------

REQUIRED SPECIFICATIONS / SPÉCIFICATIONS REQUISES

- Laminate / Stratifié Included/Inclus
- Handle / Poignée Included/Inclus

Flip Top / Rabattable

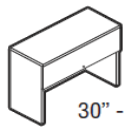

30" - 48" units

Modules 30 po à 48 po L

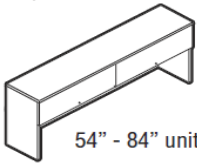

54" - 84" units

Modules 54 po à 84 po L

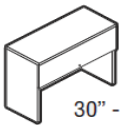

30" - 48" units

Modules 30 po à 48 po L

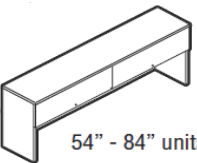

54" - 84" units

Modules 54 po à 84 po L

GoCUID / CIUGdC*	Price / Prix	D/P	W/L	H	WT LB	CU
1bHHCLS12L30XFTXXXS*	\$ 399.10	12	30	36	142	18.00
1bHHCLS12L36XFTXXXS*	\$ 425.75	12	36	36	146	19.00
1bHHCLS12L42XFTXXXS*	\$ 458.25	12	42	36	158	22.00
1bHHCLS12L48XFTXXXS*	\$ 460.85	12	48	36	180	24.00
1bHHCLS12L54XFTXXXS*	\$ 691.60	12	54	36	182	29.00
1bHHCLS12L60XFTXXXS*	\$ 733.85	12	60	36	220	31.00
1bHHCLS12L66XFTXXXS*	\$ 767.65	12	66	36	253	33.00
1bHHCLS12L72XFTXXXS*	\$ 791.05	12	72	36	259	36.00
1bHHCLS12L78XFTXXXS*	\$ 827.45	12	78	36	264	46.00
1bHHCLS12L84XFTXXXS*	\$ 858.00	12	84	36	275	50.00
1bHHCLS15L30XFTXXXS	\$ 399.10	15	30	36	142	18.00
1bHHCLS15L36XFTXXXS	\$ 425.75	15	36	36	146	19.00
1bHHCLS15L42XFTXXXS	\$ 458.25	15	42	36	158	22.00
1bHHCLS15L48XFTXXXS	\$ 460.85	15	48	36	180	24.00
1bHHCLS15L54XFTXXXS	\$ 691.60	15	54	36	182	29.00
1bHHCLS15L60XFTXXXS	\$ 733.85	15	60	36	220	31.00
1bHHCLS15L66XFTXXXS	\$ 767.65	15	66	36	253	33.00
1bHHCLS15L72XFTXXXS	\$ 791.05	15	72	36	259	36.00
1bHHCLS15L78XFTXXXS	\$ 827.45	15	78	36	264	46.00
1bHHCLS15L84XFTXXXS	\$ 858.00	15	84	36	275	50.00
1bHHCLS12L30XFTXXXS*	\$ 439.40	12	30	43	150	22.00
1bHHCLS12L36XFTXXXS*	\$ 442.00	12	36	43	154	26.00
1bHHCLS12L42XFTXXXS*	\$ 475.80	12	42	43	166	31.00
1bHHCLS12L48XFTXXXS*	\$ 509.60	12	48	43	188	35.00
1bHHCLS12L54XFTXXXS*	\$ 698.75	12	54	43	194	40.00
1bHHCLS12L60XFTXXXS*	\$ 754.65	12	60	43	232	44.00
1bHHCLS12L66XFTXXXS*	\$ 793.65	12	66	43	265	48.00
1bHHCLS12L72XFTXXXS*	\$ 815.10	12	72	43	271	53.00
1bHHCLS12L78XFTXXXS*	\$ 875.55	12	78	43	276	57.00
1bHHCLS12L84XFTXXXS*	\$ 908.05	12	84	43	287	62.00
1bHHCLS15L30XFTXXXS	\$ 439.40	15	30	43	150	22.00
1bHHCLS15L36XFTXXXS	\$ 442.00	15	36	43	154	26.00
1bHHCLS15L42XFTXXXS	\$ 475.80	15	42	43	166	31.00
1bHHCLS15L48XFTXXXS	\$ 509.60	15	48	43	188	35.00
1bHHCLS15L54XFTXXXS	\$ 698.75	15	54	43	194	40.00
1bHHCLS15L60XFTXXXS	\$ 754.65	15	60	43	232	44.00
1bHHCLS15L66XFTXXXS	\$ 793.65	15	66	43	265	48.00
1bHHCLS15L72XFTXXXS	\$ 815.10	15	72	43	271	53.00

Key / Clé

Key / Clé

Grand & Toy

E60PQ-140003/045/PQ

CATEGORY 1B - HUTCHES - LICENCE

1bHHCLS15L78XFTXXXS	\$ 875.55	15	78	43	276	57.00
1bHHCLS15L84XFTXXXS	\$ 908.05	15	84	43	287	62.00

REQUIRED SPECIFICATIONS / SPÉCIFICATIONS REQUISES

- Laminate / Stratifié Included/Inclus
- Handle / Poignée Included/Inclus

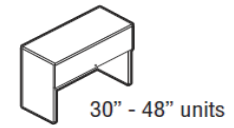

Modules 30 po à 48 po L

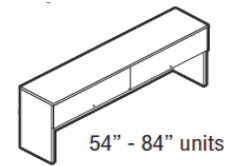

Modules 54 po à 84 po L

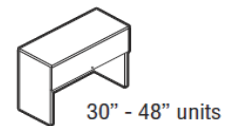

Modules 30 po à 48 po L

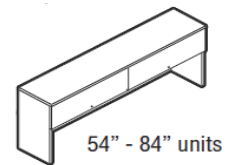

Modules 54 po à 84 po L



GoCUID / CIUGdC*	Price / Prix	D/P	W/L	H	WT LB	CU
1bHHCLS12L30XFTXXXS	\$ 506.35	12	30	36	142	18.00
1bHHCLS12L36XFTXXXS	\$ 533.00	12	36	36	146	19.00
1bHHCLS12L42XFTXXXS	\$ 565.50	12	42	36	158	22.00
1bHHCLS12L48XFTXXXS	\$ 568.10	12	48	36	180	24.00
1bHHCLS12L54XFTXXXS	\$ 906.10	12	54	36	182	29.00
1bHHCLS12L60XFTXXXS	\$ 948.35	12	60	36	220	31.00
1bHHCLS12L66XFTXXXS	\$ 982.15	12	66	36	253	33.00
1bHHCLS12L72XFTXXXS	\$ 1,005.55	12	72	36	259	36.00
1bHHCLS12L78XFTXXXS	\$ 1,041.95	12	78	36	264	46.00
1bHHCLS12L84XFTXXXS	\$ 1,072.50	12	84	36	275	50.00
1bHHCLS15L30XFTXXXS	\$ 506.35	15	30	36	142	18.00
1bHHCLS15L36XFTXXXS	\$ 533.00	15	36	36	146	19.00
1bHHCLS15L42XFTXXXS	\$ 565.50	15	42	36	158	22.00
1bHHCLS15L48XFTXXXS	\$ 568.10	15	48	36	180	24.00
1bHHCLS15L54XFTXXXS	\$ 906.10	15	54	36	182	29.00
1bHHCLS15L60XFTXXXS	\$ 948.35	15	60	36	220	31.00
1bHHCLS15L66XFTXXXS	\$ 982.15	15	66	36	253	33.00
1bHHCLS15L72XFTXXXS	\$ 1,005.55	15	72	36	259	36.00
1bHHCLS15L78XFTXXXS	\$ 1,041.95	15	78	36	264	46.00
1bHHCLS15L84XFTXXXS	\$ 1,072.50	15	84	36	275	50.00
1bHHCLS12L30XFTXXXS	\$ 543.40	12	30	43	150	22.00
1bHHCLS12L36XFTXXXS	\$ 546.00	12	36	43	154	26.00
1bHHCLS12L42XFTXXXS	\$ 579.80	12	42	43	166	31.00
1bHHCLS12L48XFTXXXS	\$ 717.60	12	48	43	188	35.00
1bHHCLS12L54XFTXXXS	\$ 906.75	12	54	43	194	40.00
1bHHCLS12L60XFTXXXS	\$ 962.65	12	60	43	232	44.00
1bHHCLS12L66XFTXXXS	\$ 1,001.65	12	66	43	265	48.00
1bHHCLS12L72XFTXXXS	\$ 1,023.10	12	72	43	271	53.00
1bHHCLS12L78XFTXXXS	\$ 1,083.55	12	78	43	276	57.00
1bHHCLS12L84XFTXXXS	\$ 1,116.05	12	84	43	287	62.00
1bHHCLS15L30XFTXXXS	\$ 543.40	15	30	43	150	22.00
1bHHCLS15L36XFTXXXS	\$ 546.00	15	36	43	154	26.00
1bHHCLS15L42XFTXXXS	\$ 579.80	15	42	43	166	31.00
1bHHCLS15L48XFTXXXS	\$ 717.60	15	48	43	188	35.00
1bHHCLS15L54XFTXXXS	\$ 906.75	15	54	43	194	40.00
1bHHCLS15L60XFTXXXS	\$ 962.65	15	60	43	232	44.00
1bHHCLS15L66XFTXXXS	\$ 1,001.65	15	66	43	265	48.00
1bHHCLS15L72XFTXXXS	\$ 1,023.10	15	72	43	271	53.00
1bHHCLS15L78XFTXXXS	\$ 1,083.55	15	78	43	276	57.00

Electronic / Electronique

Electronic / Electronique

Grand & Toy

E60PQ-140003/045/PQ

CATEGORY 1B - HUTCHES - LICENCE

1bHHCLS15L84XFTXXS	\$ 1,116.05	15	84	43	287	62.00
--------------------	-------------	----	----	----	-----	-------

REQUIRED SPECIFICATIONS / SPÉCIFICATIONS REQUISES

- Laminate / Stratifié Included/Inclus
 - Handle / Poignée Included/Inclus
-

APPLICATION NOTES / INSTRUCTIONS D'APPLICATION

- Available as Panel Mounted, Panel Upmounted, or Wall Mounted options
- Units are handed, please select left or right configurations as required
- Configurations shown are for reference only and may differ based on size
- **Items marked with a " * " are an extended lead time of 6 weeks**

- Disponible à montage sur panneau, montage sur le dessus du panneau ou montage mural
- Les modules ne sont pas réversibles, sélectionner une configuration gauche ou droite, selon vos besoins
- Les configurations présentées sont à titre de référence seulement et peuvent différer en fonction de la taille
- **Les articles marqués d'un " * " ont un délai de production de 6 semaines**

SAMPLE APPLICATION / EXEMPLE D'APPLICATION

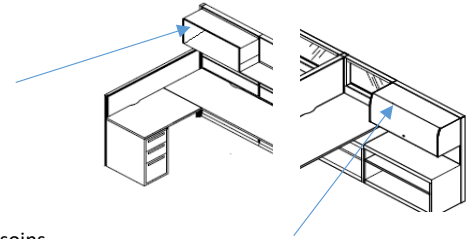

Hutches and Overheads - Overhead Open - Metal

Huches et rangements surélevés - Rangement surélevé ouvert - Métal

Panel mounted / Montage sur panneau

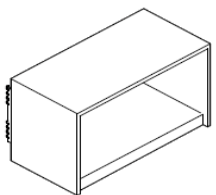
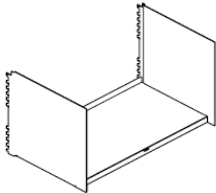

GoCUID / CIUGdc*	Price / Prix	D/P	W/L	H	WT LB	CU
1bHOOAN12L30XXXXXX	\$ 99.45	12	30	14.6	16	0.22
1bHOOAN12L36XXXXXX	\$ 105.30	12	36	14.6	17	0.26
1bHOOAN12L42XXXXXX	\$ 108.55	12	42	14.6	19	0.31
1bHOOAN12L48XXXXXX	\$ 110.50	12	48	14.6	21	0.35
1bHOOAN12L54XXXXXX	\$ 115.05	12	54	14.6	23	0.40
1bHOOAN12L60XXXXXX	\$ 117.65	12	60	14.6	24	0.44
1bHOOAN12L66XXXXXX	\$ 204.75	12	66	14.6	33	0.48
1bHOOAN12L72XXXXXX	\$ 210.60	12	72	14.6	34	0.52
1bHOOAN12L78XXXXXX	\$ 213.85	12	78	14.6	36	0.57
1bHOOAN12L84XXXXXX	\$ 217.10	12	84	14.6	38	0.62
<hr/>						
1bHOOAN15L30XXXXXX	\$ 237.90	15	30	17.55	35	4.86
1bHOOAN15L36XXXXXX	\$ 254.80	15	36	17.55	47	5.83
1bHOOAN15L42XXXXXX	\$ 272.35	15	42	17.55	54	6.81
1bHOOAN15L48XXXXXX	\$ 287.95	15	48	17.55	59	7.78
1bHOOAN15L54XXXXXX	\$ 305.50	15	54	17.55	64	8.75
1bHOOAN15L60XXXXXX	\$ 315.25	15	60	17.55	65	9.72
1bHOOAN15L66XXXXXX	\$ 492.70	15	66	17.55	82	10.69
1bHOOAN15L72XXXXXX	\$ 509.60	15	72	17.55	94	11.66
1bHOOAN15L78XXXXXX	\$ 527.15	15	78	17.55	101	12.64
1bHOOAN15L84XXXXXX	\$ 544.70	15	84	17.55	108	13.62

- Includes panel mounting hardware
- Comprend le matériel pour montage sur panneau

REQUIRED SPECIFICATIONS / SPÉCIFICATIONS REQUISES

- Painted Metal/Métal peint
- Included/Inclus

Upmounted / Montage sur le dessus du panneau

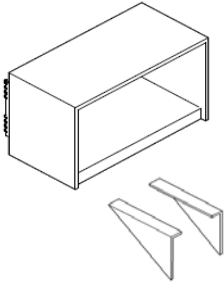

GoCUID / CIUGdC*	Price / Prix	D/P	W/L	H*	WT LB	CU
1bHOOAU15L30XXXXXX	\$ 394.55	15	30	17.55	38	4.95
1bHOOAU15L36XXXXXX	\$ 416.65	15	36	17.55	50	5.92
1bHOOAU15L42XXXXXX	\$ 443.30	15	42	17.55	57	6.90
1bHOOAU15L48XXXXXX	\$ 499.85	15	48	17.55	62	7.87
1bHOOAU15L54XXXXXX	\$ 527.15	15	54	17.55	67	8.84
1bHOOAU15L60XXXXXX	\$ 551.20	15	60	17.55	68	9.81
1bHOOAU15L66XXXXXX	\$ 811.20	15	66	17.55	88	10.87
1bHOOAU15L72XXXXXX	\$ 833.30	15	72	17.55	100	11.84
1bHOOAU15L78XXXXXX	\$ 859.95	15	78	17.55	107	12.82
1bHOOAU15L84XXXXXX	\$ 886.60	15	84	17.55	114	13.80

- Includes panel mounting hardware
- Comprend le matériel pour montage sur panneau

- * Not including upmount hardware
- * Matériel pour montage sur le dessus du panneau non inclus

Wall Mounted / Montage mural

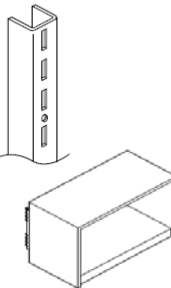
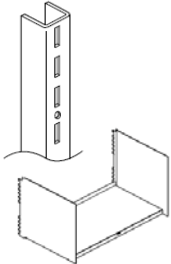

GoCUID / CIUGdC*	Price / Prix	D/P	W/L	H	WT LB	CU
1bHOOAW12L30XXXXXX	\$ 222.95	12	30	14.6	29	0.26
1bHOOAW12L36XXXXXX	\$ 228.80	12	36	14.6	30	0.30
1bHOOAW12L42XXXXXX	\$ 232.05	12	42	14.6	32	0.35
1bHOOAW12L48XXXXXX	\$ 234.00	12	48	14.6	34	0.39
1bHOOAW12L54XXXXXX	\$ 238.55	12	54	14.6	36	0.44
1bHOOAW12L60XXXXXX	\$ 241.15	12	60	14.6	37	0.48
1bHOOAW12L66XXXXXX	\$ 328.25	12	66	14.6	46	0.57
1bHOOAW12L72XXXXXX	\$ 334.10	12	72	14.6	60	0.61
1bHOOAW12L78XXXXXX	\$ 337.35	12	78	14.6	62	0.66
1bHOOAW12L84XXXXXX	\$ 232.05	12	84	14.6	64	0.71
1bHOOAW15L30XXXXXX	\$ 361.40	15	30	17.55	48	4.90
1bHOOAW15L36XXXXXX	\$ 378.30	15	36	17.55	60	5.87
1bHOOAW15L42XXXXXX	\$ 395.85	15	42	17.55	67	6.85
1bHOOAW15L48XXXXXX	\$ 411.45	15	48	17.55	72	7.82
1bHOOAW15L54XXXXXX	\$ 429.00	15	54	17.55	77	8.79
1bHOOAW15L60XXXXXX	\$ 438.75	15	60	17.55	78	9.76
1bHOOAW15L66XXXXXX	\$ 616.20	15	66	17.55	108	10.78
1bHOOAW15L72XXXXXX	\$ 633.10	15	72	17.55	120	11.75
1bHOOAW15L78XXXXXX	\$ 650.65	15	78	17.55	127	12.73
1bHOOAW15L84XXXXXX	\$ 668.20	15	84	17.55	134	13.71

- Includes attachment brackets. Hardware to be supplied based on wall material type. Mounting to weight bearing reinforced studs only.
- Comprend les supports de fixation. Le matériel doit être fourni en fonction du type de matériau du mur. Le module doit être dans un matériau renforcé uniquement.

REQUIRED SPECIFICATIONS / SPÉCIFICATIONS REQUISES

- Painted Metal/Métal peint
- Included/Inclus

Hutches and Overheads - Overhead Closed - Metal

Huches et rangements surélevés - Rangement surélevé ouvert - Métal

Panel Mounted - Flip Top / Montage sur panneau - Rabattable

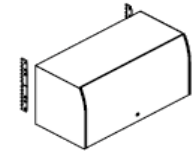
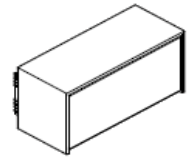
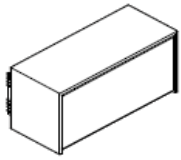

AODA Compliant

Conforme à la norme

AODA

GoCUID / CIUGdC*	Price / Prix	D/P	W/L	H	WT LB	CU
1bHOCAN12L30XFTXXXS	\$ 287.30	12	30	14.6	36	1.31
1bHOCAN12L36XFTXXXS	\$ 314.60	12	36	14.6	43	1.56
1bHOCAN12L42XFTXXXS	\$ 339.95	12	42	14.6	50	1.83
1bHOCAN12L48XFTXXXS	\$ 366.60	12	48	14.6	56	2.09
1bHOCAN12L54XFTXXXS	\$ 391.95	12	54	14.6	63	2.35
1bHOCAN12L60XFTXXXS	\$ 420.55	12	60	14.6	69	2.62
1bHOCAN12L66XFTXXXS	\$ 601.90	12	66	14.6	79	2.87
1bHOCAN12L72XFTXXXS	\$ 629.20	12	72	14.6	86	3.12
1bHOCAN12L78XFTXXXS	\$ 654.55	12	78	14.6	93	3.39
1bHOCAN12L84XFTXXXS	\$ 679.90	12	84	14.6	100	3.66
1bHOCAN15L30XFTXXXS	\$ 375.70	15	30	17.5	49	4.86
1bHOCAN15L36XFTXXXS	\$ 394.55	15	36	17.5	56	5.83
1bHOCAN15L42XFTXXXS	\$ 419.90	15	42	17.5	64	6.81
1bHOCAN15L48XFTXXXS	\$ 446.55	15	48	17.5	75	7.78
1bHOCAN15L54XFTXXXS	\$ 471.25	15	54	17.5	86	8.75
1bHOCAN15L60XFTXXXS	\$ 492.05	15	60	17.5	98	9.72
1bHOCAN15L66XFTXXXS	\$ 770.25	15	66	17.5	105	10.69
1bHOCAN15L72XFTXXXS	\$ 789.10	15	72	17.5	112	11.66
1bHOCAN15L78XFTXXXS	\$ 814.45	15	78	17.5	120	12.64
1bHOCAN15L84XFTXXXS	\$ 839.80	15	84	17.5	128	13.62
1bHOCAN12L30XFTXXXS	\$ 334.10	15	30	14.2	27	5.30
1bHOCAN12L36XFTXXXS	\$ 360.75	15	36	14.2	32	6.30
1bHOCAN12L42XFTXXXS	\$ 385.45	15	42	14.2	37	7.30
1bHOCAN12L48XFTXXXS	\$ 412.10	15	48	14.2	42	8.30
1bHOCAN12L54XFTXXXS	\$ 438.75	15	54	14.2	47	9.30
1bHOCAN12L60XFTXXXS	\$ 464.10	15	60	14.2	53	10.30

- Includes panel mounting hardware
- Comprend le matériel pour montage sur panneau

REQUIRED SPECIFICATIONS / SPÉCIFICATIONS REQUISES

- Painted Metal/Métal peint
- Included/Inclus

Upmounted - Flip Top / Montage sur le dessus du panneau - Rabattable

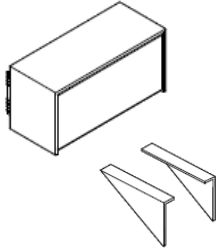

GoCUID / CIUGdC*	Price / Prix	D/P	W/L	H*	WT LB	CU
1bHOCAU15L30XFTXXXS	\$ 532.35	15	30	17.5	55	5.27
1bHOCAU15L36XFTXXXS	\$ 556.40	15	36	17.5	63	6.30
1bHOCAU15L42XFTXXXS	\$ 590.85	15	42	17.5	72	7.34
1bHOCAU15L48XFTXXXS	\$ 658.45	15	48	17.5	84	8.37
1bHOCAU15L54XFTXXXS	\$ 692.90	15	54	17.5	96	9.40
1bHOCAU15L60XFTXXXS	\$ 728.00	15	60	17.5	109	10.44
1bHOCAU15L66XFTXXXS	\$ 1,088.75	15	66	17.5	118	11.57
1bHOCAU15L72XFTXXXS	\$ 1,112.80	15	72	17.5	126	12.59
1bHOCAU15L78XFTXXXS	\$ 1,147.25	15	78	17.5	135	13.63
1bHOCAU15L84XFTXXXS	\$ 1,181.70	15	84	17.5	144	14.68

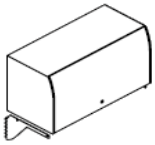

AODA Compliant
Conforme à la norme
AODA

1bHOCAU15L30XFTXXXS	\$ 397.15	15	30	14.2	33	5.30
1bHOCAU15L36XFTXXXS	\$ 416.65	15	36	14.2	40	6.30
1bHOCAU15L42XFTXXXS	\$ 439.40	15	42	14.2	46	7.30
1bHOCAU15L48XFTXXXS	\$ 463.45	15	48	14.2	53	8.30
1bHOCAU15L54XFTXXXS	\$ 486.85	15	54	14.2	59	9.30
1bHOCAU15L60XFTXXXS	\$ 514.15	15	60	14.2	66	10.30

- Includes panel mounting hardware
- Comprend le matériel pour montage sur panneau

* Not including upmount hardware
* Matériel pour montage sur le dessus du panneau non inclus

Wall Mounted - Flip Top / Montage mural - Rabattable

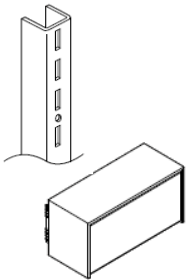

GoCUID / CIUGdC*	Price / Prix	D/P	W/L	H*	WT LB	CU
1bHOCAW15L30XFTXXXS	\$ 499.20	15	30	17.5	62	4.90
1bHOCAW15L36XFTXXXS	\$ 518.05	15	36	17.5	69	5.87
1bHOCAW15L42XFTXXXS	\$ 543.40	15	42	17.5	77	6.85
1bHOCAW15L48XFTXXXS	\$ 570.05	15	48	17.5	88	7.82
1bHOCAW15L54XFTXXXS	\$ 594.75	15	54	17.5	99	8.79
1bHOCAW15L60XFTXXXS	\$ 615.55	15	60	17.5	111	9.76
1bHOCAW15L66XFTXXXS	\$ 893.75	15	66	17.5	131	10.78
1bHOCAW15L72XFTXXXS	\$ 912.60	15	72	17.5	138	11.75
1bHOCAW15L78XFTXXXS	\$ 937.95	15	78	17.5	146	12.73
1bHOCAW15L84XFTXXXS	\$ 963.30	15	84	17.5	154	13.71

- Includes attachment brackets. Hardware to be supplied based on wall material type. Mounting to weight bearing reinforced studs only.
- Comprend les supports de fixation. Le matériel doit être fourni en fonction du type de matériau du mur. Le module doit être dans un matériau renforcé uniquement.

REQUIRED SPECIFICATIONS / SPÉCIFICATIONS REQUISES

- Painted Metal/Métal peint Included/Inclus

Grand & Toy

E60PQ-140003/045/PQ

CATEGORY 1B - OVERHEAD - BOULEVARD

APPLICATION NOTES / INSTRUCTIONS D'APPLICATION

- Available as Panel Mounted or Wall Mounted options
- Units are handed, please select left or right configurations as required
- Configurations shown are for reference only and may differ based on size
- **Items marked with a " * " are an extended lead time of 6 weeks**

- Disponible à montage sur panneau, montage sur le dessus du panneau ou montage mural
- Les modules ne sont pas réversibles, sélectionner une configuration gauche ou droite, selon vos besoins
- Les configurations présentées sont à titre de référence seulement et peuvent différer en fonction de la taille
- **Les articles marqués d'un " * " ont un délai de production de 6 semaines**

SAMPLE APPLICATION / EXEMPLE D'APPLICATION

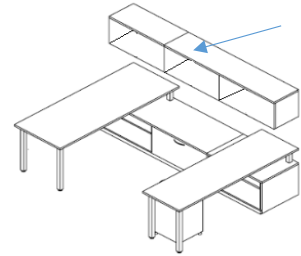

Hutches and Overheads - Overhead Open - Laminate
 Huches et rangements surélevés - Rangement surélevé ouvert - Stratifié

Panel mounted / Montage sur panneau

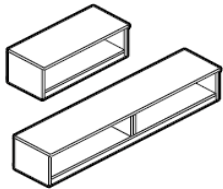

GoCUID / CIUGdC*	Price / Prix	D/P	W/L	H	WT LB	CU
1bHOOLW12L30XXXXXX*	\$ 252.85	12	30	16.75	72	7.00
1bHOOLN12L36XXXXXX*	\$ 268.45	12	36	16.75	80	8.00
1bHOOLN12L42XXXXXX*	\$ 274.95	12	42	16.75	89	9.00
1bHOOLN12L48XXXXXX*	\$ 290.55	12	48	16.75	99	10.00
1bHOOLN12L54XXXXXX*	\$ 505.70	12	54	16.75	108	11.00
1bHOOLN12L60XXXXXX*	\$ 505.70	12	60	16.75	119	12.00
1bHOOLN12L66XXXXXX*	\$ 521.30	12	66	16.75	127	13.00
1bHOOLN12L72XXXXXX*	\$ 536.90	12	72	16.75	141	14.00
1bHOOLN12L78XXXXXX*	\$ 543.40	12	78	16.75	155	15.00
1bHOOLN12L84XXXXXX*	\$ 549.90	12	84	16.75	171	16.00
1bHOOLN15L30XXXXXX	\$ 252.85	15	30	16.75	72	7.00
1bHOOLN15L36XXXXXX	\$ 268.45	15	36	16.75	80	8.00
1bHOOLN15L42XXXXXX	\$ 274.95	15	42	16.75	89	9.00
1bHOOLN15L48XXXXXX	\$ 290.55	15	48	16.75	99	10.00
1bHOOLN15L54XXXXXX*	\$ 505.70	15	54	16.75	108	11.00
1bHOOLN15L60XXXXXX*	\$ 505.70	15	60	16.75	119	12.00
1bHOOLN15L66XXXXXX*	\$ 521.30	15	66	16.75	127	13.00
1bHOOLN15L72XXXXXX*	\$ 536.90	15	72	16.75	141	14.00
1bHOOLN15L78XXXXXX*	\$ 543.40	15	78	16.75	155	15.00
1bHOOLN15L84XXXXXX*	\$ 549.90	15	84	16.75	171	16.00

- Includes panel mounting hardware
- Comprend le matériel pour montage sur panneau.

REQUIRED SPECIFICATIONS / SPÉCIFICATIONS REQUISES

- Laminate / Stratifié
- Included/Inclus

Wall Mounted / Montage mural

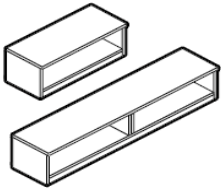

GoCUID / CIUGdC*	Price / Prix	D/P	W/L	H	WT LB	CU
1bHOOLW12L30XXXXXX*	\$ 241.80	12	30	16.75	69	7.00
1bHOOLW12L36XXXXXX*	\$ 258.05	12	36	16.75	78	8.00
1bHOOLW12L42XXXXXX*	\$ 298.35	12	42	16.75	87	9.00
1bHOOLW12L48XXXXXX*	\$ 316.55	12	48	16.75	97	10.00
1bHOOLW12L54XXXXXX*	\$ 341.90	12	54	16.75	106	11.00
1bHOOLW12L60XXXXXX*	\$ 426.40	12	60	16.75	117	12.00
1bHOOLW12L66XXXXXX*	\$ 447.85	12	66	16.75	125	13.00
1bHOOLW12L72XXXXXX*	\$ 467.35	12	72	16.75	139	14.00
1bHOOLW12L78XXXXXX*	\$ 596.70	12	78	16.75	153	15.00
1bHOOLW12L84XXXXXX*	\$ 724.10	12	84	16.75	167	16.00
1bHOOLW15L30XXXXXX	\$ 241.80	15	30	16.75	69	7.00
1bHOOLW15L36XXXXXX	\$ 258.05	15	36	16.75	78	8.00
1bHOOLW15L42XXXXXX	\$ 298.35	15	42	16.75	87	9.00
1bHOOLW15L48XXXXXX	\$ 316.55	15	48	16.75	97	10.00
1bHOOLW15L54XXXXXX	\$ 341.90	15	54	16.75	106	11.00
1bHOOLW15L60XXXXXX	\$ 426.40	15	60	16.75	117	12.00
1bHOOLW15L66XXXXXX	\$ 447.85	15	66	16.75	125	13.00
1bHOOLW15L72XXXXXX	\$ 467.35	15	72	16.75	139	14.00
1bHOOLW15L78XXXXXX*	\$ 596.70	15	78	16.75	153	15.00
1bHOOLW15L84XXXXXX*	\$ 724.10	15	84	16.75	167	16.00

- Includes attachment brackets. Mounting hardware to be supplied based on wall material type. Mounting to weight bearing reinforced studs only.

- Comprend les supports de fixation. Le matériel doit être fourni en fonction du type de matériau du mur. Le module doit être dans un matériau renforcé uniquement.

REQUIRED SPECIFICATIONS / SPÉCIFICATIONS REQUISES

- Laminate / Stratifié Included/Inclus

Hutches and Overheads - Overhead Closed - Laminate
 Huches et rangements surélevés - Rangement surélevé ouvert - Stratifié

Panel Mounted - Single Sliding / Montage sur panneau - Coulissante simple

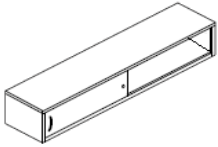

GoCUID / CIUGdC*	Price / Prix	D/P	W/L	H	WT LB	CU
1bHOCLN12L30XSLXXX*	\$ 503.10	12	30	16.75	119	6.00
1bHOCLN12L36XSLXXX*	\$ 503.10	12	36	16.75	123	7.00
1bHOCLN12L42XSLXXX*	\$ 537.55	12	42	16.75	132	8.00
1bHOCLN12L48XSLXXX*	\$ 549.90	12	48	16.75	141	9.00
1bHOCLN12L60XSLXXX*	\$ 1,006.20	12	60	16.75	238	12.00
1bHOCLN12L66XSLXXX*	\$ 1,509.30	12	66	16.75	242	13.00
1bHOCLN12L72XSLXXX*	\$ 1,006.20	12	72	16.75	246	14.00
1bHOCLN12L78XSLXXX*	\$ 1,040.65	12	78	16.75	255	15.00
1bHOCLN12L84XSLXXX*	\$ 1,075.10	12	84	16.75	264	16.00
1bHOCLN15L30XSLXXX*	\$ 503.10	15	30	16.75	119	6.00
1bHOCLN15L36XSLXXX*	\$ 503.10	15	36	16.75	123	7.00
1bHOCLN15L42XSLXXX*	\$ 537.55	15	42	16.75	132	8.00
1bHOCLN15L48XSLXXX*	\$ 549.90	15	48	16.75	141	9.00
1bHOCLN15L60XSLXXX*	\$ 1,006.20	15	60	16.75	238	12.00
1bHOCLN15L66XSLXXX*	\$ 1,509.30	15	66	16.75	242	13.00
1bHOCLN15L72XSLXXX*	\$ 1,006.20	15	72	16.75	246	14.00
1bHOCLN15L78XSLXXX*	\$ 1,040.65	15	78	16.75	255	15.00
1bHOCLN15L84XSLXXX*	\$ 1,075.10	15	84	16.75	264	16.00

- Includes panel mounting hardware
 - Please indicate left or right side locking

- Comprend le matériel pour montage sur panneau
 - Veuillez indiquer le verrouillage du côté gauche ou droit

REQUIRED SPECIFICATIONS / SPÉCIFICATIONS REQUISES

- Laminate / Stratifié Included/Inclus
 - Handle / Poignée Included/Inclus

Panel Mounted - By Pass Sliding / Montage sur panneau - Coulissante à rail d'évitement

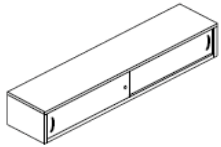

Includes panel mounting hardware

Comprend le matériel pour montage sur panneau

GoCUID / CIUGdC*	Price / Prix	D/P	W/L	H	WT LB	CU
1bHOCLN12L30XBPXXXX*	\$ 503.10	12	30	16.75	119	6.00
1bHOCLN12L36XBPXXXX*	\$ 503.10	12	36	16.75	123	7.00
1bHOCLN12L42XBPXXXX*	\$ 537.55	12	42	16.75	132	8.00
1bHOCLN12L48XBPXXXX*	\$ 549.90	12	48	16.75	141	9.00
1bHOCLN12L60XBPXXXX*	\$ 1,006.20	12	60	16.75	238	12.00
1bHOCLN12L66XBPXXXX*	\$ 1,509.30	12	66	16.75	242	13.00
1bHOCLN12L72XBPXXXX*	\$ 1,006.20	12	72	16.75	246	14.00
1bHOCLN12L78XBPXXXX*	\$ 1,040.65	12	78	16.75	255	15.00
1bHOCLN12L84XBPXXXX*	\$ 1,075.10	12	84	16.75	264	16.00
1bHOCLN15L30XBPXXXX*	\$ 503.10	15	30	16.75	119	6.00
1bHOCLN15L36XBPXXXX*	\$ 503.10	15	36	16.75	123	7.00
1bHOCLN15L42XBPXXXX*	\$ 537.55	15	42	16.75	132	8.00
1bHOCLN15L48XBPXXXX*	\$ 549.90	15	48	16.75	141	9.00
1bHOCLN15L60XBPXXXX*	\$ 1,006.20	15	60	16.75	238	12.00
1bHOCLN15L66XBPXXXX*	\$ 1,509.30	15	66	16.75	242	13.00
1bHOCLN15L72XBPXXXX*	\$ 1,006.20	15	72	16.75	246	14.00
1bHOCLN15L78XBPXXXX*	\$ 1,040.65	15	78	16.75	255	15.00
1bHOCLN15L84XBPXXXX*	\$ 1,075.10	15	84	16.75	264	16.00

- Must select a handle style

- Style de poignée à spécifier

Panel Mounted - Flip Top / Montage sur panneau - Rabattable

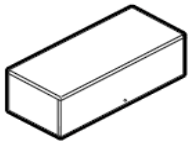

Includes panel mounting hardware

Comprend le matériel pour montage sur panneau

GoCUID / CIUGdC*	Price / Prix	D/P	W/L	H	WT LB	CU
1bHOCLN12L30XFTXXXX*	\$ 396.50	12	30	17.63	119	6.00
1bHOCLN12L36XFTXXXX*	\$ 416.65	12	36	17.63	123	7.00
1bHOCLN12L42XFTXXXX*	\$ 439.40	12	42	17.63	132	8.00
1bHOCLN12L48XFTXXXX*	\$ 462.80	12	48	17.63	141	9.00
1bHOCLN12L60XFTXXXX*	\$ 793.00	12	60	17.63	238	12.00
1bHOCLN12L66XFTXXXX*	\$ 813.15	12	66	17.63	242	13.00
1bHOCLN12L72XFTXXXX*	\$ 833.30	12	72	17.63	246	14.00
1bHOCLN12L78XFTXXXX*	\$ 856.05	12	78	17.63	255	15.00
1bHOCLN12L84XFTXXXX*	\$ 878.80	12	84	17.63	264	16.00
1bHOCLN15L30XFTXXXX*	\$ 396.50	15	30	17.63	119	6.00
1bHOCLN15L36XFTXXXX*	\$ 416.65	15	36	17.63	123	7.00
1bHOCLN15L42XFTXXXX*	\$ 439.40	15	42	17.63	132	8.00
1bHOCLN15L48XFTXXXX*	\$ 462.80	15	48	17.63	141	9.00
1bHOCLN15L60XFTXXXX*	\$ 793.00	15	60	17.63	238	12.00
1bHOCLN15L66XFTXXXX*	\$ 813.15	15	66	17.63	242	13.00
1bHOCLN15L72XFTXXXX*	\$ 833.30	15	72	17.63	246	14.00
1bHOCLN15L78XFTXXXX*	\$ 856.05	15	78	17.63	255	15.00
1bHOCLN15L84XFTXXXX*	\$ 878.80	15	84	17.63	264	16.00

REQUIRED SPECIFICATIONS / SPÉCIFICATIONS REQUISES

- Laminate / Stratifié

Wall Mounted - Single Sliding / Montage mural - Coulissante simple

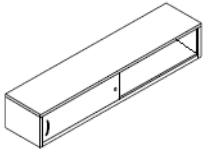

GoCUID / CIUGdC*	Price / Prix	D/P	W/L	H	WT LB	CU
1bHOCLW12L30XSLXXXS*	\$ 477.10	12	30	16.75	120	6.00
1bHOCLW12L36XSLXXXS*	\$ 477.10	12	36	16.75	128	7.00
1bHOCLW12L42XSLXXXS*	\$ 520.65	12	42	16.75	130	8.00
1bHOCLW12L48XSLXXXS*	\$ 540.15	12	48	16.75	132	9.00
1bHOCLW12L54XSLXXXS*	\$ 598.00	12	54	16.75	141	10.00
1bHOCLW12L60XSLXXXS*	\$ 624.65	12	60	16.75	150	11.00
1bHOCLW12L66XSLXXXS*	\$ 666.90	12	66	16.75	159	12.00
1bHOCLW12L72XSLXXXS*	\$ 685.75	12	72	16.75	170	13.00
1bHOCLW12L78XSLXXXS*	\$ 997.75	12	78	16.75	181	14.00
1bHOCLW12L84XSLXXXS*	\$ 1,041.30	12	84	16.75	192	15.00
1bHOCLW15L30XSLXXXS*	\$ 477.10	15	30	16.75	120	6.00
1bHOCLW15L36XSLXXXS*	\$ 477.10	15	36	16.75	128	7.00
1bHOCLW15L42XSLXXXS*	\$ 520.65	15	42	16.75	130	8.00
1bHOCLW15L48XSLXXXS*	\$ 540.15	15	48	16.75	132	9.00
1bHOCLW15L54XSLXXXS*	\$ 598.00	15	54	16.75	141	10.00
1bHOCLW15L60XSLXXXS*	\$ 624.65	15	60	16.75	150	11.00
1bHOCLW15L66XSLXXXS*	\$ 666.90	15	66	16.75	159	12.00
1bHOCLW15L72XSLXXXS*	\$ 685.75	15	72	16.75	170	13.00
1bHOCLW15L78XSLXXXS*	\$ 997.75	15	78	16.75	181	14.00
1bHOCLW15L84XSLXXXS*	\$ 1,041.30	15	84	16.75	192	15.00

- Includes attachment brackets. Mounting hardware to be supplied based on wall material type. Mounting to weight bearing reinforced studs only.

- Comprend les supports de fixation. Le matériel doit être fourni en fonction du type de matériau du mur. Le module doit être dans un matériau renforcé uniquement.

- Please indicate left or right side locking

- Veuillez indiquer le verrouillage du côté gauche ou droit

REQUIRED SPECIFICATIONS / SPÉCIFICATIONS REQUISES

- Laminate / Stratifié

- Handle / Poignée

Wall Mounted - By Pass Sliding / Montage mural - Coulissante à rail d'évitement

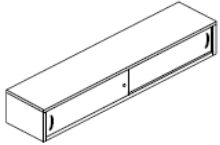

GoCUID / CIUGdC*	Price / Prix	D/P	W/L	H	WT LB	CU
1bHOCLW12L30XBPXXXS*	\$ 477.10	12	30	16.75	120	6.00
1bHOCLW12L36XBPXXXS*	\$ 477.10	12	36	16.75	128	7.00
1bHOCLW12L42XBPXXXS*	\$ 520.65	12	42	16.75	130	8.00
1bHOCLW12L48XBPXXXS*	\$ 540.15	12	48	16.75	132	9.00
1bHOCLW12L54XBPXXXS*	\$ 598.00	12	54	16.75	141	10.00
1bHOCLW12L60XBPXXXS*	\$ 624.65	12	60	16.75	150	11.00
1bHOCLW12L66XBPXXXS*	\$ 666.90	12	66	16.75	159	12.00
1bHOCLW12L72XBPXXXS*	\$ 685.75	12	72	16.75	170	13.00
1bHOCLW12L78XBPXXXS*	\$ 997.75	12	78	16.75	181	14.00
1bHOCLW12L84XBPXXXS*	\$ 1,041.30	12	84	16.75	192	15.00
1bHOCLW15L30XBPXXXS*	\$ 477.10	15	30	16.75	120	6.00
1bHOCLW15L36XBPXXXS	\$ 477.10	15	36	16.75	128	7.00
1bHOCLW15L42XBPXXXS	\$ 520.65	15	42	16.75	130	8.00
1bHOCLW15L48XBPXXXS	\$ 540.15	15	48	16.75	132	9.00
1bHOCLW15L54XBPXXXS	\$ 598.00	15	54	16.75	141	10.00
1bHOCLW15L60XBPXXXS	\$ 624.65	15	60	16.75	150	11.00
1bHOCLW15L66XBPXXXS	\$ 666.90	15	66	16.75	159	12.00
1bHOCLW15L72XBPXXXS	\$ 685.75	15	72	16.75	170	13.00
1bHOCLW15L78XBPXXXS*	\$ 997.75	15	78	16.75	181	14.00
1bHOCLW15L84XBPXXXS*	\$ 1,041.30	15	84	16.75	192	15.00

- Includes attachment brackets. Mounting hardware to be supplied based on wall material type. Mounting to weight bearing reinforced studs only.

- Comprend les supports de fixation. Le matériel doit être fourni en fonction du type de matériau du mur. Le module doit être dans un matériau renforcé uniquement.

REQUIRED SPECIFICATIONS / SPÉCIFICATIONS REQUISES

- Laminate / Stratifié
- Handle / Poignée

Wall Mounted - Flip Top / Montage mural - Rabattable

GoCUID / CIUGdC*	Price / Prix	D/P	W/L	H	WT LB	CU
1bHOCLW12L30FTXXXS*	\$ 364.65	12	30	17.63	94	7.00
1bHOCLW12L36FTXXXS*	\$ 386.75	12	36	17.63	103	8.00
1bHOCLW12L42FTXXXS*	\$ 421.20	12	42	17.63	113	9.00
1bHOCLW12L48FTXXXS*	\$ 442.00	12	48	17.63	123	10.00
1bHOCLW12L54FTXXXS*	\$ 652.60	12	54	17.63	130	11.00
1bHOCLW12L60FTXXXS*	\$ 672.10	12	60	17.63	141	12.00
1bHOCLW12L66FTXXXS*	\$ 711.75	12	66	17.63	151	13.00
1bHOCLW12L72FTXXXS*	\$ 730.60	12	72	17.63	163	14.00
1bHOCLW12L78FTXXXS*	\$ 807.95	12	78	17.63	175	15.00
1bHOCLW12L84FTXXXS*	\$ 842.40	12	84	17.63	187	16.00
1bHOCLW15L30FTXXXS	\$ 364.65	15	30	17.63	94	7.00
1bHOCLW15L36FTXXXS	\$ 386.75	15	36	17.63	103	8.00
1bHOCLW15L42FTXXXS	\$ 421.20	15	42	17.63	113	9.00
1bHOCLW15L48FTXXXS	\$ 442.00	15	48	17.63	123	10.00
1bHOCLW15L54FTXXXS	\$ 652.60	15	54	17.63	130	11.00
1bHOCLW15L60FTXXXS	\$ 672.10	15	60	17.63	141	12.00
1bHOCLW15L66FTXXXS	\$ 711.75	15	66	17.63	151	13.00
1bHOCLW15L72FTXXXS	\$ 730.60	15	72	17.63	163	14.00
1bHOCLW15L78FTXXXS*	\$ 807.95	15	78	17.63	175	15.00
1bHOCLW15L84FTXXXS*	\$ 842.40	15	84	17.63	187	16.00

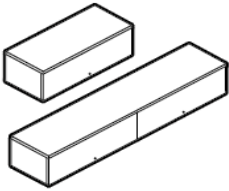

Key / Clé

- Includes attachment brackets. Mounting hardware to be supplied based on wall material type. Mounting to weight bearing reinforced studs only.

- Comprend les supports de fixation. Le matériel doit être fourni en fonction du type de matériau du mur. Le module doit être dans un matériau renforcé uniquement.

REQUIRED SPECIFICATIONS / SPÉCIFICATIONS REQUISES

- Laminate / Stratifié

Wall Mounted - Flip Top / Montage mural - Rabattable

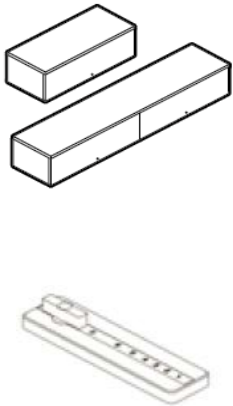

GoCUID / CIUGdC*	Price / Prix	D/P	W/L	H	WT LB	CU
1bHOCLW12L30FTXXXK*	\$ 468.65	12	30	17.63	94	7.00
1bHOCLW12L36FTXXXK*	\$ 490.75	12	36	17.63	103	8.00
1bHOCLW12L42FTXXXK*	\$ 525.20	12	42	17.63	113	9.00
1bHOCLW12L48FTXXXK*	\$ 650.00	12	48	17.63	123	10.00
1bHOCLW12L54FTXXXK*	\$ 860.60	12	54	17.63	130	11.00
1bHOCLW12L60FTXXXK*	\$ 880.10	12	60	17.63	141	12.00
1bHOCLW12L66FTXXXK*	\$ 919.75	12	66	17.63	151	13.00
1bHOCLW12L72FTXXXK*	\$ 730.60	12	72	17.63	163	14.00
1bHOCLW12L78FTXXXK*	\$ 1,015.95	12	78	17.63	175	15.00
1bHOCLW12L84FTXXXK*	\$ 1,050.40	12	84	17.63	187	16.00
1bHOCLW15L30FTXXXK	\$ 468.65	15	30	17.63	94	7.00
1bHOCLW15L36FTXXXK	\$ 490.75	15	36	17.63	103	8.00
1bHOCLW15L42FTXXXK	\$ 525.20	15	42	17.63	113	9.00
1bHOCLW15L48FTXXXK	\$ 650.00	15	48	17.63	123	10.00
1bHOCLW15L54FTXXXK	\$ 860.60	15	54	17.63	130	11.00
1bHOCLW15L60FTXXXK	\$ 880.10	15	60	17.63	141	12.00
1bHOCLW15L66FTXXXK	\$ 919.75	15	66	17.63	151	13.00
1bHOCLW15L72FTXXXK	\$ 730.60	15	72	17.63	163	14.00
1bHOCLW15L78FTXXXK*	\$ 1,015.95	15	78	17.63	175	15.00
1bHOCLW15L84FTXXXK*	\$ 1,050.40	15	84	17.63	187	16.00

Electronic / Électronique

- Includes attachment brackets. Mounting hardware to be supplied based on wall material type. Mounting to weight bearing reinforced studs only.

- Comprend les supports de fixation. Le matériel doit être fourni en fonction du type de matériau du mur. Doit être fixé dans un matériau renforcé uniquement.

REQUIRED SPECIFICATIONS / SPÉCIFICATIONS REQUISES

- Laminate / Stratifié

Grand & Toy

E60PQ-140003/045/PQ

CATEGORY 1B - OVERHEAD - OPEN - LICENCE

APPLICATION NOTES / INSTRUCTIONS D'APPLICATION

- May be used in work space, collaborative, and meeting areas
- Co-ordinates with Licence casegoods and storage
- Peut être utilisé dans les espaces de travail, de collaboration et de réunion
- Se coordonne avec le mobilier Licence

SAMPLE APPLICATION / EXEMPLE D'APPLICATION

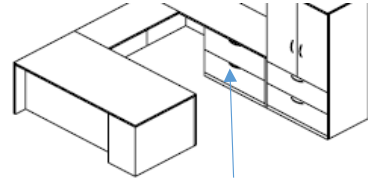

Filing and Storage - Two Drawers Lateral File - Laminate

Classeurs et armoires de rangement - Classeur latéral deux tiroirs - Stratifié



GoCUID / CIUGdC*	Price / Prix	D/P	W/L	H	WT LB	CU	
1bSTDXLGL3018NANKXX	\$ 830.70	18	30	28	99	8.00	Key / Clé
1bSTDXLGL3618NANKXX	\$ 830.70	18	36	28	110	10.00	
1bSTDXLGL3018NAYSXX	\$ 830.70	18	30	28	110	10.00	Electronic / Électronique
1bSTDXLGL3618NAYSXX	\$ 830.70	18	36	28	99	8.00	

REQUIRED SPECIFICATIONS / SPÉCIFICATIONS REQUISES

- Laminate / Stratifié Included/Inclus
- Handle / Poignée Included/Inclus



With Cushion / Avec coussin							
1bSTDXLGL3018NAYKXX	\$ 813.80	18	30	31	99	8.00	Key / Clé
1bSTDXLGL3618NAYKXX	\$ 877.50	18	36	31	110	10.00	
With Cushion / Avec coussin							
1bSTDXLGL3018NAYSXX	\$ 917.80	18	30	31	110	10.00	Electronic / Électronique
1bSTDXLGL3618NAYSXX	\$ 981.50	18	36	31	99	8.00	

REQUIRED SPECIFICATIONS / SPÉCIFICATIONS REQUISES

- Laminate / Stratifié Included/Inclus
- Handle / Poignée Included/Inclus
- Fabric/Tissu Included/Inclus

Grand & Toy

E60PQ-140003/045/PQ

CATEGORY 1B - LATERAL FILES - LICENCE

APPLICATION NOTES / INSTRUCTIONS D'APPLICATION

- May be used in work space, collaborative, and meeting areas
- Panel connection brackets, if required, must be ordered separately.
- Work surface supporting pedestals do not have a top
- Free standing pedestals will not fit under a work surface.
- Peut être utilisé dans les espaces de travail, de collaboration et de réunion
- Les fixations pour raccord à un panneau, si nécessaires, doivent être commandées séparément.
- Les caissons supportant la surface de travail n'ont pas de dessus
- Les caissons autoportants ne peuvent pas être installés sous une surface de travail.

SAMPLE APPLICATION / EXEMPLE D'APPLICATION

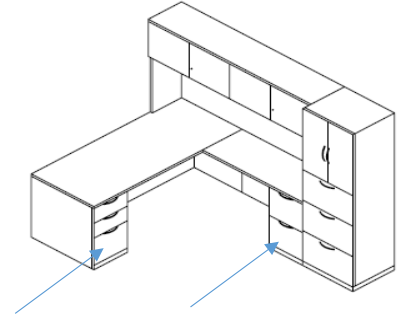

Filing and Storage - Pedestals - Laminate

Classeurs et armoires de rangement - Caissons - Stratifié

Pedestals File-File / Caissons tiroirs classeur-classeur

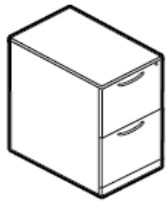

GoCUID / CIUGdC*	Price / Prix	D/P	W/L	H	WT LB	CU	
Freestanding / Autoportant							
1bSPFFLGL1524XXNKXX	\$ 417.30	24	15.5	29	99	8.00	Key / Clé
1bSPFFLGL1530XXNKXX	\$ 451.75	30	15.5	29	110	10.00	

Freestanding / Autoportant							
1bSPFFLGL1524XXNSXX	\$ 521.30	24	15.5	29	99	8.00	Electronic / Électronique
1bSPFFLGL1530XXNSXX	\$ 555.75	30	15.5	29	110	10.00	

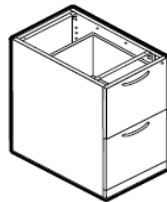

Work Surface Supporting / Support de Surface de Travail							
1bSPFSLGL1524XXNKXX	\$ 395.20	23	15.5	28	94	8.00	Key / Clé
1bSPFSLGL1524XXNSXX	\$ 395.20	24	15.5	28	99	8.00	
1bSPFSLGL1530XXNKXX	\$ 415.35	29	15.5	28	105	10.00	
1bSPFSLGL1530XXNSXX	\$ 415.35	30	15.5	28	110	10.00	

Work Surface Supporting / Support de Surface de Travail							
1bSPFSLGL1524XXNSXX	\$ 499.20	23	15.5	28	94	8.00	Electronic / Électronique
1bSPFSLGL1524XXNSXX	\$ 499.20	24	15.5	28	99	8.00	
1bSPFSLGL1530XXNSXX	\$ 519.35	29	15.5	28	105	10.00	
1bSPFSLGL1530XXNSXX	\$ 519.35	30	15.5	28	110	10.00	



Mobile							
1bSPFMCAL1518XXXKXX	\$ 471.90	23	15.5	28	99	8.00	Key / Clé
1bSPFMCAL1524XXXKXX	\$ 501.80	29	15.5	28	110	10.00	

Mobile							
1bSPFMCAL1518XXXSXX	\$ 575.90	23	15.5	28	99	8.00	Electronic / Électronique
1bSPFMCAL1524XXXSXX	\$ 605.80	29	15.5	28	110	10.00	

REQUIRED SPECIFICATIONS / SPÉCIFICATIONS REQUISES

- Laminate / Stratifié
- Handle / Poignée

Pedestals Box-Box-File / Caissons tiroirs utilité-utilité-classeur

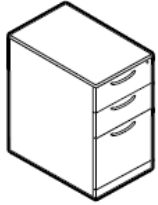

GoCUID / CIUGdC*	Price / Prix	D/P	W/L	H	WT LB	CU
Freestanding / Autoportant						
1bSBBFLGL1524XXNKXX	\$ 460.20	24	15.5	29	99	8.00
1bSBBFLGL1530XXNKXX	\$ 479.05	30	15.5	29	110	10.00

Key / Clé

Freestanding / Autoportant						
1bSBBFLGL1524XXNSXX	\$ 564.20	24	15.5	29	99	8.00
1bSBBFLGL1530XXNSXX	\$ 583.05	30	15.5	29	110	10.00

Electronic /
Électronique

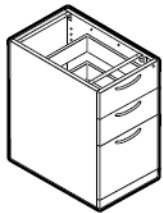

Work Surface Supporting / Support de Surface de Travail						
1bSBBSLGL1524XXNKXX	\$ 423.80	23	15.5	28	94	8.00
1bSBBSLGL1524XXNKXX	\$ 423.80	24	15.5	28	99	8.00
1bSBBSLGL1530XXNKXX	\$ 439.40	29	15.5	28	105	10.00
1bSBBSLGL1530XXNKXX	\$ 439.40	30	15.5	28	110	10.00

Key / Clé

Work Surface Supporting / Support de Surface de Travail						
1bSBBSLGL1524XXNSXX	\$ 527.80	23	15.5	28	94	8.00
1bSBBSLGL1524XXNSXX	\$ 527.80	24	15.5	28	99	8.00
1bSBBSLGL1530XXNSXX	\$ 543.40	29	15.5	28	105	10.00
1bSBBSLGL1530XXNSXX	\$ 543.40	30	15.5	28	110	10.00

Electronic /
Électronique



Mobile						
1bSBBMCAL1518XXXKXX	\$ 553.15	18	15.5	28	99	8.00
1bSBBMCAL1524XXXKXX	\$ 585.00	23	15.5	28	110	10.00

Key / Clé

Mobile						
1bSBBMCAL1518XXXSXX	\$ 657.15	18	15.5	28	99	8.00
1bSBBMCAL1524XXXSXX	\$ 689.00	23	15.5	28	110	10.00

Electronic /
Électronique

REQUIRED SPECIFICATIONS / SPÉCIFICATIONS REQUISES

- Laminate / Stratifié Included/Inclus
- Handle / Poignée Included/Inclus

Pedestals Box-File / Caissons tiroirs utilité/classeur

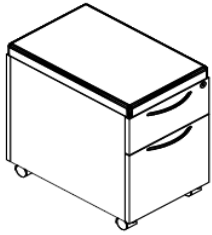

GoCUID / CIUGdC*	Price / Prix	D/P	W/L	H	WT LB	CU
Mobile with Cushion / Mobile avec coussin - GRADE 1						
1bSPBMCAL1518XXYKXX	\$ 503.75	18	15.5	24	101	8.34
1bSPBMCAL1524XXYKXX	\$ 536.90	23	15.5	24	107	8.34
1bSPBMCAL1524XXYKXX	\$ 536.90	24	15.5	24	107	8.34
Mobile with Cushion / Mobile avec coussin - GRADE 2						
1bSPBMCAL1518XXYKXX	\$ 516.75	18	15.5	24	101	8.34
1bSPBMCAL1524XXYKXX	\$ 549.90	23	15.5	24	107	8.34
1bSPBMCAL1524XXYKXX	\$ 549.90	24	15.5	24	107	8.34
Mobile with Cushion / Mobile avec coussin - GRADE 1						
1bSPBMCAL1518XXYKXX	\$ 607.75	18	15.5	24	101	8.34
1bSPBMCAL1524XXYKXX	\$ 640.90	23	15.5	24	107	8.34
1bSPBMCAL1524XXYKXX	\$ 640.90	24	15.5	24	107	8.34
Mobile with Cushion / Mobile avec coussin - GRADE 2						
1bSPBMCAL1518XXYKXX	\$ 620.75	18	15.5	24	101	8.34
1bSPBMCAL1524XXYKXX	\$ 653.90	23	15.5	24	107	8.34
1bSPBMCAL1524XXYKXX	\$ 653.90	24	15.5	24	107	8.34

Key / Clé

Electronic / Électronique

REQUIRED SPECIFICATIONS / SPÉCIFICATIONS REQUISES

- Laminate / Stratifié Included/Inclus
- Handle / Poignée Included/Inclus
- Fabric/Tissu Included/Inclus

Grand & Toy

E60PQ-140003/045/PQ

CATEGORY 1B - PEDESTALS - LICENCE

APPLICATION NOTES / INSTRUCTIONS D'APPLICATION

- May only be used with Category 1A, for all else please use Category 3
- Panel connection brackets if required must be ordered separately.
- Coordinates with other 1200 series metal storage units
- Mobile BBF and FF pedestals or those with E-lock will not fit under a work surface.
- Ne peut être utilisé qu'avec la catégorie 1A. Pour tout le reste, utiliser la catégorie 3.
- Les fixations pour raccord à un panneau, si nécessaires, doivent être commandées séparément.
- Se coordonne aux autres modules de rangement en métal de la gamme 1200
- Les caissons mobiles BBF et FF ou ceux dotés d'un verrouillage électronique ne peuvent pas être placés sous une surface de travail.

SAMPLE APPLICATION / EXEMPLE D'APPLICATION

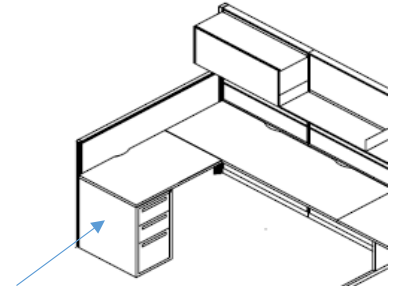

Filing and Storage - Metal - Laminate

Classeurs et armoires de rangement - Caissons - Métal

Pedestals File-File / Caissons tiroirs classeur-classeur

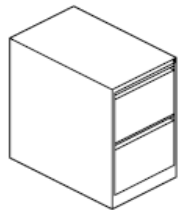

GoCUID / CIUGdC*	Price / Prix	D/P	W/L	H	WT LB	CU	
Freestanding / Autoportant							
1bSPFFLGA1524XXNKXX	\$ 299.00	24	15	27.65	72	7.10	Key / Clé
1bSPFFLGA1530XXNKXX	\$ 360.75	30	15	27.65	88	8.77	

Freestanding / Autoportant							
1bSPFFLGA1524XXNSXX	\$ 590.85	24	15	28.4	74	7.10	Electronic / Électronique
1bSPFFLGA1530XXNSXX	\$ 651.95	30	15	28.4	90	8.77	

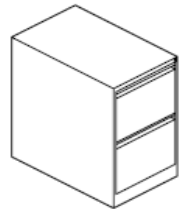

Work Surface Supporting / Support de Surface de Travail							
1bSPFSLGA1524XXNKXX	\$ 299.00	23	15	27.65	72	7.10	Key / Clé
1bSPFSLGA1524XXNKXX	\$ 299.00	24	15	27.65	72	7.10	
1bSPFSLGA1530XXNKXX	\$ 360.75	29	15	27.65	88	8.77	
1bSPFSLGA1530XXNKXX	\$ 360.75	30	15	27.65	88	8.77	

Work Surface Supporting / Support de Surface de Travail							
1bSPFSLGA1524XXNSXX	\$ 590.85	23	15	28.4	74	7.10	Electronic / Électronique
1bSPFSLGA1524XXNSXX	\$ 590.85	24	15	28.4	74	7.10	
1bSPFSLGA1530XXNSXX	\$ 651.95	29	15	28.4	90	8.77	
1bSPFSLGA1530XXNSXX	\$ 651.95	30	15	28.4	90	8.77	

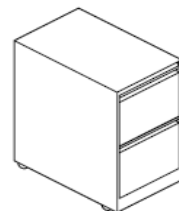

Mobile							
1bSPFMCAA1518XXXKXX	\$ 487.50	18	15	29.25	80	5.47	Key / Clé
1bSPFMCAA1524XXXKXX	\$ 499.85	23	15	29.25	90	6.87	

Mobile							
1bSPFMCAA1518XXSX	\$ 778.70	18	15	31.25	82	5.47	Electronic / Électronique
1bSPFMCAA1524XXSX	\$ 791.05	23	15	31.25	92	6.87	

REQUIRED SPECIFICATIONS / SPÉCIFICATIONS REQUISES

- Metal / Métal
- Included/Inclus

Pedestals Box-Box-File / Caissons tiroirs utilité-utilité-classeur

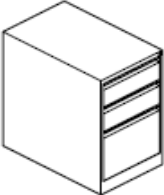
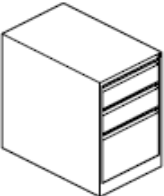
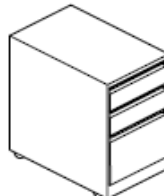
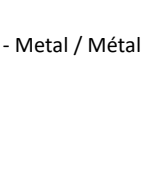
	<i>GoCUID / CIUGdC*</i>	<i>Price / Prix</i>	<i>D/P</i>	<i>W/L</i>	<i>H</i>	<i>WT LB</i>	<i>CU</i>	
	Freestanding / Autoportant							
	1bSBBFLGA1524XXNKXX	\$ 299.00	24	15	27.65	76	7.10	Key / Clé
	1bSBBFLGA1530XXNKXX	\$ 360.75	30	15	27.65	92	8.77	
	Freestanding / Autoportant							
	1bSBBFLGA1524XXNSXX	\$ 590.85	24	15	28.4	78	7.10	Electronic / Électronique
	1bSBBFLGA1530XXNSXX	\$ 651.95	30	15	28.4	94	8.77	
	Work Surface Supporting / Support de Surface de Travail							
	1bSBBSLGA1524XXNKXX	\$ 299.00	23	15	27.65	76	7.10	Key / Clé
	1bSBBSLGA1524XXNKXX	\$ 299.00	24	15	27.65	76	7.10	
	1bSBBSLGA1530XXNKXX	\$ 360.75	29	15	27.65	92	8.77	Key / Clé
	1bSBBSLGA1530XXNKXX	\$ 360.75	30	15	27.65	92	8.77	
Work Surface Supporting / Support de Surface de Travail								
1bSBBSLGA1524XXNSXX	\$ 590.85	23	15	28.4	78	7.10	Electronic / Électronique	
1bSBBSLGA1524XXNSXX	\$ 590.85	24	15	28.4	78	7.10		
1bSBBSLGA1530XXNSXX	\$ 651.95	29	15	28.4	94	8.77	Electronic / Électronique	
1bSBBSLGA1530XXNSXX	\$ 651.95	30	15	28.4	94	8.77		
	Mobile							
	1bSBBMCAA1518XXXKXX	\$ 487.50	18	15	29.25	82	5.47	Key / Clé
	1bSBBMCAA1524XXXKXX	\$ 499.85	23	15	29.25	94	6.87	
Mobile								
1bSBBMCAA1518XXXSXX	\$ 778.70	18	15	31.25	84	5.47	Electronic / Électronique	
1bSBBMCAA1524XXXSXX	\$ 791.05	23	15	31.25	96	6.87		

REQUIRED SPECIFICATIONS / SPÉCIFICATIONS REQUISES

- Metal / Métal Included/Inclus

Pedestals Box-File / Caissons tiroirs utilité-classeur

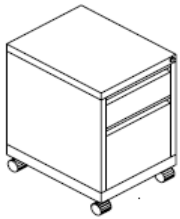

GoCUID / CIUGdC*	Price / Prix	D/P	W/L	H	WT LB	CU
Mobile with Cushion / Mobile avec coussin - GRADE 1						
1bSPBMCAA1518XXYKXX	\$ 568.10	18	15	26.125	50	5.00
1bSPBMCAA1524XXYKXX	\$ 602.88	23	15	26.125	54	6.00
1bSPBMCAA1524XXYKXX	\$ 602.88	24	15	26.125	54	6.00
Mobile with Cushion / Mobile avec coussin - GRADE 2						
1bSPBMCAA1518XXYKXX	\$ 603.20	18	15	26.125	50	5.00
1bSPBMCAA1524XXYKXX	\$ 642.20	23	15	26.125	54	6.00
1bSPBMCAA1524XXYKXX	\$ 642.20	24	15	26.125	54	6.00
Mobile with Cushion / Mobile avec coussin - GRADE 1						
1bSPBMCAA1518XXYSXX	\$ 763.10	18	15	26.875	52	5.00
1bSPBMCAA1524XXYSXX	\$ 797.88	23	15	26.875	56	6.00
1bSPBMCAA1524XXYSXX	\$ 797.88	24	15	26.875	56	6.00
Mobile with Cushion / Mobile avec coussin - GRADE 2						
1bSPBMCAA1518XXYSXX	\$ 798.20	18	15	26.875	52	5.00
1bSPBMCAA1524XXYSXX	\$ 837.20	23	15	26.875	56	6.00
1bSPBMCAA1524XXYSXX	\$ 837.20	24	15	26.875	56	6.00

Key / Clé

Electronic / Électronique

REQUIRED SPECIFICATIONS / SPÉCIFICATIONS REQUISES

- Metal / Métal Included/Inclus
- Fabric / Tissu Included/Inclus

Grand & Toy

E60PQ-140003/045/PQ

CATEGORY 1B - PEDESTALS - 1200 SERIES

APPLICATION NOTES / INSTRUCTIONS D'APPLICATION

- May be used in work space, collaborative, and meeting areas
- Co-ordinates with Licence casegoods and storage
- Open storage may be side or front opening, please specify
- Must specify left or right wardrobe when ordering
- 66"H units match the height of work surface and hutch combinations
- Peut être utilisé dans les espaces de travail, de collaboration et de réunion
- Se coordonne avec le mobilier Licence
- Le rangement ouvert peut être à ouverture latérale ou frontale, spécifier lors de la commande
- Penderie à gauche ou à droite, spécifier lors de la commande
- Les modules 66 po H correspondent à la hauteur totale de la surface de travail et du bahut

SAMPLE APPLICATION / EXEMPLE D'APPLICATION

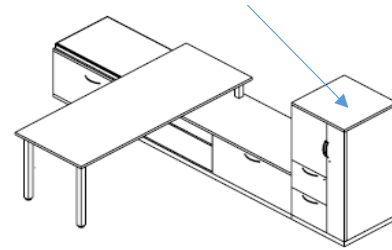

Filing and Storage - Personal Storage Tower - Laminate
 Classeurs et armoires de rangement - Tour de rangement personnel - Stratifié

Open Storage / Rangement ouvert

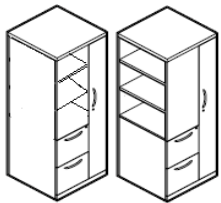

Right / Droite

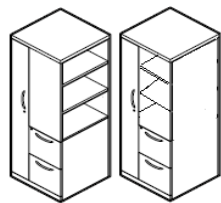

Left / Gauche

GoCUID / CIUGdC*	Price / Prix	D/P	W/L	H	WT LB	CU
1bSPSOLGL242454XKXX	\$ 961.35	24	24	54	243	22.00
1bSPSOLGL242466XKXX	\$ 961.35	24	24	66	268	24.00
1bSPSOLGL302454XKXX	\$ 1,442.03	24	30	54		
1bSPSOLGL302466XKXX	\$ 1,442.03	24	30	66		
1bSPSOLGL243054XKXX	\$ 1,442.03	30	24	54		
1bSPSOLGL243066XKXX	\$ 1,442.03	30	24	66		
1bSPSOLGL303054XKXX	\$ 1,730.43	30	30	54		
1bSPSOLGL303066XKXX	\$ 1,730.43	30	30	66		
1bSPSOLGL242454XSXX	\$ 1,169.35	24	24	54	243	22.00
1bSPSOLGL242466XSXX	\$ 1,169.35	24	24	66	268	24.00
1bSPSOLGL302454XSXX	\$ 1,650.03	24	30	54		
1bSPSOLGL302466XSXX	\$ 1,650.03	24	30	66		
1bSPSOLGL243054XSXX	\$ 1,650.03	30	24	54		
1bSPSOLGL243066XSXX	\$ 1,650.03	30	24	66		
1bSPSOLGL303054XSXX	\$ 1,938.43	30	30	54		
1bSPSOLGL303066XSXX	\$ 1,938.43	30	30	66		

Key / Clé

Electronic / Électronique

* GoCUID is generic to size and shape but not specific to orientation. Please specify accordingly

* GoCUID est générique pour la taille et la forme mais pas spécifique pour l'orientation. Veuillez spécifier en conséquence

REQUIRED SPECIFICATIONS / SPÉCIFICATIONS REQUISES

- Laminate / Stratifié Included/Inclus
- Handle / Poignée Included/Inclus

Closed Storage / Rangement fermé



Right / Droite

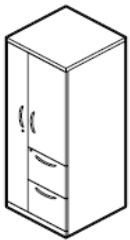

Left / Gauche

GoCUID / CIUGdC*	Price / Prix	D/P	W/L	H	WT LB	CU
1bSPSCLGL242454XKXX	\$ 1,046.50	24	24	54	251	22.00
1bSPSCLGL242466XKXX	\$ 1,046.50	24	24	66	279	24.00
1bSPSCLGL302454XKXX	\$ 1,569.75	24	30	54		
1bSPSCLGL302466XKXX	\$ 1,569.75	24	30	66		
1bSPSCLGL243054XKXX	\$ 1,569.75	30	24	54		
1bSPSCLGL243066XKXX	\$ 1,569.75	30	24	66		
1bSPSCLGL303054XKXX	\$ 1,883.70	30	30	54		
1bSPSCLGL303066XKXX	\$ 1,883.70	30	30	66		
1bSPSCLGL242454XSXX	\$ 1,254.50	24	24	54	251	22.00
1bSPSCLGL242466XSXX	\$ 1,254.50	24	24	66	279	24.00
1bSPSCLGL302454XSXX	\$ 1,777.75	24	30	54		
1bSPSCLGL302466XSXX	\$ 1,777.75	24	30	66		
1bSPSCLGL243054XSXX	\$ 1,777.75	30	24	54		
1bSPSCLGL243066XSXX	\$ 1,777.75	30	24	66		
1bSPSCLGL303054XSXX	\$ 2,091.70	30	30	54		
1bSPSCLGL303066XSXX	\$ 2,091.70	30	30	66		

Key / Clé

Electronic / Électronique

* GoCUID is generic to size and shape but not specific to orientation. Please specify accordingly

* GoCUID est générique pour la taille et la forme mais pas spécifique pour l'orientation. Veuillez spécifier en conséquence

REQUIRED SPECIFICATIONS / SPÉCIFICATIONS REQUISES

- Laminate / Stratifié Included/Inclus
- Handle / Poignée Included/Inclus

Grand & Toy

E60PQ-140003/045/PQ

CATEGORY 1B - PERSONAL STORAGE TOWERS - LICENCE

APPLICATION NOTES / INSTRUCTIONS D'APPLICATION

- May only be used with Category 1A, for all else please use Category 3
- Co-ordinates with Boulevard and other 1200 Series finishes
- Open storage may be side or front opening, please specify
- Must specify left or right wardrobe when ordering
- Ne peut être utilisé qu'avec la catégorie 1A. Pour tout le reste, utiliser la catégorie 3.
- Se coordonne aux autres modules de rangement en métal de la gamme 1200
- Le rangement ouvert peut être à ouverture latérale ou frontale, spécifier lors de la commande
- Penderie à gauche ou à droite, spécifier lors de la commande

SAMPLE APPLICATION / EXEMPLE D'APPLICATION

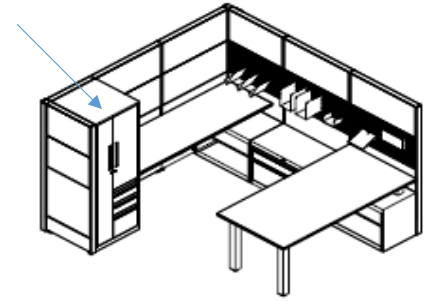

Filing and Storage - Personal Storage Tower - Metal

Classeurs et armoires de rangement - Tour de rangement personnel - Métal

Open Storage File-File / Rangement ouvert + tiroirs classeur-classeur

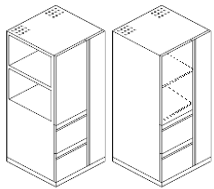

Right / Droite

GoCUID / CIUGdC*	Price / Prix	D/P	W/L	H	WT LB	CU
1bSPSOLGA242454XKXX	\$ 1,184.95	24	24	54	150	20.88
1bSPSOLGA242466XKXX	\$ 1,242.15	24	24	66	158	25.36
1bSPSOLGA243054XKXX	\$ 1,480.70	30	24	54		
1bSPSOLGA243066XKXX	\$ 1,552.85	30	24	66		

Key / Clé

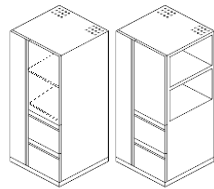

Left / Gauche

1bSPSOLGA242454XSXX	\$ 1,705.60	24	24	54	150	20.88
1bSPSOLGA242466XSXX	\$ 1,762.80	24	24	66	158	25.36
1bSPSOLGA243054XSXX	\$ 2,001.35	30	24	54		
1bSPSOLGA243066XSXX	\$ 2,073.50	30	24	66		

Electronic /
Électronique

* GoCUID is generic to size and shape but not specific to orientation. Please specify accordingly

* GoCUID est générique pour la taille et la forme mais pas spécifique pour l'orientation. Veuillez spécifier en conséquence

REQUIRED SPECIFICATIONS / SPÉCIFICATIONS REQUISES

- Metal / Métal Included/Inclus

Closed Storage File-File / Rangement fermé + tiroirs classeur-classeur

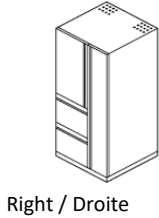

Right / Droite

GoCUID / CIUGdC*	Price / Prix	D/P	W/L	H	WT LB	CU
1bSPSCLGA242454XKXX	\$ 1,261.65	24	24	54	150	20.88
1bSPSCLGA242466XKXX	\$ 1,318.85	24	24	66	160	25.36
1bSPSCLGA243054XKXX	\$ 1,576.90	30	24	54		
1bSPSCLGA243066XKXX	\$ 1,648.40	30	24	66		

Key / Clé

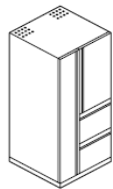

Left / Gauche

1bSPSCLGA242454XSXX	\$ 1,782.30	24	24	54	150	20.88
1bSPSCLGA242466XSXX	\$ 1,839.50	24	24	66	160	25.36
1bSPSCLGA243054XSXX	\$ 2,097.55	30	24	54		
1bSPSCLGA243066XSXX	\$ 2,169.05	30	24	66		

Electronic /
Électronique

* GoCUID is generic to size and shape but not specific to orientation. Please specify accordingly

* GoCUID est générique pour la taille et la forme mais pas spécifique pour l'orientation. Veuillez spécifier en conséquence

REQUIRED SPECIFICATIONS / SPÉCIFICATIONS REQUISES

- Metal / Métal

Included/Inclus

Grand & Toy

E60PQ-140003/045/PQ

CATEGORY 1B - PERSONAL STORAGE TOWERS - 1200 SERIES

APPLICATION NOTES / INSTRUCTIONS D'APPLICATION

- May be used in work space, collaborative, and meeting areas
- Co-ordinates with Licence casegoods and storage
- High bookcases align with the height of work surface and hutch combination
- Peut être utilisé dans les espaces de travail, de collaboration et de réunion
- Se coordonne avec le mobilier Licence
- Les bibliothèques hautes s'alignent avec la hauteur totale de la surface de travail et de la huche

Filing and Storage - Bookcases - Laminate

Classeurs et armoires de rangement - Bibliothèque - Stratifié

Low Height / Basse

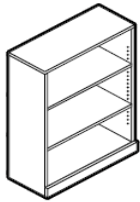

GoCUID / CIUGdC*	Price / Prix	D/P	W/L	H	WT LB	CU
1bSBCXLGL2412SMXXXX	\$ 313.95	12	24	40	149	6.00
1bSBCXLGL3012SMXXXX	\$ 313.95	12	30	40	160	9.00
1bSBCXLGL3612SMXXXX	\$ 344.50	12	36	40	171	12.00
1bSBCXLGL2415SMXXXX	\$ 344.50	15	24	40	151	12.00
1bSBCXLGL3015SMXXXX	\$ 390.65	15	30	40	162	15.00
1bSBCXLGL3615SMXXXX	\$ 440.05	15	36	40	173	18.00

Medium Height / Moyenne

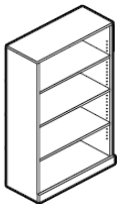

GoCUID / CIUGdC*	Price / Prix	D/P	W/L	H	WT LB	CU
1bSBCXLGL2412MEXXXX	\$ 374.40	12	24	54	167	12.00
1bSBCXLGL3012MEXXXX	\$ 374.40	12	30	54	178	13.00
1bSBCXLGL3612MEXXXX	\$ 420.55	12	36	54	189	15.00
1bSBCXLGL2415MEXXXX	\$ 477.10	15	24	54	169	16.00
1bSBCXLGL3015MEXXXX	\$ 477.10	15	30	54	180	19.00
1bSBCXLGL3615MEXXXX	\$ 521.30	15	36	54	191	22.00

High Height / Haute

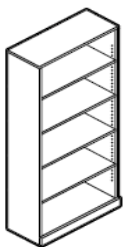

GoCUID / CIUGdC*	Price / Prix	D/P	W/L	H	WT LB	CU
1bSBCXLGL2412HIXXXX	\$ 451.75	12	24	66	180	11.00
1bSBCXLGL3012HIXXXX	\$ 451.75	12	30	66	193	15.00
1bSBCXLGL3612HIXXXX	\$ 492.70	12	36	66	204	19.00
1bSBCXLGL2415HIXXXX	\$ 534.95	15	24	66	182	11.00
1bSBCXLGL3015HIXXXX	\$ 534.95	15	30	66	195	15.00
1bSBCXLGL3615HIXXXX	\$ 598.65	15	36	66	206	19.00

REQUIRED SPECIFICATIONS / SPÉCIFICATIONS REQUISES

- Laminate finish / Stratifié

Grand & Toy

E60PQ-140003/045/PQ

CATEGORY 1B - BOOKCASES - LICENCE

APPLICATION NOTES / INSTRUCTIONS D'APPLICATION

- May be used in work space, collaborative, and meeting areas
- Co-ordinates with Licence casegoods and storage
- High bookcases align with the height of work surface and hutch combination
- Peut être utilisé dans les espaces de travail, de collaboration et de réunion
- Se coordonne avec le mobilier Licence
- Les bibliothèques hautes s'alignent avec la hauteur totale de la surface de travail et de la huche

Filing and Storage - Bookcases - Metal
 Classeurs et armoires de rangement - Bibliothèque - Métal

Height : Low / Basse

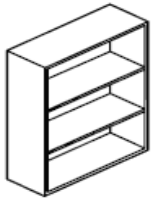

GoCUID / CIUGdC*	Price / Prix	D/P	W/L	H	WT LB	CU
1bSBCXLGA3012SMXXXX	\$ 148.85	12	30	40	53	11.21
1bSBCXLGA3612SMXXXX	\$ 159.90	12	36	40	61	13.20

Height : Medium / Moyenne

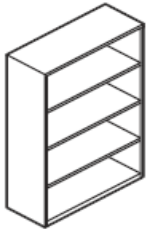

GoCUID / CIUGdC*	Price / Prix	D/P	W/L	H	WT LB	CU
1bSBCXLGA3012MEXXXX	\$ 202.80	12	30	54	67	14.58
1bSBCXLGA3612MEXXXX	\$ 216.45	12	36	54	77	17.20

Height : High / Haute

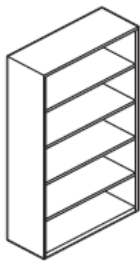

GoCUID / CIUGdC*	Price / Prix	D/P	W/L	H	WT LB	CU
1bSBCXLGA3012HIXXXX	\$ 267.80	12	30	66	81	17.95
1bSBCXLGA3612HIXXXX	\$ 269.75	12	36	66	92	21.20

REQUIRED SPECIFICATIONS / SPÉCIFICATIONS REQUISES

- Metal / Métal Included/Inclus

Grand & Toy

E60PQ-140003/045/PQ

CATEGORY 1B - BOOKCASES - 9100 SERIES

