

A Quick Reference Guide to Grand & Toy

Freestanding Height Adjustable
Work Surfaces Category 2

EXCLUSIVELY FOR:
Federal Government

Workspaces Supply Arrangement
SA # E60PQ-140003/045/PQ

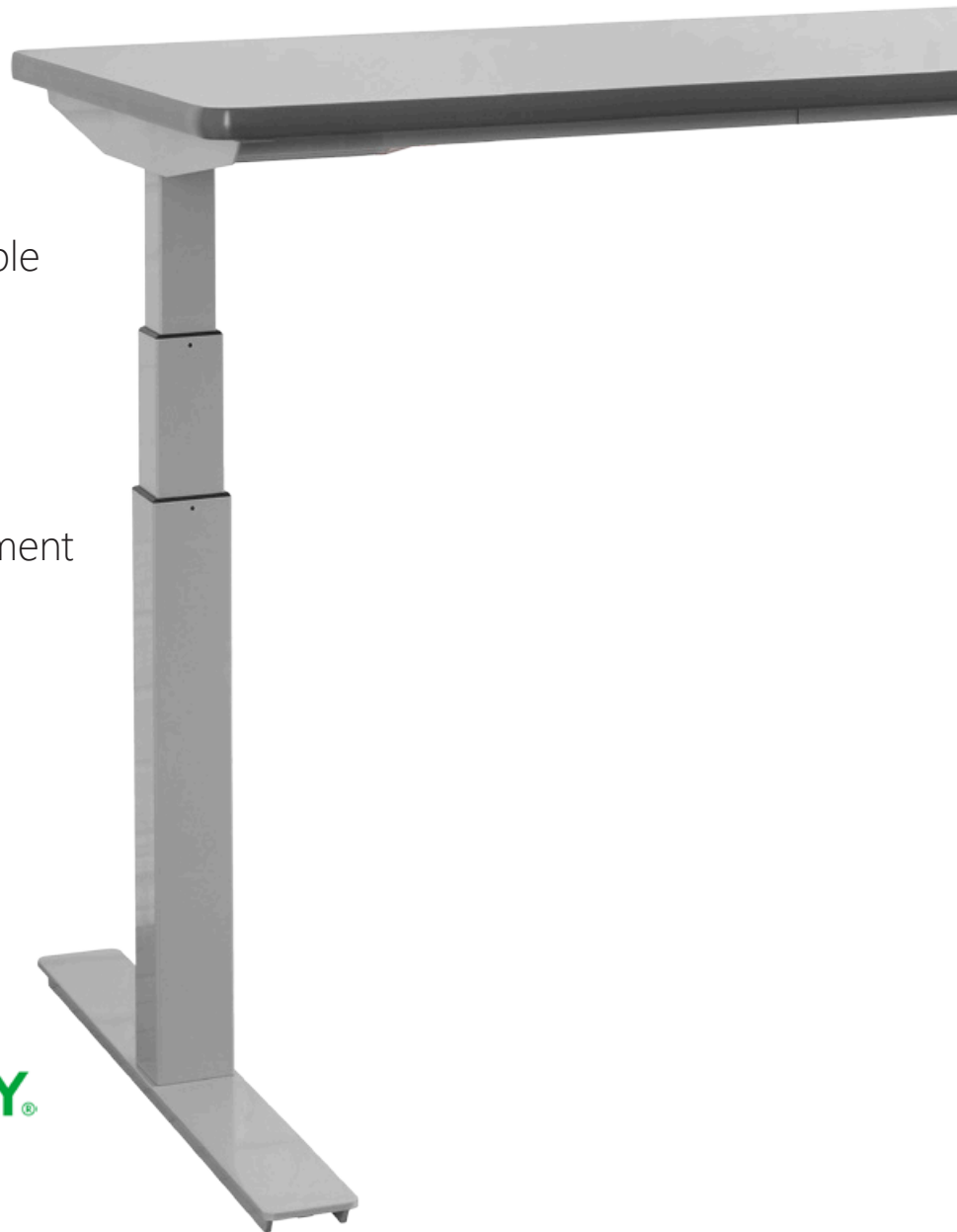

Table of contents

- 2 Features to look for in a Freestanding Height Adjustable Work Surface
- 3 How to order an upCentric® Freestanding Height Adjustable Work Surface
- 4 Ordering chart
- 5 Frame specifications
- 9 Tabletop specifications
- 9 Vertical Wire Management
- 10 Height adjustment handset
- 10 3" Grommet Hole locations
- 11 Power and wire management accessory options
- 14 Acoustic privacy panels
- 17 Warranty



Features to look for in a Freestanding Height Adjustable Work Surface

Height adjustable tables have become a popular choice in today's workspaces. With so many brands and options to choose from, a table that satisfies your clients' needs can be challenging – we are here to help!

The upCentric® allows users to easily adjust their work surface to the appropriate height for their unique seated posture, and alternate between seated and standing positions throughout the work day. This adjustability reduces aches, pains, stress and tension, and improves circulation throughout the body. Moving the table is intuitive with the easy-to-use up/down control with four position memory. The quiet motors housed in each of the table's legs ensure a quick, smooth transition in positions. The durable open frame design provides optimal knee clearance and space for storage.

Here are some key features to look for when buying a Freestanding Height Adjustable Work Surface.

① Motors in every leg:

Ensures a smooth, quiet and quick transition. The upCentric features motors made by TiMOTION® and takes just 17 seconds to travel the 26.5" range from the lowest to highest height.

② Quick and easy installation:

The upCentric is one of the simplest height adjustable tables to assemble. Printed and video instructions make assembling the upCentric easy enough to complete in approximately 15 minutes.

③ Low power draw:

The upCentric is one of the most efficient electric height adjustable tables on the market, minimizing operating and stand-by power draw to help you save money.

④ 1.8 m hard-usage power cable:

All upCentric tables are equipped with a 70 7/8" or 1.8 m hard-usage cable, as required by CSA 22.2 #203.

⑤ Vertical wire management included:

Assists with the organization and presentation of cables and wires in each workstation.

⑥ Low sound level:

The upCentric is one of the quietest height adjustable tables on the market, at 39dB.



upCentric[®]
ergocentric.com

powered by / propulsé par / con tecnologia

TiMOTION[®]
MOTION WITH INTELLIGENCE



How to order an upCentric® Freestanding Height Adjustable Work Surface

Step 1:

Choose a Height Adjustable Work Surface
See page 4
e.g. *CGSA-2LS-24X48* or *CGSAMOD-3L-120-54X24*

SIZE	GOUID	TABLE	FRAME COLOURS	LAMINATE FINISH
Rectangular Tables				
24" x 30"	2WSSREXXL24L30BELXX	CGSAMOD-2LS-24X30	Codes for finishes see page 9	
24" x 36"	2WSSREXXL24L36BELXX	CGSAMOD-2LS-24X36		
24" x 42"	2WSSREXXL24L42BELXX	CGSA-2LS-24X42		
24" x 48"	2WSSREXXL24L48BELXX	CGSA-2LS-24X48		
24" x 54"	2WSSREXXL24L54BELXX	CGSA-2LS-24X54		

Step 2:

Select frame colour
e.g. *Silver*

Frame finish options



Silver

Black

White*

* White is not available on modular frames.

Step 3:

Select laminate finish
e.g. *Dove Grey*

OPTIONS	
HPL-High Pressure Laminate	
Kensington Maple	21
Natural Pear	22
Wild Cherry	23
Figured Mahogany	24
Cocobala	25
Asian Night	26
Black	27
Designer White	28
Dove Grey	29
North Sea	30
Graphite	31
Natural Almond	32
Vapor Strandz	33
Studio Teak	34
Walnut Heights	35
Xanadu	36

Step 4:

Choose power and wire management accessories†
See pages 11-13

† The cumulative sum of all power and wire management accessories may not exceed 30% of the Height Adjustable Work Surface purchase price.
e.g. A *CGSA-2L-30X72* table has a ceiling price of \$901.76 – you may add up to \$270.53 (30% of \$901.76) worth of accessories to that table.





Freestanding Height Adjustable Work Surface ordering chart

SIZE	GOCUID	TABLE	FRAME COLOURS	LAMINATE FINISH	GROMMET HOLE(S)	CEILING PRICE
------	--------	-------	---------------	-----------------	-----------------	---------------

Rectangular Tables

24" x 30"	2WSSREXXL24L30BELXX	CGSAMOD-2LS-24X30	Codes for finishes see page 9		3GHC	\$877.60
24" x 36"	2WSSREXXL24L36BELXX	CGSAMOD-2LS-24X36			3GHC	\$877.60
24" x 42"	2WSSREXXL24L42BELXX	CGSA-2LS-24X42			3GHC	\$774.46
24" x 48"	2WSSREXXL24L48BELXX	CGSA-2LS-24X48			3GHC	\$790.37
24" x 54"	2WSSREXXL24L54BELXX	CGSA-2LS-24X54			3GHL & 3GHR	\$806.28
24" x 60"	2WSSREXXL24L60BELXX	CGSA-2LS-24X60			3GHL & 3GHR	\$822.20
24" x 66"	2WSSREXXL24L66BELXX	CGSA-2LS-24X66			3GHL & 3GHR	\$838.11
24" x 72"	2WSSREXXL24L72BELXX	CGSA-2LS-24X72			3GHL & 3GHR	\$854.02
30" x 30"	2WSSREXXL30L30BELXX	CGSAMOD-2L-30X30			3GHC	\$905.89
30" x 36"	2WSSREXXL30L36BELXX	CGSAMOD-2L-30X36			3GHC	\$905.89
30" x 42"	2WSSREXXL30L42BELXX	CGSAMOD-2L-30X42			3GHC	\$905.89
30" x 48"	2WSSREXXL30L48BELXX	CGSA-2L-30X48			3GHC	\$822.20
30" x 54"	2WSSREXXL30L54BELXX	CGSA-2L-30X54			3GHL & 3GHR	\$842.24
30" x 60"	2WSSREXXL30L60BELXX	CGSA-2L-30X60			3GHL & 3GHR	\$862.77
30" x 66"	2WSSREXXL30L66BELXX	CGSA-2L-30X66			3GHL & 3GHR	\$882.31
30" x 72"	2WSSREXXL30L72BELXX	CGSA-2L-30X72			3GHL & 3GHR	\$901.76
36" x 30"	2WSSREXXL30L30BELXX	CGSAMOD-2L-36X30			3GHC	\$993.71
36" x 36"	2WSSREXXL36L36BELXX	CGSAMOD-2L-36X36			3GHC	\$993.71
36" x 42"	2WSSREXXL36L42BELXX	CGSAMOD-2L-36X42			3GHC	\$993.71
36" x 48"	2WSSREXXL36L48BELXX	CGSA-2L-36X48			3GHC	\$890.56
36" x 54"	2WSSREXXL36L54BELXX	CGSA-2L-36X54			3GHL & 3GHR	\$962.47
36" x 60"	2WSSREXXL36L60BELXX	CGSA-2L-36X60			3GHL & 3GHR	\$1,019.64
36" x 66"	2WSSREXXL36L66BELXX	CGSA-2L-36X66			3GHL & 3GHR	\$1,042.04
36" x 72"	2WSSREXXL36L72BELXX	CGSA-2L-36X72			3GHL & 3GHR	\$1,062.08

120° Wing Tables

36" x 24"	2WSSDEXXL24L36BELXX	CGSAMOD-3L-120-36X24			3GHL & 3GHR	\$1,558.93
36" x 30"	2WSSDEXXL30L36BELXX	CGSAMOD-3L-120-36X30			3GHL & 3GHR	\$1,558.93
42" x 24"	2WSSDEXXL24L42BELXX	CGSAMOD-3L-120-42X24			3GHL & 3GHR	\$1,582.51
42" x 30"	2WSSDEXXL30L42BELXX	CGSAMOD-3L-120-42X30			3GHL & 3GHR	\$1,582.51
48" x 24"	2WSSDEXXL24L48BELXX	CGSAMOD-3L-120-48X24			3GHL & 3GHR	\$1,567.77
54" x 24"	2WSSDEXXL24L54BELXX	CGSAMOD-3L-120-54X24			3GHL & 3GHR	\$1,567.77



Frame specifications



2-Leg Modular Frame in Silver



2-Leg Frame in White



3-Leg Modular Frame in Black



Frame specifications

Rectangular Height Adjustable Work Surfaces, 30" wide - 42" wide

2-Leg Modular Frames
[CGSAMOD-2LS & CGSA MOD-2L]
Top Down View

Frame & Rectangular Tabletop

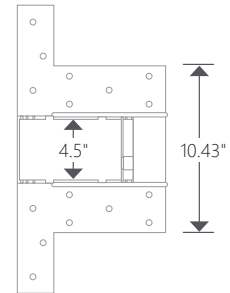
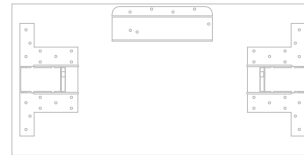

2-Leg Modular Frames
[CGSAMOD-2LS & CGSAMOD-2L]
Height Range

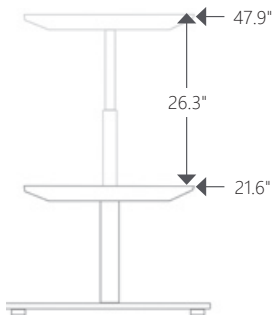

2-Leg Modular Frames
[CGSAMOD-2LS & CGSAMOD-2L]
Front View



2-Leg Small Modular
[CGSAMOD-2LS]
Side View

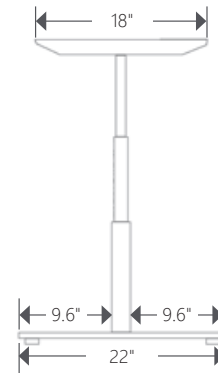

2-Leg Modular
[CGSAMOD-2L]
Side View

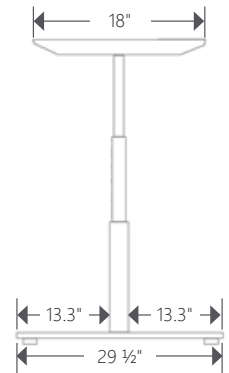

Specifications

	2-LEG SMALL MODULAR FRAME	2-LEG MODULAR FRAME
Frame code	CGSAMOD-2LS	CGSAMOD-2L
Height range	22.6" - 48.9"	22.6" - 48.9"
Width range	Varies	Varies
Depth of frame base	22"	29 1/2"
Depth of frame bracket	18"	18"
Assembly time	Varies	Varies
Travel speed	1.6" per second	1.6" per second
Digital memory control buttons	4 position memory	4 position memory
Weight capacity*	250 lbs	250 lbs
Electric TiMOTION® motors	2 motors	2 motors
Max power draw	30 W	30 W
Standby power draw	0.06 W	0.06 W
Sound level	39 dB	39 dB
Accommodates tabletop sizes	24"x30" up to 24"x36"	30"x30" up to 36"x42"
Frame finish	Silver, black	Silver, black
Power cord length	70 7/8" or 1.8 m	70 7/8" or 1.8 m
Certification	BIFMA E3 LEVEL 2 BIFMA G1 BIFMA X5.5 CSA C22.2 NO. 14 CSA C22.2 NO. 68-09 CSA C22.2 NO. 203 GREENGUARD® GOLD	

* Weight capacity does not include the weight of the tabletop.



Frame specifications

Rectangular Height Adjustable Work Surfaces, 48" wide - 72" wide

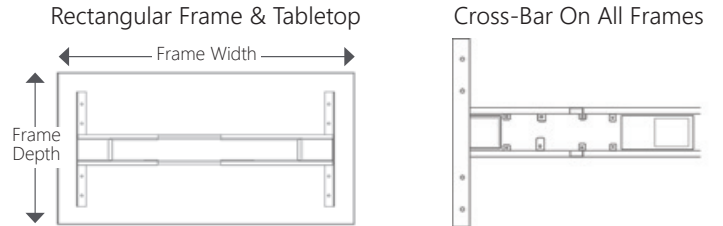

2-Leg Small and 2-Leg Frame [CGSA-2LS & CGSA-2L] Height Range

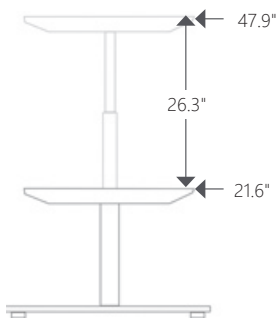

2-Leg Small and 2-Leg Frame [CGSA-2LS & CGSA-2L] Front View

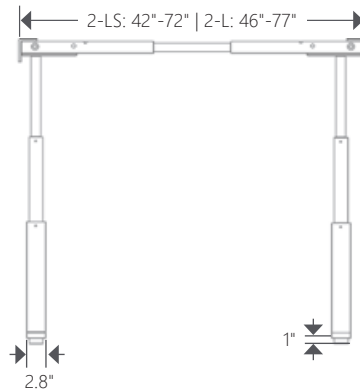

2-Leg Small Frame [CGSA-2LS] Side View

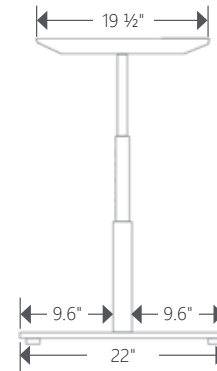

2-Leg Frame [CGSA-2L] Side View

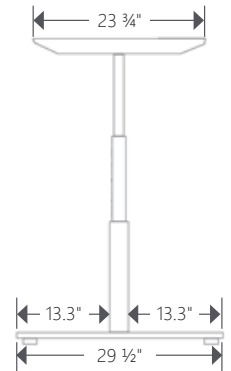

Specifications

	2-LEG SMALL FRAME	2-LEG FRAME
Frame code	CGSA-2LS	CGSA-2L
Height range	22.6" - 48.9"	22.6" - 48.9"
Width range	42" - 72"	46" - 77"
Depth of frame base	22"	29 1/2"
Depth of frame bracket	19 1/2"	23 3/4"
Assembly time	5 - 10 minutes	5 - 10 minutes
Travel speed	1.6" per second	1.6" per second
Digital memory control buttons	4 position memory	4 position memory
Weight capacity*	220 lbs	300 lbs
Electric TiMOTION® motors	2 motors	2 motors
Max power draw	30 W	30 W
Standby power draw	0.06 W	0.06 W
Sound level	39 dB	39 dB
Accommodates tabletop sizes	24"x42" up to 24"x72"	30"x48" up to 36"x72"
Frame finish	White, silver, black	White, silver, black
Power cord length	70 7/8" or 1.8 m	70 7/8" or 1.8 m
Certification	BIFMA E3 LEVEL 2 BIFMA G1 BIFMA X5.5 CSA C22.2 NO. 14 CSA C22.2 NO. 68-09 CSA C22.2 NO. 203 GREENGUARD® GOLD	

* Weight capacity does not include the weight of the tabletop.



Frame specifications

120° Wing Shape
Height Adjustable Work Surfaces

Frame & 120° Tabletop

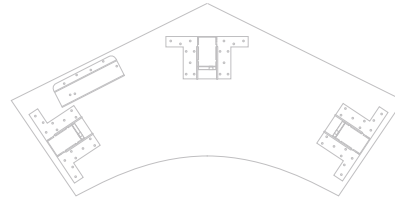

3-Leg Modular Frames
Top Down View

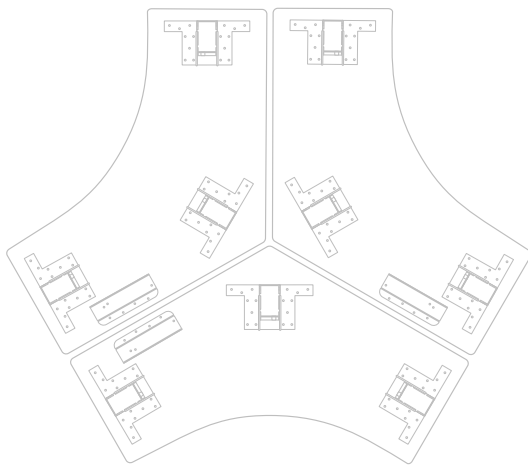
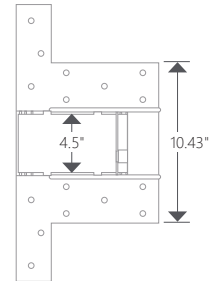

3-Leg Modular Frame
[CGSAMOD-3L-120]
Height Range

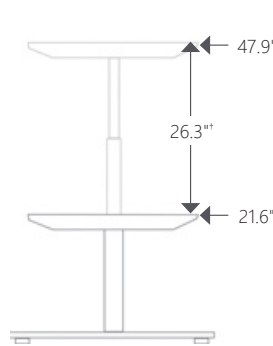

3-Leg Modular Frame
[CGSAMOD-3L-120]
Front View*

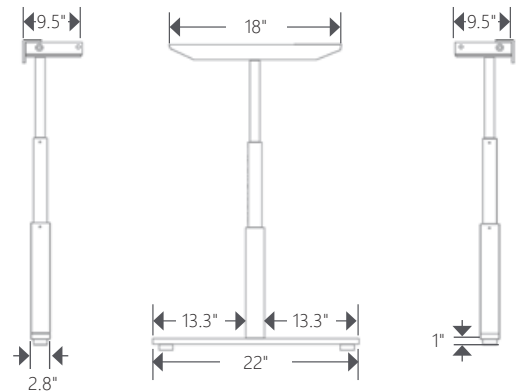

Specifications

	3-LEG MODULAR FRAME
Frame code	CGSAMOD-3L-120
Height range	22.6" - 48.9"
Width range	Varies
Depth of frame base	22"
Depth of frame bracket	18"
Assembly time	25 - 40 minutes
Travel speed	1.6" per second
Digital memory control buttons	4 position memory
Weight capacity*	400 lbs
Electric TiMOTION® motors	3 motors
Max power draw	30 W
Standby power draw	0.06 W
Sound level	39 dB
Accommodates tabletop sizes	24"x36" up to 24"x54" OR 30"x36" up to 30"x42"
Frame finish	Silver, black
Power cord length	70 7/8" or 1.8 m
Certification	BIFMA E3 LEVEL 2 BIFMA G1 BIFMA X5.5 CSA C22.2 NO. 14 CSA C22.2 NO. 68-09 CSA C22.2 NO. 203 GREENGUARD® GOLD

* Weight capacity does not include the weight of the tabletop.
* Representation of the legs at 0° and 90° respectively.



Tabletop specifications

- Tabletops are constructed using 1" thick FSC-Certified 45 lbs particle board, High Pressure Laminate and 3 mm PVC-free edge band.
- All tabletops are made to exact printed dimensions.
e.g. CGSA-2L-30X60 Height Adjustable Work Surface will measure to exactly 30" x 60", +/- 0.25" tolerance.

Edge Band

High Pressure Laminates [HPL]

- High Pressure Laminate tabletops are 1 1/16" thick, and are available in 16 finishes
- 10 day lead time

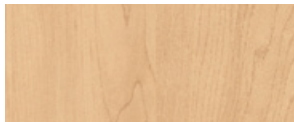

Kensington Maple 21



Natural Pear 22



Wild Cherry 23



Figured Mahogany 24



Cocobala 25



Asian Night 26

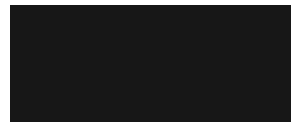

Black 27

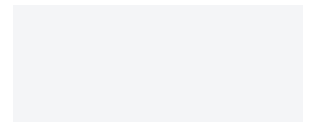

Designer White 28



Dove Grey 29



North Sea 30



Graphite 31

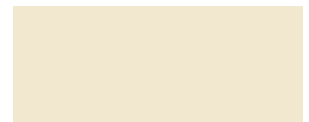

Natural Almond 32

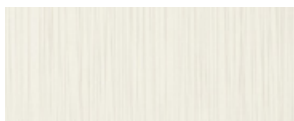

Vapor Strandz 33



Studio Teak 34



Walnut Heights 35

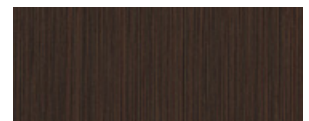

Xanadu 36

Vertical wire management

- A vertical wire management slinky is included with every Height Adjustable Work Surface.
- The Vertical Wire Management Slinky attaches to the underside of your Work Surface, and allows all wires and cables to run from your work surface to the floor cleanly.





Height adjustment handset



Digital height display with 4 programmable memory positions

- Up/down control switch with digital read-out
- Four programmable memory settings with minimum and maximum height

Safety feature

- Standard anti-collision safety features stops table in event of collision with immovable object
- Optional highly sensitive anti-collision sensor available

3" Grommet hole locations

- 3" grommet hole with plastic grommet cover
- Positioned 4" from each edge to center of hole
- Tables with a width of 48" or smaller must have at least one hole (3GHC standard)
- Tables with a width of 54" or larger must have at least two holes (3GHL & 3GHR standard)
- 120° Wing tables must have at least two holes (3GHL & 3GHR standard)
- Grommet holes may be added or moved from the standard positions, but may not be removed

Standard locations

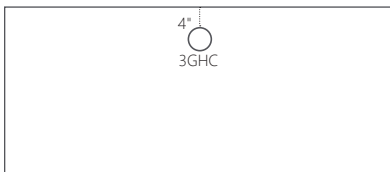

48" wide and smaller



54" wide and larger



120° tables

Options

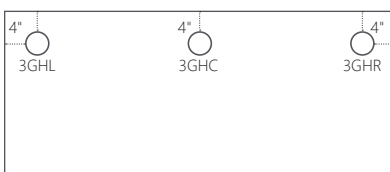



Power and wire management accessory options

- Power and wire management accessories can be added to any SA Freestanding Height Adjustable Work Surface.
- The cumulative sum of all power and wire management accessories may not exceed 30% of the Height Adjustable Work Surface purchase price. *e.g. A CGSA-2L-30X72 table has a ceiling price of \$901.76 – you may add up to \$270.53 (30% of \$901.76) worth of accessories to that table.*

3" Power dock

- The 3" grommet power and pop-up dock can be used in anywhere that needs an easy access AC power and 5V DC 2.1 A USB charger. Simply bore a 3" hole for installation or replace a 3" grommet with any of the Dock-200 Series. The simple touch of a finger tip will release the spring-loaded lid of the 3" grommet and it will gently open up to reveal an AC outlet and USB charger.

Outlets	Code	Colour	List Price
<ul style="list-style-type: none"> • 2 grounded AC outlet 15A rating • 10' 14 AWG power cord • 1000 joules surge protection 	DOCK200-BK	Black	\$195
<ul style="list-style-type: none"> • 1 grounded AC outlet 15A rating • 2 USB charging ports with shared 2.1 charging power • 10' 14 AWG power cord • 1000 joules surge protection 	DOCK270-BK	Black	\$205



Wireless charging dock

- Fits 3" grommet hole
- Sits flush with tabletop
- For use with products equipped with wireless charging capabilities

Code	Colour	List Price
WC-BK	Black	\$115



Pop-up power harness

- The power harness is flush mounted and enriches everyday workflow when in use and can be tucked away when not. The AC receptacles are dynamically positioned for simpler power access handling.
- Note: Requires 3" bore for installation and a minimum of 12" clearance under mounting surface to operate correctly.

Outlets	Code	Colour	List Price
<ul style="list-style-type: none"> • 2 AC 125V 12A • Cat. 6 rated RJ45 ethernet coupler • 6' 14 AWG power cord 	TOWER01	Black	\$163
<ul style="list-style-type: none"> • 2 AC receptacles, AC 125V 12A • 2 DC 5V USB charging ports - provides shared 4.2A of charging power • 6' 14 AWG power cord 	TOWER02	Black	\$163

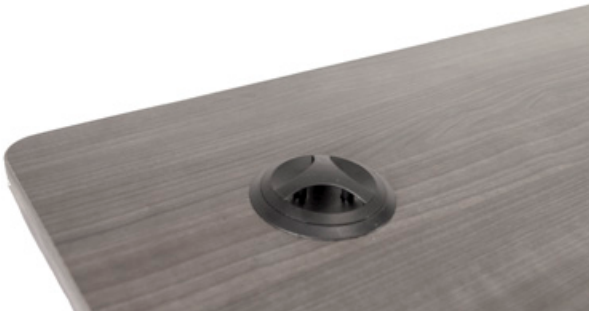

Clamp-on power dock

- 2 AC outlets
- 5V USB charging port

Code	Colour	List Price
CD-WH	White	\$165
CD-SA	Satin Aluminum	\$165



Clamp-on power dock, black

- 2 AC outlets
- 5V USB charging port

Code	Colour	List Price
CD-STA	Black	\$130



ergoCentric cable management trough

- The ergoCentric cable management trough is used to route wires through a discreet cable channel that will improve the aesthetics in just about any room, and is a great and affordable way to conceal and protect cables. Lightweight and easy to handle and install, the mesh cable management trough is available in three width sizes (28",36" and 48") and two colours (black or silver).

Length	Code	Colour	List Price
28"	MCM28-BLACK	Black	\$184
28"	MCM28-SILVER	Silver	\$184
36"	MCM36-BLACK	Black	\$199
36"	MCM36-SILVER	Silver	\$199
48"	MCM48-BLACK	Black	\$235
48"	MCM48-SILVER	Silver	\$235



Power bar with 10' spiral wire

Outlets	Code	Colour	List Price
<ul style="list-style-type: none"> 6 AC outlets 10' 14 AWGx3C spiral power cord Overload protection with reset switch Surge protection. Rating: 125V 60Hz 12A 	POWERBAR	Black	\$170



Power bar with 10' spiral wire and 1' straight daisy chain plug

Outlets	Code	Colour	List Price
<ul style="list-style-type: none"> 6 AC outlets 10' 14 AWGx3C spiral power cord Daisy chain plug with surge protection Overload protection with reset switch Rating: 125V 60Hz 12A Daisy chain plug 	POWERBAR-DC	Black	\$190



Power bar with 10' cord

Outlets	Code	Colour	List Price
<ul style="list-style-type: none"> 6 AC outlets 10' 14 AWGx3C power cord Overload protection with reset switch Rating: 125V 60Hz 12A 	POWERBAR-STA	Black	\$110





Acoustic privacy material options

Acoustic panels [ZIN]

- Acoustic panels absorb internal and external sound influences reducing the noise level in a room
- Sturdy, tackable, recycled plastic
- Panels are ½" thick and available in 6 colours
- 10 day lead time



Blue 01



Navy 02



Cream 03



Silver 04

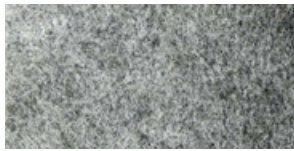

Gray 05

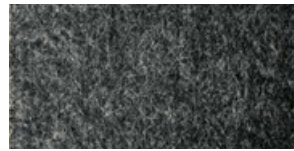

Ash 06

Acoustic privacy panels bracket & clamp options

Clamps

- Clamps for attaching privacy panels to tabletops

Item	Code	List Price
Chrome Clamp (for use with framed or non-framed privacy panels)	9	N/C
Top Mounted Shell Clamp - Silver (for use with non-framed privacy panels only)	5	N/C
Top Mounted Shell Clamp - White (for use with non-framed privacy panels only)	6	N/C



Chrome Clamp

Shell Clamp
Available in silver and white

L-shaped brackets

- L-shaped bracket for attaching modesty and modesty-privacy panels
- Available in silver or white

Item	Code	List Price
L-shaped bracket - Silver	1	N/C
L-shaped bracket - White	2	N/C

L-shaped Bracket
Available in silver and white



Acoustic privacy panels

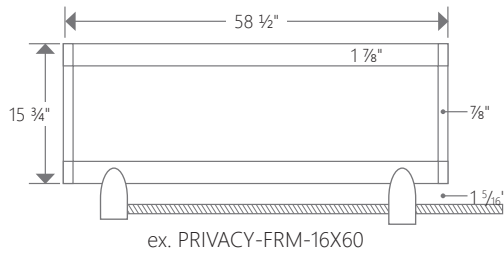

PANEL TYPE	PRODUCT CODE			LIST PRICE
	Size	Panel Colour	Bracket Type	
Acoustic privacy panels – framed	PRIVACY-FRM-16x24	See [ZIN] colour options to the right	See bracket options to the right	\$334
	PRIVACY-FRM-16x30			\$347
	PRIVACY-FRM-16x36			\$360
	PRIVACY-FRM-16x42			\$362
	PRIVACY-FRM-16x48			\$441
	PRIVACY-FRM-16x54			\$468
	PRIVACY-FRM-16x60			\$494
	PRIVACY-FRM-16x66			\$571
	PRIVACY-FRM-16x72			\$598
	PRIVACY-FRM-20x24			\$366
	PRIVACY-FRM-20x30			\$378
	PRIVACY-FRM-20x36			\$391
	PRIVACY-FRM-20x42			\$394
	PRIVACY-FRM-20x48			\$482
	PRIVACY-FRM-20x54			\$513
	PRIVACY-FRM-20x60			\$545
	PRIVACY-FRM-20x66			\$626
PRIVACY-FRM-20x72	\$658			

- Sturdy and tackable acoustic panel with aluminum frame
- Made from recycled materials
- Two heights and multiple widths to accommodate a wide variety of table sizes
- Clamps mount the privacy panels on top of the work surface, without screws

OPTIONS	
ZIN-Colour Selection	
Blue	01
Navy	02
Cream	03
Silver	04
Gray	05
Ash	06
Bracket Type	
Clamp - Chrome	09

Combining Panel Size + Colour + Bracket Codes Acoustic Privacy Panel *PRIVACY-FRM-16X24* + Panel Colour *-01* + Bracket Type Codes *-9* = *PRIVACY-FRM-16X24-01-9*



Acoustic privacy panels – unframed

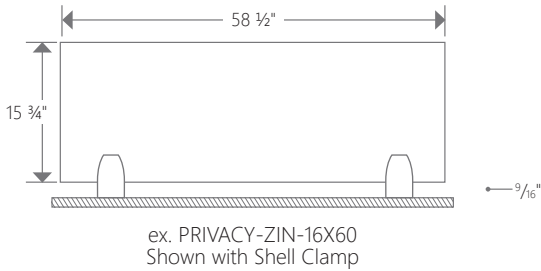

PANEL TYPE	PRODUCT CODE			LIST PRICE
	Size	Panel Colour	Bracket Type	
	PRIVACY-ZIN-12X24			\$198
	PRIVACY-ZIN-12X30			\$198
	PRIVACY-ZIN-12X36			\$198
	PRIVACY-ZIN-12X42			\$235
	PRIVACY-ZIN-12X48			\$242
	PRIVACY-ZIN-12X54			\$274
	PRIVACY-ZIN-12X60			\$288
	PRIVACY-ZIN-12X66			\$346
Acoustic privacy panels – unframed	PRIVACY-ZIN-12X72	See [ZIN] colour options to the right	See bracket options to the right	\$359
	PRIVACY-ZIN-16X24			\$225
	PRIVACY-ZIN-16X30			\$225
	PRIVACY-ZIN-16X36			\$231
	PRIVACY-ZIN-16X42			\$266
	PRIVACY-ZIN-16X48			\$298
	PRIVACY-ZIN-16X54			\$317
	PRIVACY-ZIN-16X60			\$335
	PRIVACY-ZIN-16X66			\$398
	PRIVACY-ZIN-16X72			\$417

- Sturdy and tackable acoustic panel.
- Made from recycled materials
- Two heights and multiple widths to accommodate a wide variety of table sizes
- Shell clamps mount the privacy panels on top of the work surface, using a wood screw

OPTIONS	
ZIN-Colour Selection	
Blue	01
Navy	02
Cream	03
Silver	04
Gray	05
Ash	06
Bracket Type	
Top mounted Shell Clamp - Silver	5
Top mounted Shell Clamp - White	6
Clamp - Chrome	9

Combining Panel Size + Colour + Bracket Codes Acoustic Privacy Panels – Unframed + Panel Colour + Bracket Type Codes = PRIVACY-ZIN-12X24-01-5

Sit down. Stand up.
A healthy way to work.



Warranty

ergoCentric Seating Systems hereby warrants all of its tables and accessory products against defects and functional failure of materials. These warranties shall not apply to any products which must be replaced because of normal wear and tear, negligence, abuse or accident, shipping damage, or product use other than in accordance with written instructions and warnings. ergoCentric makes no warranty that any of its products are suitable for any particular purpose and makes no other warranties, expressed or implied, other than those set forth herein. In no event shall ergoCentric be liable in either tort or contract for any loss or direct, special, incidental, consequential or exemplary damages. This warranty is based on the use during an eight hour work day.

Warranty claims

ergoCentric will repair or replace any product or materials, covered by this warranty, found to be defective or inferior within the warranted period. This warranty includes the cost of labor and shipping. Claims are to be made directly to ergoCentric or to the authorized representative from whom the product was purchased. Product or materials, for which a claim has been made, must be made available for inspection by an authorized ergoCentric representative.

Limit of warranty

These warranties shall be valid only during the term of these warranties; and while the products herein warranted are in the possession of the original purchaser. The original purchaser shall mean the party which first purchased the products for its own use whether from ergoCentric or an authorized ergoCentric representative.

PRODUCT	WARRANTY
upCentric height adjustable frame 2-Leg & 2-Leg Small – 300 lbs & 220 lbs respectively	10 year limited warranty
upCentric height adjustable frame 2-Leg & 2-Leg Small Modular – 250 lbs	10 year limited warranty
upCentric height adjustable frame 3-Leg Modular – 400 lbs	10 year limited warranty
High pressure laminate tabletops	10 years

Customer Service

Grand & Toy

Federal Client Service Team

1-866-511-4534

federalservices@grandandtoy.com

grandandtoy.com/gov



ergoCentric®



upCentric® and ergoCentric® are registered trademarks of ergoCentric Inc.
TiMOTION® is a registered trademark of TiMOTION Technology Co. Ltd.
All other trademarks, registered trademarks and logos are the property of their respective owners.
Published December 2019