

E60PQ-140003/045/PQ - GENERAL TERMS AND CONDITIONS

Pricing in the price guide is subject to change at any time.

The pricing herein will never exceed the Ceiling Price of the GoCUID as submitted to PSPC and as found in the Client Search Tool

Pricing does not include freight, delivery, installation, or applicable taxes

Please note the same GoCUID used in this price guide may be applicable for multiple products. The price shown is specific to the combination of components therein and may be shown below the Ceiling Price as found in the Client Search Tool.

Not all the product Grand & Toy has listed in the Client Search Tool may be included in the price guide. For additional product information and pricing please speak with your Government Sales Representative.

Due to different client needs the final specification of an item may not be shown with a price, please contact your Government Sales Representative for further details.

Due to different client needs and final furniture configurations, final pricing may differ than what is listed.

This price guide does not include information on the full range of available finishes. Please consult with the specific series price list, website, or your Government Sales Representative for full finish specifications.

Grand & Toy does not warrant the accuracy of different components when used in combination with other components if not verified by CAD layout, floor plan, and site measurement.

Images shown in this price guide are representative only. The actual product may differ based on size, orientation, configuration, and option selections.

For warranty, care, and installation instructions please visit the manufacturer's website, product series price list, or your Government Sales Representative

The Warranty and Terms of Service are per the manufacturer's standard manufacturing and operating policies. Where the terms and conditions of the RFSA differ from the published manufacturer policies, the RFSA will take precedence.

The price guide may be updated periodically, the most recent version can be made available on our website or by contacting your Government Sales Representative



ergoCentric
ergotron®



E60PQ-140003/045/PQ - MODALITÉS ET CONDITIONS GÉNÉRALES

Les prix cités dans le guide des prix peuvent être modifiés en tout temps.

Le prix cité aux présentes ne sera jamais supérieur au prix plafond du CIUGdC soumis à SPAC et se trouvant dans l'Outil de recherche.

Les prix cités excluent les frais de transport, de livraison et d'installation ainsi que toute taxe applicable.

Veillez noter que le même CIUGdC utilisé dans ce guide des prix peut viser plusieurs produits. Le prix cité est propre à la combinaison particulière des composants du produit en question et peut être inférieur au prix plafond indiqué dans l'Outil de recherche.

Tous les produits Grand & Toy répertoriés dans l'Outil de recherche ne figurent pas nécessairement dans ce guide des prix. Pour de plus amples renseignements sur les produits et les prix, veuillez communiquer avec votre représentant des ventes gouvernementales.

En raison des besoins différents des clients et de la configuration finale du mobilier, le prix total peut différer de celui indiqué dans cette liste. Pour plus de détails, veuillez communiquer avec votre représentant des ventes gouvernementales.

Ce guide des prix ne contient pas des renseignements sur le choix complet de finis offerts. Pour des renseignements détaillés sur l'ensemble des finis, veuillez consulter la liste de prix de la gamme en question, le site Web ou votre représentant des ventes gouvernementales.

Grand & Toy ne garantit pas l'exactitude des différents composants lorsqu'ils sont utilisés en combinaison avec d'autres composants et s'ils ne sont pas validés selon le plan d'aménagement CAO, le plan d'étage et les mesures du site.

Les images figurant dans ce guide des prix sont présentées à titre indicatif uniquement. La taille, l'orientation, la configuration et les choix d'options du produit proprement dit peuvent différer.

Pour des renseignements complets sur la garantie et des instructions concernant l'entretien ou l'installation des produits, veuillez consulter le site Web du fabricant, la liste de prix de la gamme en question ou votre représentant des ventes gouvernementales.

La garantie et les conditions de service sont conformes aux politiques de fabrication et d'exploitation habituelles en vigueur du fabricant. Lorsque les modalités et conditions de la DAMA diffèrent des politiques publiées du fabricant, la DAMA aura préséance.

Le guide des prix peut être mis à jour périodiquement; vous pouvez toujours trouver la version la plus récente sur notre site Web ou en communiquant avec votre représentant des ventes gouvernementales.



ergoCentric
ergotron®





Contact us for expert advice on all the products and services you need to create a productive workspace.

1.866.511.4534

furniture@grandandtoy.com

grandandtoy.com/gov

Communiquez avec nous pour obtenir des conseils éclairés sur tous les produits et services dont vous avez besoin pour créer un espace de travail productif.

1.866.511.4534

furniture@grandandtoy.com

grandandtoy.com/gouv

APPLICATION NOTES / INSTRUCTIONS D'APPLICATION

- Coordinates with Boulevard and 1200 series Metal
- All drawers are interlocking allowing only one to be opened at a time
- Standard with levelling glides, counter weights, & plate dividers.
- Se coordonne aux finis métalliques des gammes Boulevard et 1200
- Système d'interverrouillage permettant d'ouvrir un seul tiroir à la fois.
- De série avec patins de nivellement, contrepoids et plaques intercalaires.

Filing Cabinet - Lateral - Painted Metal
 Classeur - Latéral - Métal peint

2 Drawers / 2 tiroirs

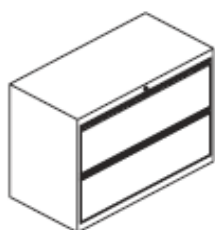

GoCUID / CIUGdC*	Price / Prix	D/P	W/L	H	WT LB	CU
Key / Clé						
3FLT2DXXPM30D18XXXK	\$ 646.75	18	30	27.75	88	10.39
3FLT2DXXPM36D18XXXK	\$ 679.90	18	36	27.75	101	12.37
Electronic / Électronique						
3FLT2DXXPM30D18XXXS	\$ 841.75	18	30	28.5	90	10.39
3FLT2DXXPM36D18XXXS	\$ 874.90	18	36	28.5	103	12.37

* Fixed front drawers / Tiroirs à devantures fixes

3 Drawers / 3 tiroirs

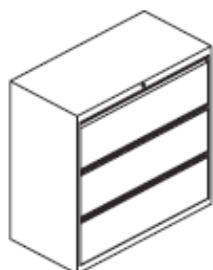

GoCUID / CIUGdC*	Price / Prix	D/P	W/L	H	WT LB	CU
Key / Clé						
3FLT3DXXPM30D18XXXK	\$ 809.90	18	30	40.5	125	14.92
3FLT3DXXPM36D18XXXK	\$ 836.55	18	36	40.5	139	17.77
Electronic / Électronique						
3FLT3DXXPM30D18XXXS	\$ 1,004.90	18	30	40.5	127	14.92
3FLT3DXXPM36D18XXXS	\$ 1,031.55	18	36	40.5	141	17.77

* Fixed front drawers / Tiroirs à devantures fixes

REQUIRED SPECIFICATIONS / SPÉCIFICATIONS REQUISES

- Metal / Métal
- Included/Inclus

4 Drawers / 4 tiroirs



<i>GoCUID / CIUGdC*</i>	<i>Price / Prix</i>	<i>D/P</i>	<i>W/L</i>	<i>H</i>	<i>WT LB</i>	<i>CU</i>
Key / Clé						
3FLT4DXXPM30D18XXXK	\$ 976.95	18	30	54	159	19.63
3FLT4DXXPM36D18XXXK	\$ 1,017.25	18	36	54	177	23.38
Electronic / Électronique						
3FLT4DXXPM30D18XXXS	\$ 1,171.95	18	30	54	161	19.63
3FLT4DXXPM36D18XXXS	\$ 1,212.25	18	36	54	179	23.38

* Fixed front drawers / Tiroirs à devantures fixes

5 Drawers / 5 tiroirs

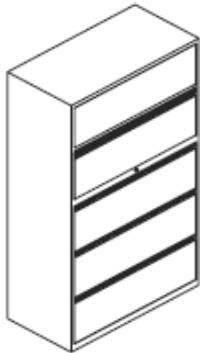

<i>GoCUID / CIUGdC*</i>	<i>Price / Prix</i>	<i>D/P</i>	<i>W/L</i>	<i>H</i>	<i>WT LB</i>	<i>CU</i>
Key / Clé						
3FLT5DXXPM30D18XXXK	\$ 1,143.35	18	30	65.88	195	23.94
3FLT5DXXPM36D18XXXK	\$ 1,180.40	18	36	65.88	216	28.51
Electronic / Électronique						
3FLT5DXXPM30D18XXXS	\$ 1,338.35	18	30	65.88	197	23.94
3FLT5DXXPM36D18XXXS	\$ 1,375.40	18	36	65.88	218	28.51

*Top Receding and Fixed front drawers / Tiroirs supérieurs escamotables et fixes

REQUIRED SPECIFICATIONS / SPÉCIFICATIONS REQUISES

- Metal / Métal

Included/Inclus

APPLICATION NOTES / INSTRUCTIONS D'APPLICATION

- Coordinates with Boulevard and 1200 series Metal / Métales
- All drawers are interlocking allowing only one to be opened at a time
- Se coordonnent aux finis métalliques des gammes Boulevard et série 1200
- Système d'interverrouillage permettant d'ouvrir un seul tiroir à la fois

Filing Cabinet - Vertical - Painted Metal

Classeur - Vertical - Métal peint

2 Drawers / 2 tiroirs

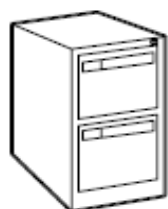

GoCUID / CIUGdC*	Price / Prix	D/P	W/L	H	WT LB	CU
Key / Clé						
3FVT2DXXPM15D28XXXK	\$ 431.60	28	15	28	82	8.3
Electronic / Électronique						
3FVT2DXXPM15D28XXXS	\$ 782.60	28	15	28.75	84	8.30

3 Drawers / 3 tiroirs

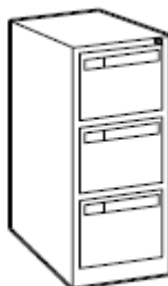

GoCUID / CIUGdC*	Price / Prix	D/P	W/L	H	WT LB	CU
Key / Clé						
3FVT3DXXPM15D28XXXK	\$ 564.85	28	15	40.37	116	11.8
Electronic / Électronique						
3FVT3DXXPM15D28XXXS	\$ 915.85	28	15	41.12	118	11.80

4 Drawers / 4 tiroirs

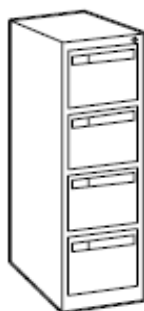

GoCUID / CIUGdC*	Price / Prix	D/P	W/L	H	WT LB	CU
Key / Clé						
3FVT4DXXPM15D28XXXK	\$ 702.00	28	15	52.25	116	11.8
Electronic / Électronique						
3FVT4DXXPM15D28XXXS	\$ 1,053.00	28	15	53.00	118	11.80

REQUIRED SPECIFICATIONS / SPÉCIFICATIONS REQUISES

- Metal / Métal
- Included/Inclus

APPLICATION NOTES / INSTRUCTIONS D'APPLICATION

- May be used in work space, collaborative, and meeting areas
- Co-ordinates with other 1200 series metal storage units
- Mobile BBF and FF pedestals or those with E-lock will not fit under a work surface.
- Peut être utilisé dans les espaces de travail, de collaboration et de réunion
- Se coordonne aux autres unités de rangement en métal de la gamme 1200
- Les caissons mobiles BBF et FF ou ceux dotés d'un verrouillage électronique ne peuvent pas être placés sous une surface de travail.

Pedestals - Painted Metal

Caissons - Métal peint

File-File / Tiroirs classeur-classeur

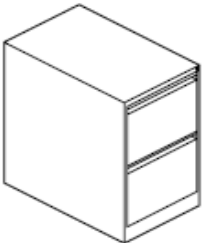
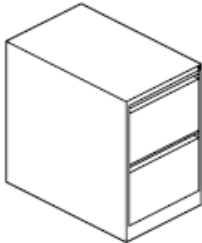
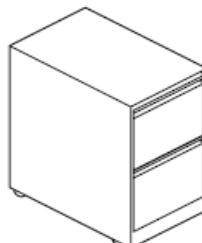
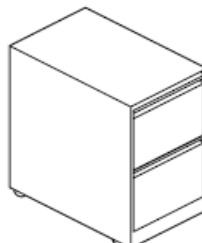
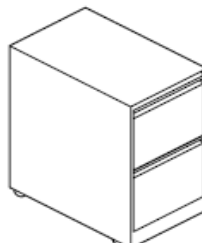
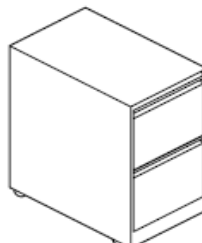
	<i>GoCUID / CIUGdC*</i>	<i>Price / Prix</i>	<i>D/P</i>	<i>W/L</i>	<i>H</i>	<i>WT LB</i>	<i>CU</i>	
	Freestanding / Autoportant							
	3PFSFFXPM15D24XXXK	\$ 299.00	24	15	27.65	72	7.10	Key / Clé
	3PFSFFXPM15D30XXXK	\$ 360.75	30	15	27.65	88	8.77	
	Freestanding / Autoportant							
	3PFSFFXPM15D24XXXS	\$ 590.85	24	15	28.4	74	7.10	Electronic / Électronique
	3PFSFFXPM15D30XXXS	\$ 651.95	30	15	28.4	90	8.77	
	Work Surface Supporting / Support de Surface de Travail							
	3PSSFFXPM15D24XXXK	\$ 299.00	23	15	27.65	72	7.10	Key / Clé
	3PSSFFXPM15D24XXXK	\$ 299.00	24	15	27.65	72	7.10	
	3PSSFFXPM15D30XXXK	\$ 360.75	29	15	27.65	88	8.77	
	3PSSFFXPM15D30XXXK	\$ 360.75	30	15	27.65	88	8.77	
	Work Surface Supporting / Support de Surface de Travail							
	3PSSFFXPM15D24XXXS	\$ 590.85	23	15	28.4	74	7.10	Electronic / Électronique
	3PSSFFXPM15D24XXXS	\$ 590.85	24	15	28.4	74	7.10	
	3PSSFFXPM15D30XXXS	\$ 651.95	29	15	28.4	90	8.77	
	3PSSFFXPM15D30XXXS	\$ 651.95	30	15	28.4	90	8.77	
	Mobile							
	3PMOFFXPM15D18XXXK	\$ 487.50	18	15	29.25	80	5.47	Key / Clé
	3PMOFFXPM15D24XXXK	\$ 499.85	23	15	29.25	90	6.87	
	Mobile							
	3PMOFFXPM15D18XXXS	\$ 778.70	18	15	31.25	82	5.47	Electronic / Électronique
	3PMOFFXPM15D24XXXS	\$ 791.05	23	15	31.25	92	6.87	

REQUIRED SPECIFICATIONS / SPÉCIFICATIONS REQUISES

- Metal / Métal
- Included/Inclus

Grand & Toy

E60PQ-140003/045/PQ

CATEGORY 3 - PEDESTALS - 1200 SERIES

Box-Box-File / Tiroirs utilité-utilité-classeur

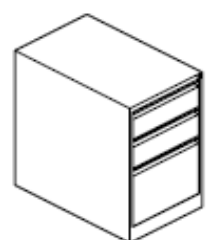

GoCUID / CIUGdC*	Price / Prix	D/P	W/L	H	WT LB	CU
Freestanding / Autoportant						
3PFSBBXXPM15D24XXXK	\$ 299.00	24	15	27.65	76	7.10
3PFSBBXXPM15D30XXXK	\$ 360.75	30	15	27.65	92	8.77

Key / Clé

Freestanding / Autoportant						
3PFSBBXXPM15D24XXXS	\$ 590.85	24	15	28.4	78	7.10
3PFSBBXXPM15D30XXXS	\$ 651.95	30	15	28.4	94	8.77

Electronic /
Électronique

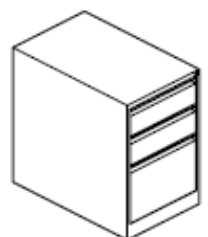

Work Surface Supporting / Support de Surface de Travail						
3PSSBBXXPM15D24XXXK	\$ 299.00	23	15	27.65	76	7.10
3PSSBBXXPM15D24XXXK	\$ 299.00	24	15	27.65	76	7.10
3PSSBBXXPM15D30XXXK	\$ 360.75	29	15	27.65	92	8.77
3PSSBBXXPM15D30XXXK	\$ 360.75	30	15	27.65	92	8.77

Key / Clé

Work Surface Supporting / Support de Surface de Travail						
3PSSBBXXPM15D24XXXS	\$ 590.85	23	15	28.4	78	7.10
3PSSBBXXPM15D24XXXS	\$ 590.85	24	15	28.4	78	7.10
3PSSBBXXPM15D30XXXK	\$ 651.95	29	15	28.4	94	8.77
3PSSBBXXPM15D30XXXK	\$ 651.95	30	15	28.4	94	8.77

Electronic /
Électronique

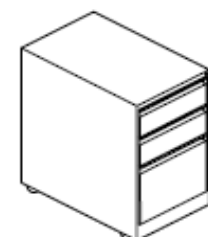

Mobile						
3PMOBBXXPM15D18XXXK	\$ 487.50	18	15	29.25	82	5.47
3PMOBBXXPM15D24XXXK	\$ 499.85	23	15	29.25	94	6.87

Key / Clé

Mobile						
3PMOBBXXPM15D18XXXS	\$ 778.70	18	15	31.25	84	5.47
3PMOBBXXPM15D24XXXS	\$ 791.05	23	15	31.25	96	6.87

Electronic /
Électronique

REQUIRED SPECIFICATIONS / SPÉCIFICATIONS REQUISES

- Metal / Métal

Included/Inclus

Grand & Toy

E60PQ-140003/045/PQ

CATEGORY 3 - PEDESTALS - 1200 SERIES

Box-File / Tiroirs utilité-classeur

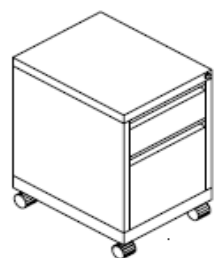

GoCUID / CIUGdC*	Price / Prix	D/P	W/L	H	WT LB	CU
Mobile with Cushion / Mobile avec coussin - GRADE 1						
3PMOBFXXP15D18XXYK	\$ 568.10	18	15	26.125	50	5.00
3PMOBFXXP15D24XXYK	\$ 602.88	23	15	26.125	54	6.00
3PMOBFXXP15D24XXYK	\$ 602.88	24	15	26.125	54	6.00
Mobile with Cushion / Mobile avec coussin - GRADE 2						
3PMOBFXXP15D18XXYK	\$ 603.20	18	15	26.125	50	5.00
3PMOBFXXP15D24XXYK	\$ 642.20	23	15	26.125	54	6.00
3PMOBFXXP15D24XXYK	\$ 642.20	24	15	26.125	54	6.00
Mobile with Cushion / Mobile avec coussin - GRADE 1						
3PMOBFXXP15D18XXYS	\$ 763.10	18	15	26.875	52	5.00
3PMOBFXXP15D24XXYS	\$ 797.88	23	15	26.875	56	6.00
3PMOBFXXP15D24XXYS	\$ 797.88	24	15	26.875	56	6.00
Mobile with Cushion / Mobile avec coussin - GRADE 2						
3PMOBFXXP15D18XXYS	\$ 798.20	18	15	26.875	52	5.00
3PMOBFXXP15D24XXYS	\$ 837.20	23	15	26.875	56	6.00
3PMOBFXXP15D24XXYS	\$ 837.20	24	15	26.875	56	6.00

Key / Clé

Electronic / Électronique

REQUIRED SPECIFICATIONS / SPÉCIFICATIONS REQUISES

- Metal / Métal
 - Fabric / Tissu
- Included/Inclus
Included/Inclus

APPLICATION NOTES / INSTRUCTIONS D'APPLICATION

- May be used in work space, collaborative, and meeting areas
- Work surface supporting pedestals do not have a top
- Free standing pedestals will not fit under a work surface.
- Peut être utilisé dans les espaces de travail, de collaboration et de réunion
- Les caissons supportant la surface de travail n'ont pas de dessus
- Les caissons autoportants ne peuvent pas être installés sous une surface de travail.

SAMPLE APPLICATION / EXEMPLE D'APPLICATION

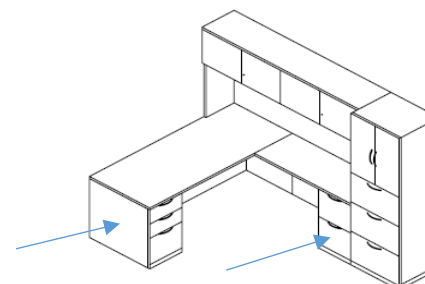

Pedestals - Laminate

Caissons - Stratifié

File-File / Tiroirs classeur-classeur

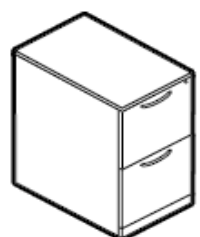

GoCUID / CIUGdC*	Price / Prix	D/P	W/L	H	WT LB	CU
Freestanding / Autoportant						
3PFSFFXLM15D24XXXK	\$ 417.30	24	15.5	29	99	8.00
3PFSFFXLM15D30XXXK	\$ 451.75	30	15.5	29	110	10.00

Key / Clé

Freestanding / Autoportant						
3PFSFFXLM15D24XXXS	\$ 521.30	24	15.5	29	99	8.00
3PFSFFXLM15D30XXXS	\$ 555.75	30	15.5	29	110	10.00

Electronic /
Électronique

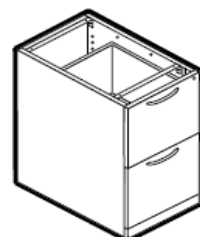

Work Surface Supporting / Support de Surface de Travail						
3PSSFFXLM15D24XXXK	\$ 395.20	23	15.5	28	94	8.00
3PSSFFXLM15D24XXXK	\$ 395.20	24	15.5	28	99	8.00
3PSSFFXLM15D30XXXK	\$ 415.35	29	15.5	28	105	10.00
3PSSFFXLM15D30XXXK	\$ 415.35	30	15.5	28	110	10.00

Key / Clé

Work Surface Supporting / Support de Surface de Travail						
3PSSFFXLM15D24XXXS	\$ 499.20	23	15.5	28	94	8.00
3PSSFFXLM15D24XXXS	\$ 499.20	24	15.5	28	99	8.00
3PSSFFXLM15D30XXXK	\$ 519.35	29	15.5	28	105	10.00
3PSSFFXLM15D30XXXK	\$ 519.35	30	15.5	28	110	10.00

Electronic /
Électronique



Mobile						
3PMOFFXLM15D18XXXK	\$ 471.90	18	15.5	28	99	8.00
3PMOFFXLM15D24XXXK	\$ 501.80	24	15.5	28	110	10.00

Key / Clé

Mobile						
3PMOFFXLM15D18XXXS	\$ 575.90	18	15.5	28	99	8.00
3PMOFFXLM15D24XXXS	\$ 605.80	24	15.5	28	110	10.00

Electronic /
Électronique

REQUIRED SPECIFICATIONS / SPÉCIFICATIONS REQUISES

- Laminate / Stratifié
- Handle / Poignée

Pedestals Box-Box-File / Tiroirs utilité-utilité-classeur

*GoCUID / CIUGdC** *Price / Prix* *D/P* *W/L* *H* *WT LB* *CU*

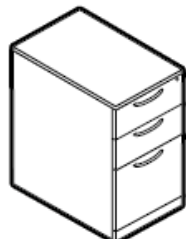

Freestanding / Autoportant							
3PFSBBXLM15D24XXXK	\$ 460.20	24	15.5	29	99	8.00	
3PFSBBXLM15D30XXXK	\$ 479.05	30	15.5	29	110	10.00	

Key / Clé

Freestanding / Autoportant							
3PFSBBXLM15D24XXXS	\$ 564.20	24	15.5	29	99	8.00	
3PFSBBXLM15D30XXXS	\$ 583.05	30	15.5	29	110	10.00	

Electronic /
Électronique

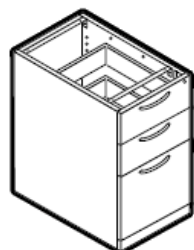

Work Surface Supporting / Support de Surface de Travail							
3PSSBBXLM15D24XXXK	\$ 423.80	23	15.5	28	94	8.00	
3PSSBBXLM15D24XXXK	\$ 423.80	24	15.5	28	99	8.00	
3PSSBBXLM15D30XXXK	\$ 439.40	29	15.5	28	105	10.00	
3PSSBBXLM15D30XXXK	\$ 439.40	30	15.5	28	110	10.00	

Key / Clé

Work Surface Supporting / Support de Surface de Travail							
3PSSBBXLM15D24XXXS	\$ 527.80	23	15.5	28	94	8.00	
3PSSBBXLM15D24XXXS	\$ 527.80	24	15.5	28	99	8.00	
3PSSBBXLM15D30XXXS	\$ 543.40	29	15.5	28	105	10.00	
3PSSBBXLM15D30XXXS	\$ 543.40	30	15.5	28	110	10.00	

Electronic /
Électronique



Mobile							
3PMOBBXLM15D18XXXK	\$ 553.15	18	15.5	28	99	8.00	
3PMOBBXLM15D24XXXK	\$ 585.00	23	15.5	28	110	10.00	

Key / Clé

Mobile							
3PMOBBXLM15D18XXXS	\$ 657.15	18	15.5	28	99	8.00	
3PMOBBXLM15D24XXXS	\$ 689.00	23	15.5	28	110	10.00	

Electronic /
Électronique

REQUIRED SPECIFICATIONS / SPÉCIFICATIONS REQUISES

- Laminate / Stratifié Included/Inclus
- Handle / Poignée Included/Inclus

Grand & Toy

E60PQ-140003/045/PQ

CATEGORY 3 - PEDESTALS - LICENCE

Box-File / Tiroirs utilité-classeur

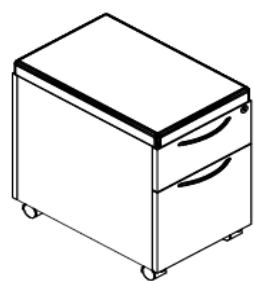

GoCUID / CIUGdC*	Price / Prix	D/P	W/L	H	WT LB	CU	
Mobile with Cushion / Mobile avec coussin - GRADE 1							
3PMOBFXLM15D18XXYK	\$ 503.75	18	15.5	24	101	8.34	Key / Clé
3PMOBFXLM15D24XXYK	\$ 536.90	23	15.5	24	107	8.34	
3PMOBFXLM15D24XXYK	\$ 536.90	24	15.5	24	107	8.34	
Mobile with Cushion / Mobile avec coussin - GRADE 2							
3PMOBFXLM15D18XXYK	\$ 516.75	18	15.5	24	101	8.34	Key / Clé
3PMOBFXLM15D24XXYK	\$ 549.90	23	15.5	24	107	8.34	
3PMOBFXLM15D24XXYK	\$ 549.90	24	15.5	24	107	8.34	
Mobile with Cushion / Mobile avec coussin - GRADE 1							
3PMOBFXLM15D18XXYS	\$ 607.75	18	15.5	24	101	8.34	Electronic / Électronique
3PMOBFXLM15D24XXYS	\$ 640.90	23	15.5	24	107	8.34	
3PMOBFXLM15D24XXYS	\$ 640.90	24	15.5	24	107	8.34	
Mobile with Cushion / Mobile avec coussin - GRADE 2							
3PMOBFXLM15D18XXYS	\$ 620.75	18	15.5	24	101	8.34	Electronic / Électronique
3PMOBFXLM15D24XXYS	\$ 653.90	23	15.5	24	107	8.34	
3PMOBFXLM15D24XXYS	\$ 653.90	24	15.5	24	107	8.34	

REQUIRED SPECIFICATIONS / SPÉCIFICATIONS REQUISES

- Laminate / Stratifié Included/Inclus
- Handle / Poignée Included/Inclus
- Fabric/Tissu Included/Inclus

APPLICATION NOTES / INSTRUCTIONS D'APPLICATION

- May be used in work space, collaborative, and meeting areas
- Co-ordinates with other 1200 Series finishes
- Open storage may be side or front opening, please specify
- Must specify left or right wardrobe when ordering
- Peut être utilisé dans les espaces de travail, de collaboration et de réunion
- Se coordonne aux autres unités de rangement en métal de la gamme 1200
- Le rangement ouvert peut être à ouverture latérale ou frontale, spécifier lors de la commande
- Penderie à gauche ou à droite, spécifier lors de la commande

Personal Storage Towers - Painted Metal
Tours de rangement personnel - Métal peint

Open Storage File-File / Rangement ouvert + tiroirs classeur-classeur

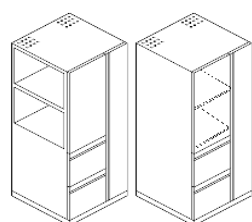

Right / Droite

GoCUID / CIUGdC*	Price / Prix	D/P	W/L	H	WT LB	CU
3TDWOSXXPM24D2454XK	\$ 1,184.95	24	24	54	150	20.88
3TDWOSXXPM24D2456XK	\$ 1,242.15	24	24	66	158	25.36
3TDWOSXXPM24D3054XK	\$ 1,480.70	30	24	54		
3TDWOSXXPM24D3056XK	\$ 1,552.85	30	24	66		

Key / Clé

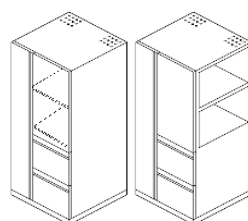

Left / Gauche

3TDWOSXXPM24D2454XS	\$ 1,705.60	24	24	54	150	20.88
3TDWOSXXPM24D2456XS	\$ 1,762.80	24	24	66	158	25.36
3TDWOSXXPM24D3054XS	\$ 2,001.35	30	24	54		
3TDWOSXXPM24D3056XS	\$ 2,073.50	30	24	66		

Electronic /
Électronique

* GoCUID is generic to size and shape but not specific to orientation. Please specify accordingly

* GoCUID est générique pour la taille et la forme mais pas spécifique pour l'orientation. Veuillez spécifier en conséquence

REQUIRED SPECIFICATIONS / SPÉCIFICATIONS REQUISES

- Metal / Métal
- Included/Inclus

Closed Storage File-File / Rangement fermé + tiroirs classeur-classeur

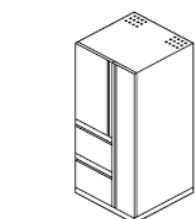

Right / Droite

GoCUID / CIUGdC*	Price / Prix	D/P	W/L	H	WT LB	CU
3TDWCSXXPM24D2454XK	\$ 1,261.65	24	24	54	150	20.88
3TDWCSXXPM24D2456XK	\$ 1,318.85	24	24	66	160	25.36
3TDWCSXXPM24D3054XK	\$ 1,576.90	30	24	54		
3TDWCSXXPM24D3056XK	\$ 1,648.40	30	24	66		

Key / Clé

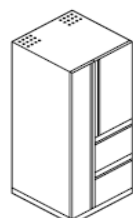

Left / Gauche

3TDWCSXXPM24D2454XS	\$ 1,782.30	24	24	54	150	20.88
3TDWCSXXPM24D2456XS	\$ 1,839.50	24	24	66	160	25.36
3TDWCSXXPM24D3054XS	\$ 2,097.55	30	24	54		
3TDWCSXXPM24D3056XS	\$ 2,169.05	30	24	66		

Electronic /
Électronique

* GoCUID is generic to size and shape but not specific to orientation. Please specify accordingly

* GoCUID est générique pour la taille et la forme mais pas spécifique pour l'orientation. Veuillez spécifier en conséquence

REQUIRED SPECIFICATIONS / SPÉCIFICATIONS REQUISES

- Metal / Métal

Included/Inclus

Grand & Toy

E60PQ-140003/045/PQ

CATEGORY 3 - PERSONAL STORAGE TOWERS - LICENCE

APPLICATION NOTES / INSTRUCTIONS D'APPLICATION

- May be used in work space, collaborative, and meeting areas
- Co-ordinates with Licence casegoods and storage
- Open storage may be side or front opening, please specify
- Must specify left or right wardrobe when ordering
- 66"H units match the height of worksurface and hutch combinations

- Peut être utilisé dans les espaces de travail, de collaboration et de réunion
- Se coordonne avec le mobilier Licence
- Le rangement ouvert peut être à ouverture latérale ou frontale, spécifier lors de la commande
- Penderie à gauche ou à droite, spécifier lors de la commande
- Les unités 66 "H correspondent à la hauteur totale de la surface de travail et du bahut

SAMPLE APPLICATION / EXEMPLE D'APPLICATION

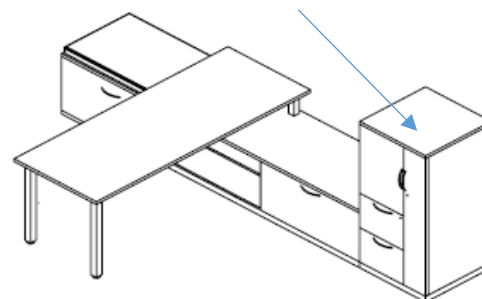

Personal Storage Tower - Laminate

Tour de rangement personnel - Stratifié

Open Storage / Rangement ouvert

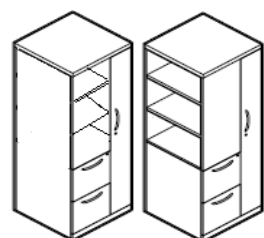

Right / Droite

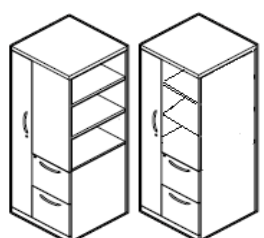

Left / Gauche

GoCUID / CIUGdC*	Price / Prix	D/P	W/L	H	WT LB	CU
3TDWOSXXLM24D2454XK	\$ 961.35	24	24	54	243	22.00
3TDWOSXXLM24D2456XK	\$ 961.35	24	24	66	268	24.00
3TDWOSXXLM30D2454XK	\$ 1,442.03	24	30	54		
3TDWOSXXLM30D2456XK	\$ 1,442.03	24	30	66		
3TDWOSXXLM24D3054XK	\$ 1,442.03	30	24	54		
3TDWOSXXLM24D3056XK	\$ 1,442.03	30	24	66		
3TDWOSXXLM30D3054XK	\$ 1,730.43	30	30	54		
3TDWOSXXLM30D3056XK	\$ 1,730.43	30	30	66		
3TDWOSXXLM24D2454XS	\$ 1,169.35	24	24	54	243	22.00
3TDWOSXXLM24D2456XS	\$ 1,169.35	24	24	66	268	24.00
3TDWOSXXLM30D2454XS	\$ 1,650.03	24	30	54		
3TDWOSXXLM30D2456XS	\$ 1,650.03	24	30	66		
3TDWOSXXLM24D3054XS	\$ 1,650.03	30	24	54		
3TDWOSXXLM24D3056XS	\$ 1,650.03	30	24	66		
3TDWOSXXLM30D3054XS	\$ 1,938.43	30	30	54		
3TDWOSXXLM30D3056XS	\$ 1,938.43	30	30	66		

Key / Clé

Electronic / Électronique

* GoCUID is generic to size and shape but not specific to orientation. Please specify accordingly

* GoCUID est générique pour la taille et la forme mais pas spécifique pour l'orientation. Veuillez spécifier en conséquence

REQUIRED SPECIFICATIONS / SPÉCIFICATIONS REQUISES

- Laminate / Stratifié Included/Inclus
- Handle / Poignée Included/Inclus



Grand & Toy

E60PQ-140003/045/PQ

CATEGORY 3 - PERSONAL STORAGE TOWERS - LICENCE

Closed Storage / Rangement fermé

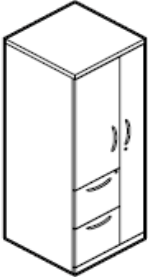
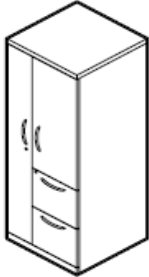
	GoCUID / CIUGdC*	Price / Prix	D/P	W/L	H	WT LB	CU			
 Right / Droite	3TDWCSXXLM24D2454XK	\$ 1,046.50	24	24	54	251	22.00	Key / Clé		
	3TDWCSXXLM24D2456XK	\$ 1,046.50	24	24	66	279	24.00			
	3TDWCSXXLM30D2454XK	\$ 1,569.75	24	30	54					
	3TDWCSXXLM30D2456XK	\$ 1,569.75	24	30	66					
	3TDWCSXXLM24D3054XK	\$ 1,569.75	30	24	54					
	3TDWCSXXLM24D3056XK	\$ 1,569.75	30	24	66					
	3TDWCSXXLM30D3054XK	\$ 1,883.70	30	30	54					
	3TDWCSXXLM30D3056XK	\$ 1,883.70	30	30	66					
	 Left / Gauche	3TDWCSXXLM24D2454XS	\$ 1,254.50	24	24	54	251		22.00	Electronic / Électronique
		3TDWCSXXLM24D2456XS	\$ 1,254.50	24	24	66	279		24.00	
3TDWCSXXLM30D2454XS		\$ 1,777.75	24	30	54					
3TDWCSXXLM30D2456XS		\$ 1,777.75	24	30	66					
3TDWCSXXLM24D3054XS		\$ 1,777.75	30	24	54					
3TDWCSXXLM24D3056XS		\$ 1,777.75	30	24	66					
3TDWCSXXLM30D3054XS		\$ 2,091.70	30	30	54					
3TDWCSXXLM30D3056XS		\$ 2,091.70	30	30	66					

* GoCUID is generic to size and shape but not specific to orientation. Please specify accordingly

* GoCUID est générique pour la taille et la forme mais pas spécifique pour l'orientation. Veuillez spécifier en conséquence

REQUIRED SPECIFICATIONS / SPÉCIFICATIONS REQUISES

- Laminate / Stratifié Included/Inclus
- Handle / Poignée Included/Inclus

APPLICATION NOTES / INSTRUCTIONS D'APPLICATION

- May be used in work space, collaborative, and meeting areas
- Co-ordinates with Boulevard and other 1200 Series finishes
- Peut être utilisé dans les espaces de travail, de collaboration et de réunion
- Se coordonne aux autres unités de rangement en métal de la gamme 1200

Storage Cabinets - Painted Metal
Armoires de rangement - Métal peint

Open / Ouvert

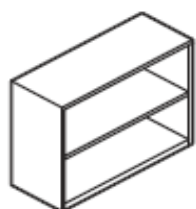

GoCUID / CIUGdC*

Price / Prix

D/P

W/L

H

WT LB

CU

Low Height / Basse

3SOPLHXXPM30D18LOXX	\$ 536.90	18	30	27.75	61	8.26
3SOPLHXXPM36D18LOXX	\$ 552.50	18	36	27.75	71	9.84
3SOPLHXXPM30D20LOXX	\$ 598.00	20	30	27.75		8.26
3SOPLHXXPM36D20LOXX	\$ 614.25	20	36	27.75		9.84

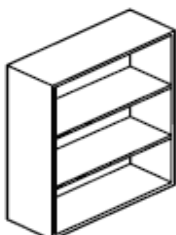

Medium Height / Moyenne

3SOPMHXXPM30D18MEXX	\$ 652.60	18	30	40.5	102	14.93
3SOPMHXXPM36D18MEXX	\$ 690.95	18	36	40.5	115	17.77
3SOPMHXXPM30D20MEXX	\$ 724.75	20	30	40.5		14.93
3SOPMHXXPM36D20MEXX	\$ 768.30	20	36	40.5		17.77

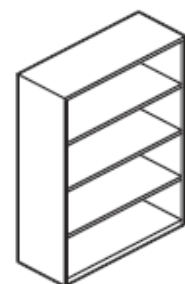

High Height / Haute

3SOPHHXXPM30D18HIXX	\$ 824.85	18	30	54	126	19.76
3SOPHHXXPM36D18HIXX	\$ 863.20	18	36	54	148	23.49
3SOPHHXXPM30D20HIXX	\$ 916.50	20	30	54		19.76
3SOPHHXXPM36D20HIXX	\$ 959.40	20	36	54		23.49

REQUIRED SPECIFICATIONS / SPÉCIFICATIONS REQUISES

- Metal / Métal

Included/Inclus

Grand & Toy

E60PQ-140003/045/PQ

CATEGORY 3 - STORAGE CABINETS - 1200 SERIES

2 Door / 2 portes

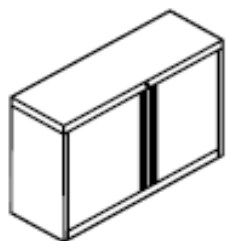

GoCUID / CIUGdC*

Price / Prix

D/P

W/L

H

WT LB

CU

Low Height / Basse

3S2RLHXXPM30D18LOXK	\$ 610.35	18	30	27.75	61	8.26
3S2RLHXXPM36D18LOXK	\$ 630.50	18	36	27.75	71	9.84
3S2RLHXXPM30D20LOXK	\$ 712.40	20	30	27.75		8.26
3S2RLHXXPM36D20LOXK	\$ 736.45	20	36	27.75		9.84
3S2RLHXXPM30D18LOXS	\$ 902.20	18	30	27.75	61	8.26
3S2RLHXXPM36D18LOXS	\$ 922.35	18	36	27.75	71	9.84
3S2RLHXXPM30D20LOXS	\$ 1,004.25	20	30	27.75		8.26
3S2RLHXXPM36D20LOXS	\$ 1,028.30	20	36	27.75		9.84

Key / Clé

Electronic /
Électronique

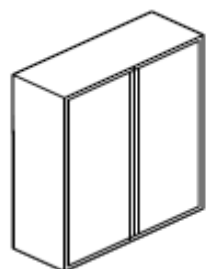

Medium Height / Moyenne

3S2RMHXXPM30D18MEXK	\$ 793.65	18	30	40.5	102	14.93
3S2RMHXXPM36D18MEXK	\$ 813.80	18	36	40.5	115	17.77
3S2RMHXXPM30D20MEXK	\$ 926.90	20	30	40.5		14.93
3S2RMHXXPM36D20MEXK	\$ 950.30	20	36	40.5		17.77
3S2RMHXXPM30D18MEXS	\$ 1,085.50	18	30	40.5	102	14.93
3S2RMHXXPM36D18MEXS	\$ 1,105.65	18	36	40.5	115	17.77
3S2RMHXXPM30D20MEXS	\$ 1,218.10	20	30	40.5		14.93
3S2RMHXXPM36D20MEXS	\$ 1,241.50	20	36	40.5		17.77

Key / Clé

Electronic /
Électronique

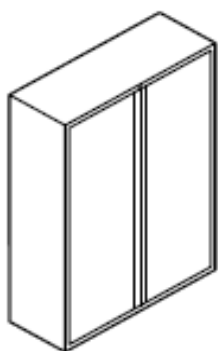

High Height / Haute

3S2RHHXXPM30D18HIXK	\$ 976.95	18	30	54	126	19.76
3S2RHHXXPM36D18HIXK	\$ 1,017.90	18	36	54	148	23.49
3S2RHHXXPM30D20HIXK	\$ 1,140.10	20	30	54		19.76
3S2RHHXXPM36D20HIXK	\$ 1,079.65	20	36	54		23.49
3S2RHHXXPM30D18HIXS	\$ 1,268.80	18	30	54	126	19.76
3S2RHHXXPM36D18HIXS	\$ 1,309.75	18	36	54	148	23.49
3S2RHHXXPM30D20HIXS	\$ 1,431.95	20	30	54		19.76
3S2RHHXXPM36D20HIXS	\$ 1,371.50	20	36	54		23.49

Key / Clé

Electronic /
Électronique

REQUIRED SPECIFICATIONS / SPÉCIFICATIONS REQUISES

- Metal / Métal

Included/Inclus

APPLICATION NOTES / INSTRUCTIONS D'APPLICATION

- May be used in work space, collaborative, and meeting areas
- Co-ordinates with Licence Series details and finishes
- Peut être utilisé dans les espaces de travail, de collaboration et de réunion
- Se coordonne avec le mobilier Licence

SAMPLE APPLICATION / EXEMPLE D'APPLICATION

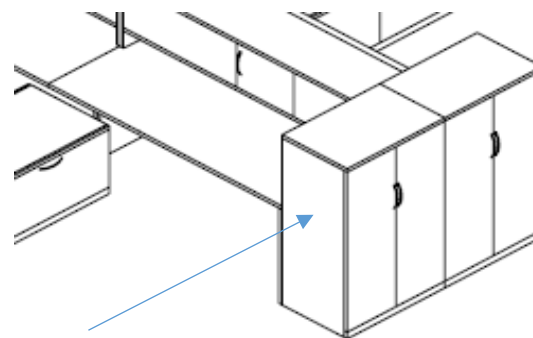

Storage Cabinets - Laminate
Armoires de rangement - Stratifié

Open / Ouvert

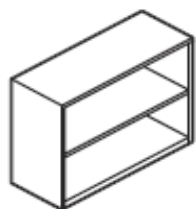

GoCUID / CIUGdC*

Price / Prix

D/P

W/L

H

WT LB

CU

Low Height / Basse

3SOPLHXXLM30D18LOXX	\$ 443.95	18	30	28	82	10.50
3SOPLHXXLM36D18LOXX	\$ 490.75	18	36	28	96	12.50
3SOPLHXXLM30D20LOXX	\$ 443.95	20	30	28	97	13.25
3SOPLHXXLM36D20LOXX	\$ 490.75	20	36	28	112	15.50

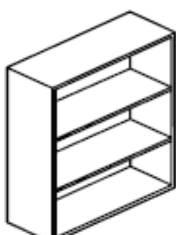

Medium Height / Moyenne

3SOPMHXXLM30D18MEXX	\$ 752.70	18	30	42	112	14.50
3SOPMHXXLM36D18MEXX	\$ 808.60	18	36	42	120	17.50
3SOPMHXXLM30D20MEXX	\$ 752.70	20	30	42	124	18.00
3SOPMHXXLM36D20MEXX	\$ 808.60	20	36	42	142	21.25

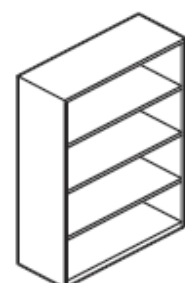

High Height / Haute

3SOPHHXXLM30D18HIXX	\$ 858.65	18	30	54	127	18.50
3SOPHHXXLM36D18HIXX	\$ 926.25	18	36	54	145	21.75
3SOPHHXXLM30D20HIXX	\$ 858.65	20	30	54	158	22.75
3SOPHHXXLM36D20HIXX	\$ 926.25	20	36	54	172	27.00

REQUIRED SPECIFICATIONS / SPÉCIFICATIONS REQUISES

- Laminate / Stratifié
- Included/Inclus

Grand & Toy

E60PQ-140003/045/PQ

CATEGORY 3 - STORAGE CABINETS - LICENCE

2 Door / 2 portes

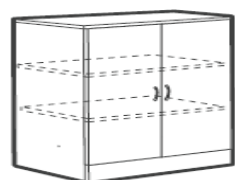

GoCUID / CIUGdC* **Price / Prix** **D/P** **W/L** **H** **WT LB** **CU**

Low Height / Basse

3S2RLHXXLM30D18LOXK	\$ 460.20	18	30	28	94	10.50
3S2RLHXXLM36D18LOXK	\$ 507.00	18	36	28	110	12.50
3S2RLHXXLM30D20LOXK	\$ 460.20	20	30	28	110	13.25
3S2RLHXXLM36D20LOXK	\$ 507.00	20	36	28	126	15.50
3S2RLHXXLM30D18LOXS	\$ 564.20	18	30	28	94	10.50
3S2RLHXXLM36D18LOXS	\$ 611.00	18	36	28	110	12.50
3S2RLHXXLM30D20LOXS	\$ 564.20	20	30	28	110	13.25
3S2RLHXXLM36D20LOXS	\$ 611.00	20	36	28	126	15.50

Key / Clé

Electronic /
Électronique

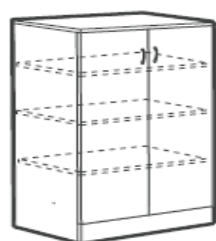

Medium Height / Moyenne

3S2RMHXXLM30D18MEXK	\$ 785.20	18	30	42	122	14.50
3S2RMHXXLM36D18MEXK	\$ 841.10	18	36	42	143	17.50
3S2RMHXXLM30D20MEXK	\$ 785.20	20	30	42	144	18.00
3S2RMHXXLM36D20MEXK	\$ 841.10	20	36	42	166	21.25
3S2RMHXXLM30D18MEXS	\$ 889.20	18	30	42	122	14.50
3S2RMHXXLM36D18MEXS	\$ 945.10	18	36	42	143	17.50
3S2RMHXXLM30D20MEXS	\$ 889.20	20	30	42	144	18.00
3S2RMHXXLM36D20MEXS	\$ 945.10	20	36	42	166	21.25

Key / Clé

Electronic /
Électronique

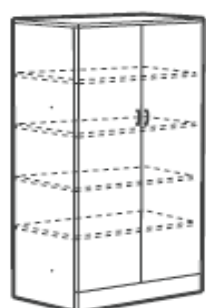

High Height / Haute

3S2RHHXXLM30D18HIXK	\$ 891.15	18	30	54	153	18.50
3S2RHHXXLM36D18HIXK	\$ 958.75	18	36	54	175	21.75
3S2RHHXXLM30D20HIXK	\$ 891.15	20	30	54	185	22.75
3S2RHHXXLM36D20HIXK	\$ 958.75	20	36	54	204	27.00
3S2RHHXXLM30D18HIXS	\$ 995.15	18	30	54	153	18.50
3S2RHHXXLM36D18HIXS	\$ 1,062.75	18	36	54	175	21.75
3S2RHHXXLM30D20HIXS	\$ 995.15	20	30	54	185	22.75
3S2RHHXXLM36D20HIXS	\$ 1,062.75	20	36	54	204	27.00

Key / Clé

Electronic /
Électronique

REQUIRED SPECIFICATIONS / SPÉCIFICATIONS REQUISES

- Laminate / Stratifié Included/Inclus
- Handle / Poignée Included/Inclus

APPLICATION NOTES / INSTRUCTIONS D'APPLICATION

- May be used in work space, collaborative, and meeting areas
- Co-ordinates with Boulevard and other 1200 Series finishes
- Peut être utilisé dans les espaces de travail, de collaboration et de réunion
- Se coordonne aux autres unités de rangement en métal de la gamme 1200

Wardrobes - Painted Metal - 2 Hinged Doors

Armoires-penderies - Métal peint - 2 portes à charnières

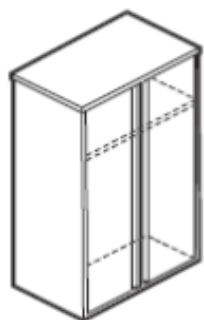

GoCUID / CIUGdC*

Price / Prix

D/P

W/L

H

WT LB

CU

Medium Height / Moyenne

3WHD MHXXPM30D18MEXK	\$ 772.20	18	30	40.5	82	15.00
3WHD MHXXPM36D18MEXK	\$ 863.20	18	36	40.5	91	17.80
3WHD MHXXPM30D24MEXK	\$ 1,030.25	24	30	40.5		
3WHD MHXXPM36D24MEXK	\$ 1,233.05	24	36	40.5		

Key / Clé

3WHD MHXXPM30D18MEXS	\$ 1,029.60	18	30	40.5	82	15.00
3WHD MHXXPM36D18MEXS	\$ 1,119.95	18	36	40.5	91	17.80
3WHD MHXXPM30D24MEXS	\$ 1,112.15	24	30	40.5		
3WHD MHXXPM36D24MEXS	\$ 1,407.90	24	36	40.5		

Electronic /
Électronique

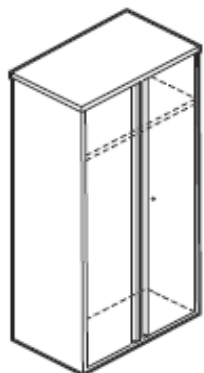

High Height / Haute

3WHDH HXXPM30D18HIXK	\$ 798.85	18	30	54	103	19.75
3WHDH HXXPM36D18HIXK	\$ 889.85	18	36	54	114	23.50
3WHDH HXXPM30D24HIXK	\$ 1,112.15	24	30	54		
3WHDH HXXPM36D24HIXK	\$ 1,233.05	24	36	54		

Key / Clé

3WHDH HXXPM30D18HIXS	\$ 1,090.70	18	30	54	103	19.75
3WHDH HXXPM36D18HIXS	\$ 1,181.70	18	36	54	114	23.50
3WHDH HXXPM30D24HIXS	\$ 1,287.00	24	30	54		
3WHDH HXXPM36D24HIXS	\$ 1,489.80	24	36	54		

Electronic /
Électronique

REQUIRED SPECIFICATIONS / SPÉCIFICATIONS REQUISES

- Metal / Métal

Included/Inclus

APPLICATION NOTES / INSTRUCTIONS D'APPLICATION

- May be used in work space, collaborative, and meeting areas
- Co-ordinates with Licence series and finishes
- Peut être utilisé dans les espaces de travail, de collaboration et de réunion
- Se coordonne avec le mobilier Licence

Wardrobes - Laminate - 2 Hinged Doors

Armoires-penderies - Stratifié - 2 portes à charnières

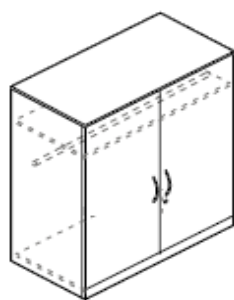

GoCUID / CIUGdC*

Price / Prix

D/P

W/L

H

WT LB

CU

Medium Height / Moyenne

3WHDMHXXLM30D18MEXK	\$ 718.25	18	30	42	122	14.50
3WHDMHXXLM36D18MEXK	\$ 757.90	18	36	42	143	17.50
3WHDMHXXLM30D24MEXK	\$ 746.85	24	30	42	144	18.00
3WHDMHXXLM36D24MEXK	\$ 787.80	24	36	42	166	21.25
3WHDMHXXLM30D18MEXS	\$ 822.25	18	30	42	122	14.50
3WHDMHXXLM36D18MEXS	\$ 861.90	18	36	42	143	17.50
3WHDMHXXLM30D24MEXS	\$ 850.85	24	30	42	144	18.00
3WHDMHXXLM36D24MEXS	\$ 891.80	24	36	42	166	21.25

Key / Clé

Electronic /
Électronique

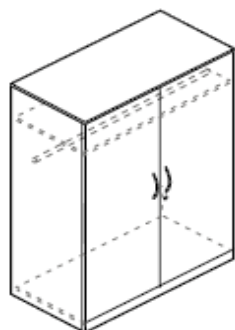

High Height / Haute

3WHDHXXLM30D18HIXK	\$ 787.15	18	30	54	153	18.50
3WHDHXXLM36D18HIXK	\$ 828.75	18	36	54	175	21.75
3WHDHXXLM30D24HIXK	\$ 818.35	24	30	54	185	22.75
3WHDHXXLM36D24HIXK	\$ 861.25	24	36	54	204	27.00
3WHDHXXLM30D18HIXS	\$ 891.15	18	30	54	153	18.50
3WHDHXXLM36D18HIXS	\$ 932.75	18	36	54	175	21.75
3WHDHXXLM30D24HIXS	\$ 922.35	24	30	54	185	22.75
3WHDHXXLM36D24HIXS	\$ 965.25	24	36	54	204	27.00

Key / Clé

Electronic /
Électronique

REQUIRED SPECIFICATIONS / SPÉCIFICATIONS REQUISES

- Laminate / Stratifié Included/Inclus
- Handle / Poignée Included/Inclus

