

ergoCentric Office & Specialty Seating

Canadian Federal Government Price Book

Federal Government

Supply Arrangement

SA # E60PQ-120001/003/PQ

Effective September 1, 2022

For more information, please visit:
ergocentric.com/government



ergoCentric[®]

The science of sitting™

Table of Contents

About ergoCentric	1
Terms and conditions of sale	4
tCentric Hybrid™ and airCentric™ 2 and 2S warranty	6
Office lifetime warranty	8
Specialty seating warranty	9
How to use this price book	10

ergoCentric office seating

tCentric Hybrid™ Series	
Upholstered Backrest (Accent, Office Task, Boardroom, Counter Height)	11
All Mesh (Office Task, Boardroom)	19
Upholstered Seat (Accent, Office Task, Boardroom, Counter Height)	22
Guest Chair	28
airCentric™ 2 Series (Office Task, Boardroom)	30
airCentric™ Stacker	36
geoCentric™ Series (Office Task, Stacker)	38
eCentric™ Executive Series (Office Task, Plus Size, Heavy Duty)	43
Saffron Series (Office Task)	49
ecoCentric™ Mesh Series (Office Task)	52
iCentric™ Stacker	56
ergoForce™ Series (Office Task, Plus Size)	58
24Centric™ Series (24 Hour Multi Tilt)	63

ergoCentric specialty seating

ergoCentric Sit Stand	66
3-in-1 Sit Stand	67
Scooter Stool	68
Ind F Series	69
Ind 2F Series	70

Arms

Height Adjustable	72
Height & Swivel Adjustable	73
Height & Lateral	74
Height, Lateral & Swivel	74

Options and accessories

Options	76
Casters and Glides	79
Seating dimensions	80
Fabric Grades & Upholstery	81
Customer's own materials	82

About ergoCentric

ergoCentric's mission is to design and manufacture the best ergonomic seating in the world. This mission is supported by two guiding principles, the assurance that the task chair properly fits the individual using it, and by ensuring the lowest possible cost of ownership over the full life of the chair.

Many of our adjustment features are unique to ergoCentric and were created in response to our customers' needs. Available adjustment features include back height, lumbar depth, back angle, seat height, seat angle, seat depth and tension adjustments, highly adjustable arms and headrest.

We're here to help

We strive to maintain complete customer satisfaction and to accomplish this we aim to develop useful tools to help everyone who selects and uses our products. ergoCentric.com, contains many updated tools to keep you fully informed about our product details, adjustment videos, finish selections and much more.

Our Inside Sales team are available Monday through Friday to assist you. If you have any questions about navigating this book or what best suits your environment, please contact us [1 866 GET ERGO](tel:1866GETERGO) or orders@ergocentric.com

Committed to quality designs and environmental protection

Responsible manufacturing

ergoCentric has received GREENGUARD® Gold certification for indoor air quality for our chair series, the most stringent emissions criteria for office furniture products. ergoCentric's commitment to environmental protection is a natural product of our concerns for workplace health and safety. As a result, we have earned the ISO 14001 international standard for environmental management systems.

ergoCentric has also achieved the BIFMA e3 Furniture Sustainability Standard. e3 considers how sustainable a product is from multiple perspectives, including the company's social actions, energy usage, material selection and human and ecosystem impacts.

Quality assurance

All ergoCentric seating is tested to meet or surpass North American quality standards and we are ISO 9001 certified.



The ergoCentric advantage

Unique serial number system

Every chair manufactured or distributed by ergoCentric has its own serial number affixed under the seat and that number is entered into our database, noting the specifications of the chair, as well as any customizations. This system allows you to easily manage your facility, and makes reordering chairs and parts simple, while allowing us to quickly attend to any required warranty work.

ergoCentric®

SEATING SYSTEMS
1-866-438-3746

Serial# 365879

Terms and conditions of sale

1. PRICES AND TERMS

Prices are suggested list and are subject to change without notice. Orders will be invoiced subject to prices prevailing at time of shipment F.O.B. factory. Terms are net 30 days from date of invoice. We reserve the right to withhold shipment of orders due to customer's failure to provide current credit information or failure to pay past due invoices. A late payment penalty of 1.5% per month will be charged for accounts over 30 days.

2. CHANGE/CANCELLATION

Customer's cancellation and/or change to an acknowledged purchase order must be confirmed in writing and will be accepted subject to our ability to conform. Cancellations or changes will not be accepted if manufacturing is in process or merchandise has been shipped in compliance with customer's original order.

3. RETURNS

Return authorization (RA) is required for all returned merchandise. Only packages that have an RA number clearly indicated on the outside of the box will be accepted by ergoCentric. To obtain an RA number, please contact your Customer Account Manager. Shipping must be prepaid and ergoCentric reserves the right to charge an additional restocking fee. Merchandise must be received in excellent condition and damaged returns will be subject to an additional charge. Custom fabricated merchandise cannot be returned for credit.

4. SHIPPING

All delivery dates quoted are approximate. Orders may be shipped at one time or in partial shipments. Orders may be subject to delay due to, failure or delay from source of supply, transportation difficulties, or other causes beyond our control.

5. SHIPPING CLAIMS

All shipments are packed in compliance with common carrier requirements. Shipment is the customer's responsibility after leaving our shipping dock. Customer must note all visible damage to cartons and/or carton shortages immediately upon receiving shipment and direct all claims within 5 days to the transportation company making delivery.

6. RECEIVING

Special receiving arrangements must be specified in advance on customer's P.O. and covered at the customer's expense.

7. STORAGE

When the customer's order is ready for shipment and the customer is unwilling or unable to accept delivery, we reserve the right to invoice at that time and transfer the shipment to storage at the customer's risk and expense.

8. REDELIVERY CHARGES

All redelivery costs incurred will be charged to the customer if the original delivery was made in accordance with the customer's purchase order.

9. NOTICE OF CLAIM

Please inspect all deliveries and notify us in writing of any deficiency or departure from the terms of our agreement. Unless we receive from you a written notice of claim within 10 days following delivery you will be deemed to have waived any claim to the contrary.

10. MEASUREMENTS

Though every effort has been made to make product measurements as precise as possible, they must be considered approximate. Pneumatic Lift ranges are within ½".

11. CUSTOMER'S OWN MATERIAL (TRADITIONAL COM)

Fabric must be shipped to the factory prepaid. Yardage indicated in this price book are approximate, based on 54" non directional, no patterned goods. Additional yardage is required for directional, patterned and lesser width materials. The customer is responsible for providing instructions on leftover fabric. ergoCentric will stock leftover fabric for two years.

Materials will be applied in the manner ergoCentric deems is appropriate, unless specifically instructed. ergoCentric reserves the right to reject any material as unsuitable.

In accepting COM fabric, ergoCentric assumes no responsibility for fabric wear, defects or appropriateness. When supplying COM, the shipment must be clearly tagged with customer's order number, description of product, quantity of fabric and any special instructions. ergoCentric will not accept COM that is sent collect.

12. MISCELLANEOUS

Due to variations in materials and colour shades of which we have no control, all chairs are sold subject to minor variations or irregularities in Colour, texture and grain.

We reserve the right to make technical changes in design without prior notice according to latest developments.

tCentric Hybrid™ and airCentric™ 2 & 2S warranty

12 years, 3 shifts, labour included

Our warranty covers everything – including casters, pneumatic cylinders, arms, foam and all moving mechanisms.

At ergoCentric, we are committed to improving the health and productivity of your valued employees at the lowest total cost of ownership.

All tCentric Hybrid, airCentric 2 and airCentric 2S seating are backed by our 12 year, 3 shift warranty, except as limited or described below.

ergoCentric materials

10 years

ergoCentric Approved fabrics (exceptions covered under 12-year warranty include: tCentric Hybrid mesh.)

Other manufacturers' products

ergoCentric does not warrant customer's own fabrics but will pass through to the original purchaser any warranty supplied by the fabric manufacturers to the extent possible.



Provisions that apply to all tCentric Hybrid, airCentric 2 and airCentric 2S seating and services:

ergoCentric warrants the tCentric Hybrid Multi Tilt and Synchro Glide, the airCentric 2 Multi Tilt and Synchro Glide and the airCentric 2S Multi Tilt and Synchro Glide seating systems to be free from defects in material and workmanship, regardless of the number of shifts during which the products are used, for the warranty periods specified above for users weighing up to 350 pounds and 24/7 use. All other mechanism are warranted 280 pounds and 24/7 use.

During the applicable warranty period, ergoCentric, as its sole obligation, will repair or replace (at its option) any product, part, or component covered by this warranty and sold after the effective date of this warranty, which fails under normal use as a result of a defect in material or workmanship. ergoCentric will repair or replace the aforementioned product, part, or component with a comparable product, part, or component.

This warranty extends only to the original purchasers who acquire new product from ergoCentric, its subsidiaries, or its authorized resellers. Any product, part, or component must have been used according to ergoCentric's published instructions and installed and maintained by an ergoCentric factory-trained technician or an authorized ergoCentric dealer installer. If these requirements are met, warranty coverage will be extended. Any misuse, abuse, or modification to the original product voids the warranty. ergoCentric does not warrant the performance of the product when used in combination with other than original ergoCentric product.

Limited warranty only covers ergoCentric provided products, components, and related repair work performed by ergoCentric authorized dealers.

The warranty period starts from the date of purchase.

This document inclusively describes all of the warranties given and remedies available with respect to the company's products and services. ergoCentric and its subsidiaries disclaim any other warranty whether express or implied, statutory or otherwise, in relation to the products.

ergoCentric does not warrant:

- changes in surface finishes, including colourfastness, due to aging, exposure to light or direct sunlight
- marks, scars, or wrinkles occurring naturally in leather
- failure resulting from normal wear and tear
- pilling of textiles
- matching of colours, grains, or textures of natural materials
- colourfastness or the matching of colours of textiles or surface finishes, including an exact match to cuttings, samples, or swatch cards
- damage or marking of materials or abrading of textiles over time caused by sharp or foreign objects
- discolouration of textiles and surface materials due to soiling, stains, or dye transfer from clothing, including denim

ergoCentric tests Customer's Own Material (COM) and other customer-supplied items for manufacturing quality only and does not provide any warranty with regard to these materials.

ergoCentric does not warrant products that are exposed to extreme environmental conditions or that have been subject to improper storage.

To the extent allowed by law, any implied warranties, including any warranty of merchantability or fitness for a particular purpose, are disclaimed and to the extent they are legally required, are limited in duration to the duration of this written warranty.

ergoCentric shall not be liable for loss of time, inconvenience, commercial loss, or incidental or consequential damages.



Office lifetime warranty

ergoCentric Seating Systems hereby warrants all of its Office & Specialty Seating products (see separate tCentric Hybrid™, airCentric™ 2 and airCentric 2S warranty) against defects and functional failure of materials including the pneumatic lift, for as long as the chair is in use by the original purchaser, with the following exceptions: the Mechanisms, arms, foam and fabrics part of the ergoCentric Approved fabrics program are warranted for ten years from the date of purchase. The iCentric™ Mesh backrest structure and iCentric Mesh upholstery, CORE vinyl, Spirit Millennium vinyl, Canter EPU, Beeline EPU and Frixion healthcare upholstery material are warranted for five years from the date of purchase. These warranties shall not apply to any products which must be replaced because of normal wear and tear, negligence, abuse or accident, shipping damage, or product use other than in accordance with written instructions and warnings. ergoCentric makes no warranty that any of its products are suitable for any particular purpose and makes no other warranties, expressed or implied, other than those set forth herein. In no event shall ergoCentric be liable in either tort or contract for any loss or direct, special, incidental, consequential or exemplary damages.

This warranty is based on an eight hour work day only for users weighing up to 300 lbs (136 kgs) for the following series: geoCentric™, myCentric™, eCentric™, eCentric Executive, ergoForce™, iCentric Stacker and for users weighing up to 280 lbs (127 kgs) for the following series: Saffron R, Saffron, ecoCentric™ Mesh, ecoCentric, iCentric, iCentric Mesh, Upholstered and 3-in-1 Sit Stands, the ergoCentric Sit Stand, Starbase, and Scooter Stool.

Plus Size, Heavy Duty, 24 Hour Seating, Bariatric

The mechanisms, arms, foam and fabric are warranted for five years from the date of purchase. The Plus Size seating warranty is valid for users weighing up to 350 lbs. The eCentric Executive Heavy Duty seating warranty is valid for users weighing up to 400 lbs. For all 24 Hour seating, the warranty is valid for continuous use multi-shift operations for users weighing up to 300 lbs. The Bariatric Task chair warranty is valid for users weighing up to 500 lbs. The Bariatric Guest Chairs are warranted up to the following weights: 21" (350 lbs), 24" (450 lbs), 30" (750 lbs).

Warranty claims

ergoCentric will repair or replace any product or materials, covered by this warranty, found to be defective or inferior within the warranted period. This warranty includes the cost of labor and shipping. Claims are to be made directly to ergoCentric or to the authorized dealer from whom the chairs were purchased. Product or materials for which a claim has been made, must be made available for inspection by an authorized ergoCentric representative.

Limit of warranty

These manufacturer's warranties shall be valid only during the term of these warranties; and while the products herein warranted are in the possession of the original purchaser. The original purchaser shall mean the party which first purchased the products for its own use whether from ergoCentric or an authorized ergoCentric dealer.

OFFICE SEATING

LIFETIME*

- Original purchaser
- Defects and functional failure of materials up to a weight of 300 lbs for the following series: geoCentric, myCentric, eCentric Executive, ergoForce, iCentric Stacker
- Defects and functional failure of materials up to a weight of 280 lbs for the following series: Saffron R, Saffron, ecoCentric, ecoCentric Mesh, ecoCentric II, ecoCentric III, iCentric Mesh, Upholstered and 3-in-1 Sit Stands and Scooter

10 YEARS*

- Mechanisms, arms, foam, ergoCentric Approved fabrics

5 YEARS*

- Plus Size seating up to a weight of 350 lbs
- 24 Hour seating for multi-shift workers up to a weight of 300 lbs
- eCentric Executive Heavy Duty seating up to a weight of 400 lbs
- Bariatric Task Chair up to a weight of 500 lbs
- Bariatric Guest Chairs are warranted up to the following weights: 21" (350 lbs), 24" (450 lbs), 30" (750 lbs).
- Bariatric Heavy Duty Stools are warranted up to the following weights: 350 (350 lbs) and 500 (500 lbs)
- iCentric Mesh backrest structure and iCentric Mesh upholstery, CORE vinyl, Spirit Millennium vinyl, Canter EPU, Beeline EPU and Frixion healthcare fabric.

*Includes labor costs

Specialty seating warranty

Specialty Seating Limited Warranty

ergoCentric Seating Systems hereby warrants all of its industrial seating products against defects and functional failure of materials, for five years from the date of purchase. These warranties shall not apply to any products, which must be replaced because of normal wear and tear, negligence, abuse or accident, shipping damage, or product use other than in accordance with written instructions and warnings. ergoCentric makes no warranty that any of its products are suitable for any particular purpose and makes no other warranties, expressed or implied, other than those set forth herein. In no event shall ergoCentric be liable in either tort or contract for any loss or direct, special, incidental, consequential or exemplary damages. This warranty is based on an eight hour work day for users weighing up to 280 lbs.

Warranty claims

ergoCentric will repair or replace any product or materials, covered by this warranty, found to be defective or inferior within the warranted period. This warranty includes the cost of labor and shipping. Claims are to be made directly to ergoCentric or to the authorized dealer from whom the chairs were purchased. Product or materials for which a claim has been made, must be made available for inspection by an authorized ergoCentric representative.

Limit of warranty

These manufacturer's warranties shall be valid only during the term of these warranties; and while the products herein warranted are in the possession of the original purchaser. The original purchaser shall mean the party which first purchased the products for its own use whether from ergoCentric or an authorized ergoCentric dealer.

Cleanroom Seating Lifetime Limited Warranty

ergoCentric® Seating Systems hereby warrants all of its Cleanroom seating products against defects and functional failure of materials, for as long as the chair is in use by the original purchaser, with the following exceptions: the mechanisms, arms, foam and fabric including vinyl, are warranted for five years from the date of purchase. These warranties shall not apply to any products which must be replaced because of normal wear and tear, negligence, abuse or accident, shipping damage, or product use other than in accordance with written instructions and warnings. ergoCentric makes no warranty that any of its products are suitable for any particular purpose and makes no other warranties, expressed or implied, other than those set forth herein. In no event shall ergoCentric be liable in either tort or contract for any loss or direct, special, incidental, consequential or exemplary damages. This warranty is based on an eight hour work day only for users weighing up to 280 lbs.

FACTORY/INDUSTRIAL	CLEANROOM/LABORATORY
<p>5 YEARS*</p> <ul style="list-style-type: none"> Original purchaser Defects and functional failure of materials up to a weight of 280 lbs Mechanisms, arms, foam 	<p>5 YEARS*</p> <ul style="list-style-type: none"> Original purchaser Defects and functional failure of materials up to a weight of 280 lbs Mechanisms, arms, foam, fabric, vinyl, PVC-free (vinyl-like) upholstery (with the exception of Silica upholstery)
<p>10 YEARS*</p> <ul style="list-style-type: none"> IC Plus: Cracking, punctures and tears and use of Rescue, Virox 5, Cavicide, Wex-Cide and bleach cleaning agents when used in accordance with the cleaning agents' labeled instructions. 	<p>*Includes labour costs</p>

How to use this price book

The following page is a typical example of the seating specifications you will find throughout this price book. In the top header bar of each table, you will find the chair model code. In this example, the *geoCentric Multi Tilt Series* is illustrated.

TABLE	DESCRIPTION
1 List Price	List prices for fabric, leather, and COM grades are listed.
2 Standard Specifications	Standard features are listed. The dot (•) symbol indicates that feature is available for the respective chair model.
3 Options	Options are listed by category (e.g., seat) for each chair model. <ul style="list-style-type: none"> A The upcharge column lists the additional list prices for each available option. "N/C" indicates <i>No Charge</i> B Columns with a model code heading (geo-MB-MT, geo-TB-MT, geo-XTB-MT) indicate if the option is available for the respective chair model. <ul style="list-style-type: none"> • The dot (•) symbol means the option is available. • "N/A" indicates the option is not available. • "incl." means the option is already included as part of the chair model's standard features.
4 Arm Options	Shows the most popular arm options for the chair model. Arm option specifications and additional arm options are available on pages 69-71.

For this example, the geo-MB-MT model has been chosen and the selected options highlighted. This specific chair is upholstered in Open House Onyx, a Grade 1 fabric chosen from a sample fabric card. The 4" Adjustable T-Arm with Oval Tube arm pads, has been selected from page 105.

		LIST PRICE	
Model	geo-MB-MT		
Grade 1 Textile	Open House Onyx	\$1,264	1 2
Energy Absorbant Memory Foam Seat	EA	\$92	3
80 mm Pneumatic Lift	80mm	N/C	A B
Dual Wheel Urethane Casters	UC	\$54	
4" Adjustable T-Arm	4ATAOT	\$317	4
Total List Price		\$1,727	

This chair is a: **geo-MB-MT-OpenHouseOnyx-EA-80mm-UC-4ATAOT**

geoCentric™

Multi Tilt Series

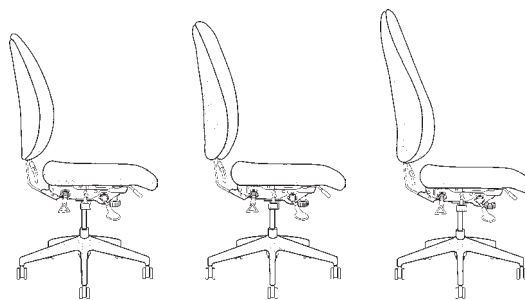

geoCentric Extra Tall-Back

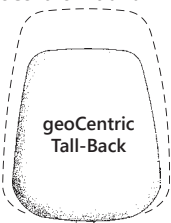

geoCentric Tall-Back

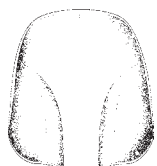

Back Cap PBCMBF

Standard on vinyl and PVC Free (vinyl like) upholsteries. Ideal for extra durability and cleanability.

RECOMMENDED ARMS



4" Adjustable T-Arm

4ATAOT \$317

4



3" Adjustable T-Arm

3ATAOT \$208

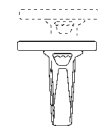

4" Adjustable Swivel Arm

SWV \$476

For specifications, illustrations and additional arm options, see pages 69-71.

SEAT SIZE OPTIONS

Extra Small XSS \$92
(17 1/2" w x 15 1/2" d)

Small SS N/C
(18 1/2" w x 17" d)

Plus Size PS \$92
(22" w x 19" d)

Extra Long XLS \$92
(20" w x 21" d)

Extra Deep XPS \$92
(22" w x 21" d)

For graded in upholstery choices see page 78.

LIST PRICE	List Price	geo-MB-MT	geo-TB-MT	geo-XTB-MT
	• Grade 1/COM (yd)	\$1,264 (1 1/2)	\$1,295 (2)	\$1,422 (2)
	• Grade 2	\$1,289	\$1,325	\$1,457
	• Grade 3	\$1,314	\$1,355	\$1,492
	• Grade 4	\$1,339	\$1,385	\$1,527
	• Grade 5	\$1,364	\$1,415	\$1,562
1	• Leather Match	\$1,609	\$1,670	\$1,832
	• Leather	\$1,834	\$1,900	\$2,072
	• Back Cap Standard with Vinyl, PVC-free (vinyl-like) Upholsteries	(\$17)	N/A	N/A

STANDARD SPECIFICATIONS	Backrest	geo-MB-MT	geo-TB-MT	geo-XTB-MT
	• 5" Patented back height adjustment system	•	•	•
	• Fully upholstered dual curve backrest	17" w x 19" h	17" w x 21" h	19" w x 25" h
	Seat			
	• Dual density molded polyurethane foam	•	•	•
	• Eight ply hardwood seat structure	•	•	•
	• Tailored upholstery on seat pan*	20" w x 19" d	20" w x 19" d	20" w x 19" d
	Multi Tilt Mechanism			
	• Infinite lock free float	•	•	•
	• Back angle adjustment	•	•	•
• Adjustable spring tension	•	•	•	
• Infinite forward tilt lock out	•	•	•	
• 2 1/2" Depth adjustable seat slider	•	•	•	
Pneumatic Lift (seat height)				
• 125 mmLT pneumatic lift (16" - 20 1/2")	•	•	•	
Base				
• 26" Glass reinforced nylon mid-profile base	•	•	•	
• 5 Dual wheel nylon casters 2	•	•	•	
Measurements				
• Boxed weight/size	49 lbs/6.7 cu.ft	52 lbs/10 3/4 cu.ft	56 lbs/11.7 cu.ft	

OPTIONS	Seat	Upcharge	geo-MB-MT	geo-TB-MT	geo-XTB-MT	
	• Energy absorbant memory foam	EA	\$92	•	•	•
	• Triple density foam (adds 3/4" to seat width & depth)	TDF	\$76	•	•	•
	• Non-tailored seat pan	NTS	N/C	•	•	•
	Base/ Glides/ Casters					
	• 26" Polished aluminum mid-profile base	PMB	\$198	•	•	•
	• Silver accent casters	CAC	\$113	•	•	•
	• Dual wheel urethane casters	UC	\$54	•	•	•
	• Single wheel nylon casters	SW	\$74	•	•	•
	• Single wheel urethane casters	SWU	\$82	•	•	•
• 2 1/4" Glides	2G	N/C	•	•	•	
Lifts (seat height)						
• 70 mm pneumatic lift (15 1/2" - 18 1/4")	70MM	N/C	•	•	•	
• 80 mm pneumatic lift (16 3/4" - 19 1/4")	80MM	N/C	•	•	•	
• 100 mm pneumatic lift (16 3/4" - 20 3/4")	100MM	N/C	•	•	•	
• 140 mm pneumatic lift (18" - 23 1/4")	140MM	N/C	•	•	•	
Additional Options						
• Air lumbar	AL	\$189	•	•	•	
• Air thoracic ▲	AT	\$222	•	•	•	
• Air thoracic and air lumbar ▲	ATL	\$370	N/A	•	•	
• Adjustable headrest *	AHR	\$466	•	•	•	
• Thoracic back support	THB	\$92	•	•	•	
• Back cap - fabric	PBCMBF	N/C	•	N/A	N/A	
• Neck support	NNS	\$92	N/A	N/A	N/A	
• 24 Hour Multi Tilt Mechanism **	24MT	\$387	•	•	•	

▲ Air Thoracic option is unavailable with the pull through design on the geoCentric Extra High Back.

** Warranted for 24 hour use up to a weight of 300 lbs.

* Standard on fabric upholstery. Only available on vinyl upholstery by request with a \$23 upcharge.

* Uses the fabric Nytek in black. Vinyl upholstery is not permitted..



Saffron Tall Back Dedicated Task



tCentric Hybrid Multi Tilt



airCentric Synchro Glide

OFFICE SEATING

tCentric Hybrid™

The first mesh office chair that can be called ergoCentric.

The tCentric Hybrid with Airless Cushion Technology™ combines the best attributes of the leading mesh chair with the industry leading benefits of ergoCentric's fully ergonomic upholstered chairs.

You no longer have to choose between the sleek appearance and breathability of a mesh chair and great ergonomics.

Now you can simply choose the tCentric Hybrid.



tCentric Hybrid with Airless Cushion Technology™



Optional Upholstered Seat



tCentric Hybrid with Upholstered Backrest and Seat

tCentric Hybrid™

Upholstered Backrest Accent Series

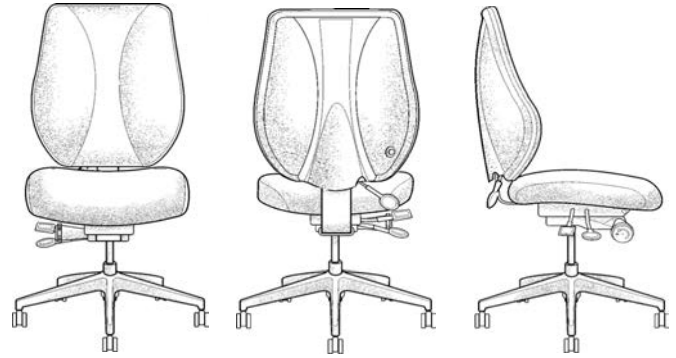

RECOMMENDED ARMS



tCentric Armrest Height & Lateral Adjustable (Midnight Black)
TCL \$509

tCentric Armrest Height & Swivel Adjustable (Midnight Black)
TC360 \$509

tCentric Armrest Height, Lateral & Swivel (Midnight Black)
TCL360 \$549

For specifications and illustrations of the tCentric armrests, see pages 69-71.

SEAT SIZE OPTIONS

Extra Small XSS \$92
(17 ½" w x 15 ½" d)

Small SS N/C
(18 ½" w x 17" d)

Plus Size PS \$92
(22" w x 19" d)

Extra Long XLS \$92
(20" w x 21" d)

Extra Deep XPS \$92
(22" w x 21" d)

For graded in upholstery choices see page 78.

LIST PRICE	List price	Midnight Black t-MBUP-ACCENT
	• Grade 1/COM (yd)	
• Grade 2		\$1,157
• Grade 3		\$1,172
• Grade 4		\$1,187
• Grade 5		\$1,202
• Leather		\$1,537

STANDARD SPECIFICATIONS	Backrest	19" w x 25"h
	• Front upholstered dual curve backrest	
• 5" Patented back height adjustment system		•
• Solid Back Cap (Midnight Black)		•
• Air Lumbar (pump)		•
Seat		•
• Dual density molded polyurethane foam		•
• Eight ply hardwood seat structure		•
• Tailored upholstery on seat pan*		20"w x 19"d
Accent Mechanism (Midnight Black)		•
• Infinite lock free float		•
• Seat height		•
• Adjustable spring tension		•
Pneumatic Lift (seat height)		•
• 125 mmLT pneumatic lift (15 ½" - 20")		•
Base		•
• 26" Glass reinforced nylon mid profile base		•
• 5 Dual wheel nylon casters 2		•
Measurements		56 lbs/11.7 cu.ft
• Boxed weight/size		

OPTIONS	Seat		Upcharge
	• Energy absorbant memory foam	EA	
• Triple density foam (adds ¼" to seat width & depth)	TDF		\$76
• Non-tailored seat pan	NTS		N/C
Base / Glides / Casters			
• 26" Polished aluminum mid-profile base	PMB		\$198
• Silver accent casters	CAC		\$113
• Dual wheel urethane casters 2	UC2		\$54
Lifts (seat height)			
• 70 mm pneumatic lift (15" - 17 ¾")	70MM		N/C
• 80 mm pneumatic lift (15 ¾" - 18 ¾")	80MM		N/C
• 100 mm pneumatic lift (16 ¾" - 20 ¾")	100MM		N/C
• 125 mm pneumatic lift (16 ¾" - 21 ¾")	125MM		N/C
• 140 mm pneumatic lift (17 ½" - 22 ¾")	140MM		N/C
• 100 mm chrome pneumatic lift (16 ¾" - 20 ¾")	100MMCH		\$40
• 125 mm chrome pneumatic lift (16 ¾" - 21 ¾")	125MMCH		\$40
• 140 mm chrome pneumatic lift (17 ½" - 22 ¾")	140MMCH		\$40
Additional Options (upholstered in Nytek)			
• Tailored adjustable headrest (Midnight Black)	AHR		\$466

* Standard on fabric upholstery. Only available on vinyl upholstery by request with a \$23 upcharge.

* Black framed chairs use the fabric Nytek in black. Vinyl upholstery is not permitted.

tCentric Hybrid™

Upholstered Backrest

Synchro Glide Series

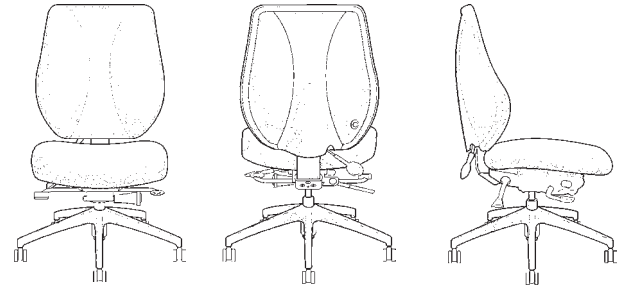

RECOMMENDED ARMS



tCentric Armrest	
Height & Lateral Adjustable	
Midnight Black TCL \$509	Light Grey TCLG \$524
Height & Swivel Adjustable	
Midnight Black TC360 \$509	Light Grey TC360G \$526
Height, Lateral & Swivel Adjustable	
Midnight Black TCL360 \$549	Light Grey TCL360G \$565

For specifications and illustrations of the tCentric armrests, see pages 69-71.

SEAT SIZE OPTIONS

- Extra Small XSS** \$92
(17 ½" w x 15 ½" d)
- Small SS** N/C
(18 ½" w x 17" d)
- Plus Size PS** \$92
(22" w x 19" d)
- Extra Long XLS** \$92
(20" w x 21" d)
- Extra Deep XPS** \$92
(22" w x 21" d)

For graded in upholstery choices see page 78.

LIST PRICE	List Price	Midnight Black	Light Grey
		t-MBUP-SG	t-LGUP-SGG
	• Grade 1/COM (yd)	\$1,455 (1)	\$1,504 (1)
	• Grade 2	\$1,470	\$1,519
	• Grade 3	\$1,485	\$1,534
	• Grade 4	\$1,500	\$1,549
	• Grade 5	\$1,515	\$1,564
	• Leather	\$1,850	\$1,899

STANDARD SPECIFICATIONS	Backrest	Midnight Black	Light Grey
	• Front upholstered dual curve backrest	19" w x 25"h	19" w x 25"h
	• 5" Patented back height adjustment system	•	•
	• Solid Back Cap	•	•
	• Air Lumbar (pump)	•	•
	Seat		
	• Dual density molded polyurethane foam		•
	• Eight ply hardwood seat structure		•
	• Tailored upholstery on seat pan*		20" w x 19" d
	Synchro Glide Mechanism		
	• Seat tilt lock out	•	•
	• Free float	•	•
	• Independent back angle adjustment	•	•
	• Synchro 2:1 ratio	•	•
	• Adjustable spring tension	•	•
	• 2 ½" Depth adjustable seat slider	•	•
	Pneumatic Lift (seat height)		
	• 125 mmLT pneumatic lift (17" - 21 ½")	•	•
	Base		
	• 26" Glass reinforced nylon mid profile base	•	•
	• 5 Dual wheel nylon casters 2	•	•
	Measurements		
	• Boxed weight/size	56 lbs/11.7 cu.ft	

OPTIONS	Seat		Upcharge	Midnight Black	Light Grey
	• Energy Absorbant Memory Foam	EA	\$92	•	•
	• Triple Density Foam (adds ¼" to seat width & depth)	TDF	\$76	•	•
	• Non-tailored seat pan	NTS	N/C	•	•
	Base/Glides/Casters				
	• 26" Polished aluminum mid-profile base	PMB	\$198	•	•
	• Silver accent casters	CAC	\$113	•	•
	• Dual wheel urethane casters 2		\$54	UC2	GUC2
	Lifts (seat height)				
	• 70 mm pneumatic lift (16 ½" - 19 ¼")		N/C	70MM	G70MM
	• 80 mm pneumatic lift (17 ¼" - 20 ¼")		N/C	80MM	G80MM
	• 100 mm pneumatic lift (17 ¾" - 21 ¾")		N/C	100MM	G100MM
	• 125 mm pneumatic lift (18 ¼" - 22 ¾")		N/C	125MM	G125MM
	• 140 mm pneumatic lift (19" - 24 ¼")		N/C	140MM	G140MM
	• 100 mm chrome pneumatic lift (17 ¾" - 21 ¾")	100MMCH	\$40	•	•
	• 125 mm chrome pneumatic lift (18 ¼" - 22 ¾")	125MMCH	\$40	•	•
	• 140 mm chrome pneumatic lift (19" - 24 ¼")	140MMCH	\$40	•	•
	Additional Options (upholstered in Nytek)				
	• Midnight Black Tailored adjustable headrest*		\$466	AHR	N/A
	• Light Grey Tailored adjustable headrest*		\$506	N/A	AHRG

Note: Mixing of Midnight Black and Light Grey components is not an option.

* Standard on fabric upholstery. Only available on vinyl upholstery by request with a \$23 upcharge.

* Black framed chairs use the fabric Nytek in black. Grey framed chairs use Nytek in light grey. Vinyl upholstery is not permitted.

tCentric Hybrid™

Upholstered Backrest Multi Tilt Series

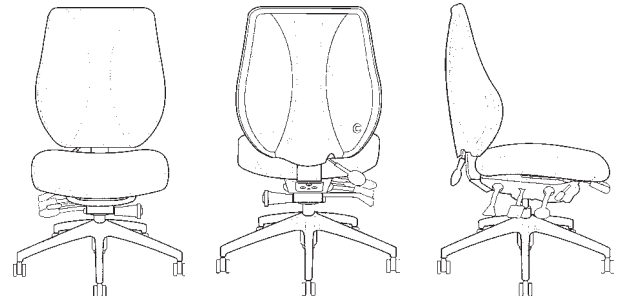

RECOMMENDED ARMS



tCentric Armrest	
Height & Lateral Adjustable	
Midnight Black TCL \$509	Light Grey TCLG \$524
Height & Swivel Adjustable	
Midnight Black TC360 \$509	Light Grey TC360G \$526
Height, Lateral & Swivel Adjustable	
Midnight Black TCL360 \$549	Light Grey TCL360G \$565

For specifications and illustrations of the tCentric armrests, see pages 69-71.

SEAT SIZE OPTIONS

- Extra Small XSS** \$92
(17 ½" w x 15 ½" d)
- Small SS** N/C
(18 ½" w x 17" d)
- Plus Size PS** \$92
(22" w x 19" d)
- Extra Long XLS** \$92
(20" w x 21" d)
- Extra Deep XPS** \$92
(22" w x 21" d)

For graded in upholstery choices see page 78.

LIST PRICE	List Price	Midnight Black	Light Grey
		t-MBUP-MT	t-LGUP-MTG
	• Grade 1/COM (yd)	\$1,343 (1)	\$1,394 (1)
	• Grade 2	\$1,358	\$1,409
	• Grade 3	\$1,373	\$1,424
	• Grade 4	\$1,388	\$1,439
	• Grade 5	\$1,403	\$1,454
	• Leather	\$1,738	\$1,789

STANDARD SPECIFICATIONS	Backrest	Midnight Black	Light Grey
		<ul style="list-style-type: none"> • Front upholstered dual curve backrest • 5" Patented back height adjustment system • Solid Back Cap • Air Lumbar (pump) 	19" w x 25" h
	Seat		
	<ul style="list-style-type: none"> • Dual density molded polyurethane foam • Eight ply hardwood seat structure • Tailored upholstery on seat pan* 		20" w x 19" d
	Multi Tilt Mechanism		
	<ul style="list-style-type: none"> • Infinite lock free float • Back angle adjustment • Adjustable spring tension • Infinite forward tilt lock out • 2 ½" Depth adjustable seat slider 	•	•
	Pneumatic Lift (seat height)		
	• 125 mmLT pneumatic lift (16" - 20 ½")	•	•
	Base		
	<ul style="list-style-type: none"> • 26" Glass reinforced nylon mid profile base • 5 Dual wheel nylon casters 2 	•	•
	Measurements		
	• Boxed weight/size	56 lbs/11.7 cu.ft	

OPTIONS	Seat	Upcharge	Midnight Black	Light Grey	
			<ul style="list-style-type: none"> • Energy Absorbant Memory Foam • Triple Density Foam (adds ¼" to seat width & depth) • Non-tailored seat pan 	EA TDF NTS	\$92 \$76 N/C
	Base/Glides/Casters				
	• 26" Polished aluminum mid-profile base	PMB	\$198	•	•
	• Silver accent casters	CAC	\$113	•	•
	• Dual wheel urethane casters 2		\$54	UC2	GUC2
	Lifts (seat height)				
	• 70 mm pneumatic lift (15 ½" - 18 ¾")		N/C	70MM	G70MM
	• 80 mm pneumatic lift (16 ¾" - 19 ¾")		N/C	80MM	G80MM
	• 100 mm pneumatic lift (16 ¾" - 20 ¾")		N/C	100MM	G100MM
	• 125 mm pneumatic lift (17 ¾" - 21 ¾")		N/C	125MM	G125MM
	• 140 mm pneumatic lift (18" - 23 ¾")		N/C	140MM	G140MM
	• 100 mm chrome pneumatic lift (16 ¾" - 20 ¾")	100MMCH	\$40	•	•
	• 125 mm chrome pneumatic lift (17 ¾" - 21 ¾")	125MMCH	\$40	•	•
	• 140 mm chrome pneumatic lift (18" - 23 ¾")	140MMCH	\$40	•	•
	Additional Options (upholstered in Nytek)				
	• Midnight Black Tailored adjustable headrest*		\$466	AHR	N/A
	• Light Grey Tailored adjustable headrest*		\$506	N/A	AHRG

Note: Mixing of Midnight Black and Light Grey components is not an option.

* Standard on fabric upholstery. Only available on vinyl upholstery by request with a \$23 upcharge.

* Black framed chairs use the fabric Nytek in black. Grey framed chairs use Nytek in light grey. Vinyl upholstery is not permitted.

tCentric Hybrid™

Upholstered Backrest

Synchro Tilt Series

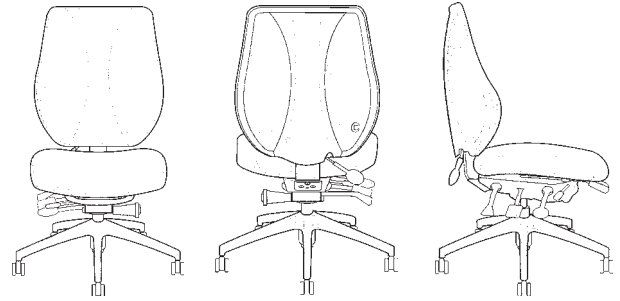

RECOMMENDED ARMS



tCentric Armrest
Height & Lateral Adjustable
Midnight Black TCL \$509
Height & Swivel Adjustable
Midnight Black TC360 \$509
Height, Lateral & Swivel Adjustable
Midnight Black TCL360 \$549

For specifications and illustrations of the tCentric armrests, see pages 69-71.

SEAT SIZE OPTIONS

- Extra Small XSS** \$92
(17 ½" w x 15 ½" d)
- Small SS** N/C
(18 ½" w x 17" d)
- Plus Size PS** \$92
(22" w x 19" d)
- Extra Long XLS** \$92
(20" w x 21" d)
- Extra Deep XPS** \$92
(22" w x 21" d)

For graded in upholstery choices see page 78.

LIST PRICE	List Price	Midnight Black
	<ul style="list-style-type: none"> • Grade 1/COM (yd) • Grade 2 • Grade 3 • Grade 4 • Grade 5 • Leather 	t-MBUP-ST

STANDARD SPECIFICATIONS	Backrest	Midnight Black	
	<ul style="list-style-type: none"> • Front upholstered dual curve backrest • 5" Patented back height adjustment system • Solid Back Cap • Air Lumbar (pump) 	19" w x 25"h	• • •
Seat	<ul style="list-style-type: none"> • Dual density molded polyurethane foam • Eight ply hardwood seat structure • Tailored upholstery on seat pan* 	20" w x 19" d	• •
Synchro Tilt Mechanism	<ul style="list-style-type: none"> • Seat tilt lock out • Free float • Synchro 2:1 ratio • Adjustable spring tension • 2" Depth adjustable seat slider 		• • • • •
Pneumatic Lift (seat height)	<ul style="list-style-type: none"> • 125 mmLT pneumatic lift (16" - 20 ½") 		•
Base	<ul style="list-style-type: none"> • 26" Glass reinforced nylon mid profile base • 5 Dual wheel nylon casters 2 		• •
Measurements	<ul style="list-style-type: none"> • Boxed weight/size 		56 lbs/11.7 cu.ft

OPTIONS	Seat	Upcharge	Midnight Black	
	<ul style="list-style-type: none"> • Energy Absorbant Memory Foam • Triple Density Foam (adds ¼" to seat width & depth) • Non-tailored seat pan 	EA TDF NTS	\$92 \$76 N/C	• • •
Base/Glides/Casters	<ul style="list-style-type: none"> • 26" Polished aluminum mid-profile base • Silver accent casters • Dual wheel urethane casters 2 	PMB CAC	\$198 \$113 \$54	• • UC2
Lifts (seat height)	<ul style="list-style-type: none"> • 70 mm pneumatic lift (15 ½" - 18 ¾") • 80 mm pneumatic lift (16 ¾" - 19 ¾") • 100 mm pneumatic lift (16 ¾" - 20 ¾") • 125 mm pneumatic lift (17 ¼" - 21 ¾") • 140 mm pneumatic lift (18" - 23 ¼") • 100 mm chrome pneumatic lift (16 ¾" - 20 ¾") • 125 mm chrome pneumatic lift (17 ¼" - 21 ¾") • 140 mm chrome pneumatic lift (18" - 23 ¼") 		N/C N/C N/C N/C N/C \$40 \$40 \$40	70MM 80MM 100MM 125MM 140MM • • •
Additional Options (upholstered in Nytek)	<ul style="list-style-type: none"> • Midnight Black Tailored adjustable headrest* • Light Grey Tailored adjustable headrest* 		\$466 \$506	AHR N/A

Note: Mixing of Midnight Black and Light Grey components is not an option.
 * Standard on fabric upholstery. Only available on vinyl upholstery by request with a \$23 upcharge.
 * Black framed chairs use the fabric Nytek in black. Grey framed chairs use Nytek in light grey. Vinyl upholstery is not permitted.

tCentric Hybrid™

Upholstered Backrest

Boardroom Series

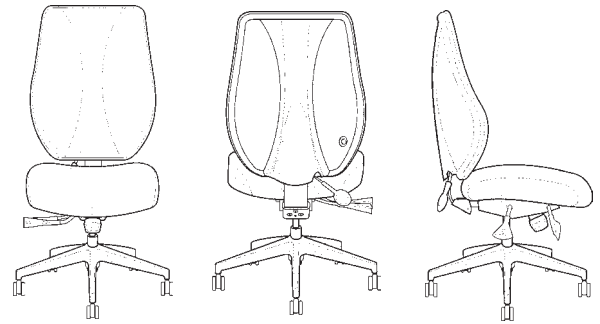

RECOMMENDED ARMS



tCentric Armrest	
Height & Lateral Adjustable	
Midnight Black TCL \$509	Light Grey TCLG \$524
Height & Swivel Adjustable	
Midnight Black TC360 \$509	Light Grey TC360G \$526
Height, Lateral & Swivel Adjustable	
Midnight Black TCL360 \$549	Light Grey TCL360G \$565

For specifications and illustrations of the tCentric armrests, see pages 69-71.

SEAT SIZE OPTIONS

- Extra Small XSS** \$92
(17 ½" w x 15 ½" d)
- Small SS** N/C
(18 ½" w x 17" d)
- Plus Size PS** \$92
(22" w x 19" d)
- Extra Long XLS** \$92
(20" w x 21" d)
- Extra Deep XPS** \$92
(22" w x 21" d)

For graded in upholstery choices see page 78.

LIST PRICE	List Price	Midnight Black	Light Grey
		t-MBUP-BR	t-LGUP BRG
	• Grade 1/COM (yd)	\$1,081 (1)	\$1,122 (1)
	• Grade 2	\$1,096	\$1,137
	• Grade 3	\$1,111	\$1,152
	• Grade 4	\$1,126	\$1,167
	• Grade 5	\$1,141	\$1,182
	• Leather	\$1,476	\$1,517

STANDARD SPECIFICATIONS	Backrest	Midnight Black	Light Grey
		<ul style="list-style-type: none"> • Front upholstered dual curve backrest • 5" Patented back height adjustment system • Solid Back Cap • Air Lumbar (pump) 	19" w x 25"h
	Seat		
	<ul style="list-style-type: none"> • Dual density molded polyurethane foam • Eight ply hardwood seat structure • Tailored upholstery on seat pan* 		20" w x 19" d
	Boardroom Mechanism		
	<ul style="list-style-type: none"> • Single lock free float • Seat height • Adjustable spring tension 	•	•
	Pneumatic Lift (seat height)		
	<ul style="list-style-type: none"> • 125 mm pneumatic lift (16 ¼" - 20 ¾") 	•	•
	Base		
	<ul style="list-style-type: none"> • 26" Glass reinforced nylon mid profile base • 5 Dual wheel nylon casters 2 	•	•
	Measurements		
	<ul style="list-style-type: none"> • Boxed weight/size 	56 lbs/11.7 cu.ft	

OPTIONS	Seat	Upcharge	Midnight Black	Light Grey	
			<ul style="list-style-type: none"> • Energy Absorbant Memory Foam • Triple Density Foam (adds ¼" to seat width & depth) • Non-tailored seat pan 	EA	\$92
		TDF	\$76	•	•
		NTS	N/C	•	•
	Base/Glides/Casters				
	<ul style="list-style-type: none"> • 26" Polished aluminum mid-profile base • Silver accent casters • Dual wheel urethane casters 2 	PMB	\$198	•	•
		CAC	\$113	•	•
			\$54	UC2	GUC2
	Lifts (seat height)				
	<ul style="list-style-type: none"> • 140 mm pneumatic lift (17" - 22 ¼") • 125 mm chrome pneumatic lift (16 ¼" - 20 ¾") • 140 mm chrome pneumatic lift (17" - 22 ¼") 		N/C	140MM	G140MM
		125MMCH	\$40	•	•
		140MMCH	\$40	•	•
	Additional Options (upholstered in Nytek)				
	<ul style="list-style-type: none"> • Midnight Black Tailored adjustable headrest* • Light Grey Tailored adjustable headrest* 		\$466	AHR	N/A
			\$506	N/A	AHRG

Note: Mixing of Midnight Black and Light Grey components is not an option.

* Standard on fabric upholstery. Only available on vinyl upholstery by request with a \$23 upcharge.

* Black framed chairs use the fabric Nytek in black. Grey framed chairs use Nytek in light grey. Vinyl upholstery is not permitted.

tCentric Hybrid™

Upholstered Backrest Counter Height Series

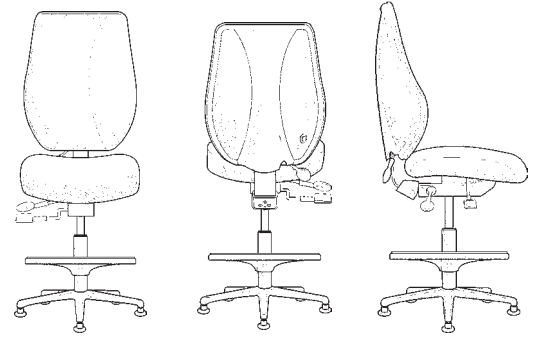

RECOMMENDED ARMS



tCentric Armrest	
Height & Lateral Adjustable	
Midnight Black TCL \$509	Light Grey TCLG \$524
Height & Swivel Adjustable	
Midnight Black TC360 \$509	Light Grey TC360G \$526
Height, Lateral & Swivel Adjustable	
Midnight Black TCL360 \$549	Light Grey TCL360G \$565

For specifications and illustrations of the tCentric armrests, see pages 69-71.

SEAT SIZE OPTIONS

- Extra Small XSS** \$92
(17 ½" w x 15 ½" d)
- Small SS** N/C
(18 ½" w x 17" d)
- Plus Size PS** \$92
(22" w x 19" d)
- Extra Long XLS** \$92
(20" w x 21" d)
- Extra Deep XPS** \$92
(22" w x 21" d)

For graded in upholstery choices see page 78.

LIST PRICE	List Price	Midnight Black t-MBUP-CH	Light Grey t-LGUP-CHG
	• Grade 1/COM (yd)	\$1,366 (1)	\$1,415 (1)
	• Grade 2	\$1,381	\$1,430
	• Grade 3	\$1,396	\$1,445
	• Grade 4	\$1,411	\$1,460
	• Grade 5	\$1,426	\$1,475
	• Leather	\$1,761	\$1,810

STANDARD SPECIFICATIONS	Backrest	Midnight Black	Light Grey
	• Front upholstered dual curve backrest	19" w x 25"h	19" w x 25"h
	• 5" Patented back height adjustment system	•	•
	• Solid Back Cap	•	•
	• Air Lumbar (pump)	•	•
	Seat		
	• Dual density molded polyurethane foam	•	•
	• Eight ply hardwood seat structure	•	•
	• Tailored upholstery on seat pan*	20" w x 19" d	
	Counter Height Mechanism		
• Independent back angle adjustment	•	•	
• Fixed seat	•	•	
• Seat height	•	•	
Pneumatic Lift			
• 200 mm pneumatic lift (23" - 29 ½")	•	•	
Base			
• 26" Glass reinforced nylon mid profile base	•	•	
• 20" diameter aluminum, height adjustable footring; 1 ¾" foot platform	•	•	
• 2 ¼" Glides	•	•	
Measurements			
• Boxed weight/size	56 lbs/6.7 cu.ft		

OPTIONS	Seat	Upcharge	Midnight Black	Light Grey
	• Energy Absorbant Memory Foam	EA \$92	•	•
	• Triple Density Foam (adds ¾" to seat width & depth)	TDF \$76	•	•
	• Non-tailored seat pan	NTS N/C	•	•
	Base/Glides/Casters			
	• Lock-on urethane casters	LON \$188	•	•
	• Lock-off urethane casters	LOF \$89	•	•
	• Dual wheel nylon casters 2	N/C	NC2	GNC2
	• Dual wheel urethane casters 2	\$54	UC2	GUC2
	• Single wheel nylon casters	SW \$74	•	•
	• Single wheel urethane casters	SWU \$82	•	•
	Lifts (seat height)			
	• 157 mm pneumatic lift (18 ¾" - 23 ¾")	N/C	157MM	G157MM
	• 267 mm pneumatic lift (24 ¾" - 34 ¾")	\$8	267MM	G267MM
	Mechanisms			
• Modified Multi Tilt Mechanism (Seat slider, height and back angle adjustment only)	MT \$171	•	•	
• Dedicated Task 2 Mechanism	DT2 N/C	•	•	
Additional Options (upholstered in Nytek)				
• Midnight Black Tailored adjustable headrest*	\$466	AHR	N/A	
• Light Grey Tailored adjustable headrest*	\$506	N/A	AHRG	

* Standard on fabric upholstery. Only available on vinyl upholstery by request with a \$23 upcharge.

* Black framed chairs use the fabric Nytek in black. Grey framed chairs use Nytek in light grey. Vinyl upholstery is not permitted.



tCentric Hybrid™

All Mesh Synchro Glide Series

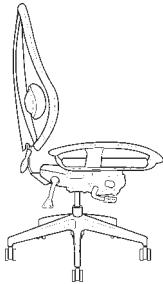
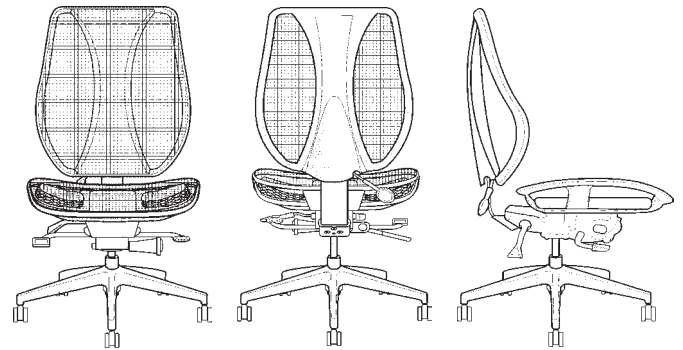

Shown with optional tCentric Lumbar Support

RECOMMENDED ARMS



The All Mesh tCentric Hybrid can only use the tCentric Armrests.

tCentric Armrest	
Height & Lateral Adjustable	
Midnight Black TCL \$509	Light Grey TCLG \$524
Height & Swivel Adjustable	
Midnight Black TC360 \$509	Light Grey TC360G \$526
Height, Lateral & Swivel Adjustable	
Midnight Black TCL360 \$549	Light Grey TCL360G \$565

For specifications and illustrations of the tCentric armrests, see pages 69-71.

SEAT SIZE OPTIONS

- Small Mesh Seat [MB]**
(20" w x 16 ½" d)
TMBSS N/C
- Extra Long Mesh Seat [MB]**
(21" w x 21½" d)
TMBXLS \$66
- Small Mesh Seat [LG]**
(20" w x 16 ½" d)
TLGMSS N/C
- Extra Long Mesh Seat [LG]**
(21" w x 21½" d)
TLGMXLS \$105

LIST PRICE	List Price	Midnight Black	Light Grey
		t-MBMESH-SG	t-LGMESH-SGG
	• All Mesh	\$1,788	\$1,829

STANDARD SPECIFICATIONS	Backrest	Midnight Black	Light Grey
	<ul style="list-style-type: none"> Dual curve mesh backrest (19" w x 25"h) 5" Patented back height adjustment system 	•	•
Seat	<ul style="list-style-type: none"> Mesh seat with 30% glass filled Nylon frame (21" w x 18 ½" d) Airless Cushion Technology 	•	•
Synchro Glide Mechanism	<ul style="list-style-type: none"> Seat tilt lock out Free float Independent back angle adjustment Synchro 2:1 ratio Adjustable spring tension 1 ¾" Depth adjustable seat slider 	•	•
Pneumatic Lift (seat height)	<ul style="list-style-type: none"> 125 mmLT pneumatic lift (17 ¼" - 21 ¾") 	•	•
Base	<ul style="list-style-type: none"> 26" Glass reinforced nylon mid profile base 5 Dual wheel nylon casters 2 	•	•
Measurements	<ul style="list-style-type: none"> Boxed weight/size 	46.4 lbs/11.7 cu.ft	

OPTIONS	Base/Glides/Casters	Upcharge	Midnight Black	Light Grey	
	<ul style="list-style-type: none"> 26" Polished aluminum mid-profile base Silver accent casters Dual wheel urethane casters 2 	PMB CAC	\$198 \$113 \$54	• • UC2	• • GUC2
Lifts (seat height)	<ul style="list-style-type: none"> 70 mm pneumatic lift (16 ¼" - 19") 80 mm pneumatic lift (17" - 20") 100 mm pneumatic lift (17 ½" - 21 ½") 125 mm pneumatic lift (18" - 22 ½") 140 mm pneumatic lift (19 ¼" - 24 ½") 100 mm chrome pneumatic lift (17 ½" - 21 ½") 125 mm chrome pneumatic lift (18" - 22 ½") 140 mm chrome pneumatic lift (19 ¼" - 24 ½") 	N/C N/C N/C N/C N/C 100MMCH 125MMCH 140MMCH	\$40 \$40 \$40	• • • • • • • •	G70MM G80MM G100MM G125MM G140MM
Additional Options (upholstered in Nytek)	<ul style="list-style-type: none"> tCentric Lumbar support (12" w x 6" h)* tCentric Air Lumbar 1 (hand pump)* tCentric Air Lumbar 2 (built-in)* Midnight Black Tailored adjustable headrest* Light Grey Tailored adjustable headrest* 	\$135 \$277 \$277 \$466 \$506	TLS TLSAL TALSC AHR N/A	TLSG TLSALG TALSCG N/A AHRG	

Note: Mixing of Midnight Black and Light Grey components is not an option.
* Black framed chairs use the fabric Nytek in black. Grey framed chairs use Nytek in light grey. Vinyl upholstery is not permitted.



tCentric Hybrid™

All Mesh Boardroom Series

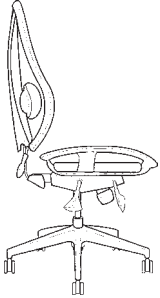

Shown with optional tCentric Lumbar Support

RECOMMENDED ARMS



The All Mesh tCentric Hybrid can only use the tCentric Armrests.

tCentric Armrest	
Height & Lateral Adjustable	
Midnight Black TCL \$509	Light Grey TCLG \$524
Height & Swivel Adjustable	
Midnight Black TC360 \$509	Light Grey TC360G \$526
Height, Lateral & Swivel Adjustable	
Midnight Black TCL360 \$549	Light Grey TCL360G \$565

For specifications and illustrations of the tCentric armrests, see pages 69-71.

SEAT SIZE OPTIONS

- Small Mesh Seat [MB]**
(20" w x 16 ½" d)
TMBMSS N/C
- Extra Long Mesh Seat [MB]**
(21" w x 21½" d)
TMBMXLS \$66
- Small Mesh Seat [LG]**
(20" w x 16 ½" d)
TLGMSS N/C
- Extra Long Mesh Seat [LG]**
(21" w x 21½" d)
TLGMXLS \$105

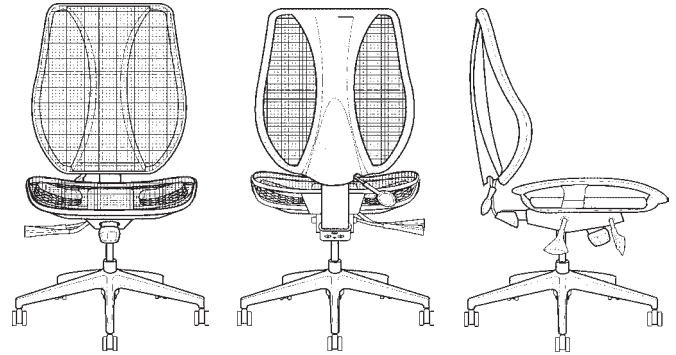

LIST PRICE	List Price	Midnight Black	Light Grey
		t-MBMESH-BR	t-LGMESH-BRG
	• All Mesh	\$1,401	\$1,450

STANDARD SPECIFICATIONS	Backrest	Midnight Black	Light Grey
	• Dual curve mesh backrest (19" w x 25"h)	•	•
• 5" Patented back height adjustment system	•	•	
Seat	• Mesh seat with 30% glass filled nylon frame (21" w x 18 ½" d)	•	•
• Airless cushion technology	•	•	
Boardroom Mechanism	• Single lock free float	•	•
• Seat height	•	•	
• Adjustable spring tension	•	•	
• 125 mm pneumatic lift (16" - 20 ½")	•	•	
Base	• 26" Glass reinforced nylon mid profile base	•	•
• 5 Dual wheel nylon casters 2	•	•	
Measurements	• Boxed weight/size	46.4 lbs/11.7 cu.ft	

OPTIONS	Base/Glides/Casters	Upcharge	Midnight Black	Light Grey
	• 26" Polished aluminum mid-profile base	PMB	\$198	•
• Silver accent casters	CAC	\$113	•	•
• Dual wheel urethane caster 2		\$54	UC2	GUC2
Lifts (seat height)	• 140 mm pneumatic lift (18" - 23 ¼")	N/C	140MM	G140MM
• 125 mm chrome pneumatic lift (16" - 20 ½")	125MMCH	\$40	•	•
• 140 mm chrome pneumatic lift (18" - 23 ¼")	140MMCH	\$40	•	•
Additional Options (upholstered in Nytek)	• tCentric Lumbar support (12" w x 6" h)*	\$135	TLS	TLSG
• tCentric Air Lumbar 1 (hand pump)*		\$277	TLSAL	TLSALG
• tCentric Air Lumbar 2 (built-in)*		\$277	TALSC	TALSCG
• Midnight Black Tailored adjustable headrest*		\$466	AHR	N/A
• Light Grey Tailored adjustable headrest*		\$506	N/A	AHRG

Note: Mixing of Midnight Black and Light Grey components is not an option.

* Black framed chairs use the fabric Nytek in black. Grey framed chairs use Nytek in light grey. Vinyl upholstery is not permitted.



tCentric Hybrid™

Foam and Fabric Seat Accent Series

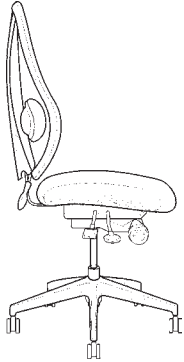

Shown with optional
tCentric Lumbar Support

RECOMMENDED ARMS



tCentric Armrest Height
& Lateral Adjustable
(Midnight Black)

TCL \$509

tCentric Armrest Height &
Swivel Adjustable
(Midnight Black)

TC360 \$509

tCentric Armrest Height,
Lateral & Swivel
(Midnight Black)

TCL360 \$549

For specifications and
illustrations of the tCentric
armrests, see pages 69-71.

SEAT SIZE OPTIONS

Extra Small XSS \$92
(17 ½" w x 15 ½" d)

Small SS N/C
(18 ½" w x 17" d)

Plus Size PS \$92
(22" w x 19" d)

Extra Long XLS \$92
(20" w x 21" d)

Extra Deep XPS \$92
(22" w x 21" d)

For graded in upholstery
choices see page 78.

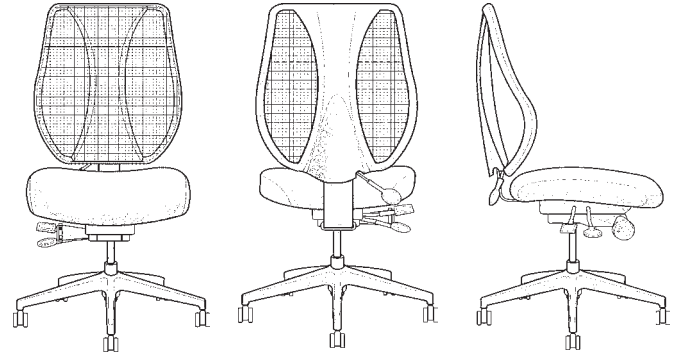

LIST PRICE	List price	Midnight Black
		t-ACCENT
	• Grade 1/COM (yd)	\$1,221 (1)
	• Grade 2	\$1,233
	• Grade 3	\$1,245
	• Grade 4	\$1,257
	• Grade 5	\$1,269
	• New! Nymatrix™ (Nymatrix is for use on the seat only).**	\$1,305
	• Leather	\$1,500

STANDARD SPECIFICATIONS	Backrest (Midnight Black)	Midnight Black
		• 5" Patented back height adjustment system • Dual curve mesh backrest
	Seat	
	• Dual density molded polyurethane foam • Eight ply hardwood seat structure • Tailored upholstery on seat pan*	• • 20"w x 19"d
	Accent Mechanism (Midnight Black)	
	• Infinite lock free float • Seat height • Adjustable spring tension	• • •
	Pneumatic Lift (seat height)	
	• 125 mmLT pneumatic lift (15 ½" - 20")	•
	Base	
	• 26" Glass reinforced nylon mid profile base • 5 Dual wheel nylon casters 2	• •
	Measurements	
	• Boxed weight/size	56 lbs/11.7 cu.ft

OPTIONS	Seat		Upcharge
			• Energy absorbant memory foam
	• Triple density foam (adds ¼" to seat width & depth)	TDF	\$76
	• Non-tailored seat pan	NTS	N/C
	Base/Glides/Casters		
	• 26" Polished aluminum mid-profile base	PMB	\$198
	• Silver accent casters	CAC	\$113
	• Dual wheel urethane caster 2	UC2	\$54
	Lifts (seat height)		
	• 70 mm pneumatic lift (15" - 17 ¾")	70MM	N/C
	• 80 mm pneumatic lift (15 ¾" - 18 ¾")	80MM	N/C
	• 100 mm pneumatic lift (16 ¼" - 20 ¼")	100MM	N/C
	• 125 mm pneumatic lift (16 ¾" - 21")	125MM	N/C
	• 140 mm pneumatic lift (17 ½" - 22 ¾")	140MM	N/C
	• 100 mm chrome pneumatic lift (16 ¼" - 20 ¼")	100MMCH	\$40
	• 125 mm chrome pneumatic lift (16 ¾" - 21")	125MMCH	\$40
	• 140 mm chrome pneumatic lift (17 ½" - 22 ¾")	140MMCH	\$40
	Additional Options (upholstered in Nytek)		
	• tCentric Lumbar support (12"w x 6"h)*	TLS	\$135
	• tCentric Air Lumbar 1 (hand pump)*	TLSAL	\$277
	• tCentric Air Lumbar 2 (built-in)*	TALSC	\$277
	• Tailored adjustable headrest (Midnight Black) *	AHR	\$466

**Specifying Nymatrix on a seat with a different backrest upholstery is considered Combination Upholstery. To calculate the price of the chair, add the price for a full chair in the grade of the backrest material and a full chair in Nymatrix and divide by 2.

* Standard on fabric upholstery. Only available on vinyl upholstery by request with a \$23 upcharge.

* Black framed chairs use the fabric Nytek in black. Grey framed chairs use Nytek in light grey. Vinyl upholstery is not permitted.

tCentric Hybrid™

Foam and Fabric Seat

Synchro Glide Series

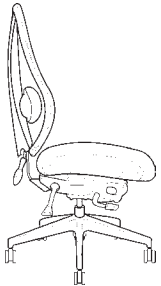
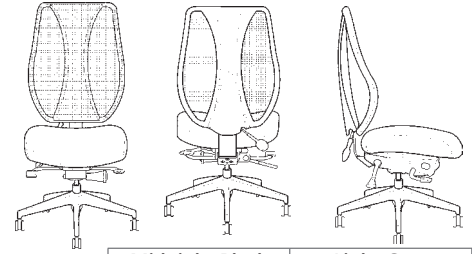

Shown with optional tCentric Lumbar Support

RECOMMENDED ARMS



tCentric Armrest	
Height & Lateral Adjustable	
Midnight Black TCL \$509	Light Grey TCLG \$524
Height & Swivel Adjustable	
Midnight Black TC360 \$509	Light Grey TC360G \$526
Height, Lateral & Swivel Adjustable	
Midnight Black TCL360 \$549	Light Grey TCL360G \$565

For specifications and illustrations of the tCentric armrests, see pages 69-71.

SEAT SIZE OPTIONS

- Extra Small XSS** \$92 (17 ½" w x 15 ½" d)
- Small SS** N/C (18 ½" w x 17" d)
- Plus Size PS** \$92 (22" w x 19" d)
- Extra Long XLS** \$92 (20" w x 21" d)
- Extra Deep XPS** \$92 (22" w x 21" d)

For graded in upholstery choices see page 78.

LIST PRICE	List Price	Midnight Black	Light Grey
		t-SG	t-SGG
	• Grade 1/COM (yd)	\$1,531 (1)	\$1,578 (1)
	• Grade 2	\$1,543	\$1,590
	• Grade 3	\$1,555	\$1,602
	• Grade 4	\$1,567	\$1,614
	• Grade 5	\$1,579	\$1,626
	• New! Nymatrix (Nymatrix is for use on the seat only).**	\$1,615	\$1,662
	• Leather	\$1,810	\$1,857

STANDARD SPECIFICATIONS	Backrest	Midnight Black	Light Grey
		• Dual curve mesh backrest (19" w x 25"h)	•
	• 5" Patented back height adjustment system	•	•
	Seat		
	• Dual density molded polyurethane foam		•
	• Eight ply hardwood seat structure		20" w x 19" d
	• Tailored upholstery on seat pan*		
	Synchro Glide Mechanism		
	• Seat tilt lock out	•	•
	• Free float	•	•
	• Independent back angle adjustment	•	•
	• Synchro 2:1 ratio	•	•
	• Adjustable spring tension	•	•
	• 2 ½" Depth adjustable seat slider	•	•
	Pneumatic Lift (seat height)		
	• 125 mmLT pneumatic lift (17" - 21 ½")	•	•
	Base		
	• 26" Glass reinforced nylon mid profile base	•	•
	• 5 Dual wheel nylon casters 2	•	•
	Measurements		
	• Boxed weight/size	56 lbs/11.7 cu.ft	

OPTIONS	Seat	Upcharge	Midnight Black	Light Grey	
			• Energy Absorbant Memory Foam	EA	\$92
	• Triple Density Foam (adds ¼" to seat width & depth)	TDF	\$76	•	•
	• Non-tailored seat pan	NTS	N/C	•	•
	Base/Glides/Casters				
	• 26" Polished aluminum mid-profile base	PMB	\$198	•	•
	• Silver accent casters	CAC	\$113	•	•
	• Dual wheel urethane casters 2		\$54	UC2	GUC2
	Lifts (seat height)				
	• 70 mm pneumatic lift (16 ½" - 19 ¼")		N/C	70MM	G70MM
	• 80 mm pneumatic lift (17 ¼" - 20 ¼")		N/C	80MM	G80MM
	• 100 mm pneumatic lift (17 ¾" - 21 ¾")		N/C	100MM	G100MM
	• 125 mm pneumatic lift (18 ¼" - 22 ¾")		N/C	125MM	G125MM
	• 140 mm pneumatic lift (19" - 24 ¼")		N/C	140MM	G140MM
	• 100 mm chrome pneumatic lift (17 ¾" - 21 ¾")	100MMCH	\$40	•	•
	• 125 mm chrome pneumatic lift (18 ¼" - 22 ¾")	125MMCH	\$40	•	•
	• 140 mm chrome pneumatic lift (19" - 24 ¼")	140MMCH	\$40	•	•
	Additional Options (upholstered in Nytek)				
	• tCentric Lumbar support (12" w x 6" h)*		\$135	TLS	TLSG
	• tCentric Air Lumbar 1 (hand pump)*		\$277	TLSAL	TLSALG
	• tCentric Air Lumbar 2 (built-in)*		\$277	TALSC	TALSCG
	• Midnight Black Tailored adjustable headrest*		\$466	AHR	N/A
	• Light Grey Tailored adjustable headrest*		\$506	N/A	AHRG

Note: Mixing of Midnight Black and Light Grey components is not an option.

**Specifying Nymatrix on a seat with a different backrest upholstery is considered Combination Upholstery. To calculate the price of the chair, add the price for a full chair in the grade of the backrest material and a full chair in Nymatrix and divide by 2.

* Standard on fabric upholstery. Only available on vinyl upholstery by request with a \$23 upcharge.

* Black framed chairs use the fabric Nytek in black. Grey framed chairs use Nytek in light grey. Vinyl upholstery is not permitted.



tCentric Hybrid™

Foam and Fabric Seat

Multi Tilt Series

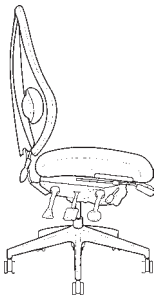
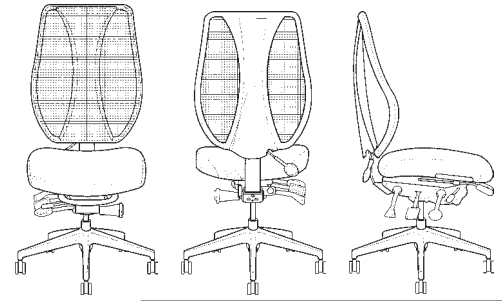

Shown with optional tCentric Lumbar Support

RECOMMENDED ARMS



tCentric Armrest	
Height & Lateral Adjustable	
Midnight Black TCL \$509	Light Grey TCLG \$524
Height & Swivel Adjustable	
Midnight Black TC360 \$509	Light Grey TC360G \$526
Height, Lateral & Swivel Adjustable	
Midnight Black TCL360 \$549	Light Grey TCL360G \$565

For specifications and illustrations of the tCentric armrests, see pages 69-71.

SEAT SIZE OPTIONS

- Extra Small XSS** \$92
(17 1/2" w x 15 1/2" d)
- Small SS** N/C
(18 1/2" w x 17" d)
- Plus Size PS** \$92
(22" w x 19" d)
- Extra Long XLS** \$92
(20" w x 21" d)
- Extra Deep XPS** \$92
(22" w x 21" d)

For graded in upholstery choices see page 78.

LIST PRICE	List Price	Midnight Black	Light Grey
		t-MT	t-MTG
	• Grade 1/COM (yd)	\$1,422 (1)	\$1,470 (1)
	• Grade 2	\$1,434	\$1,482
	• Grade 3	\$1,446	\$1,494
	• Grade 4	\$1,458	\$1,506
	• Grade 5	\$1,470	\$1,518
	• New! Nymatrix (Nymatrix is for use on the seat only).**	\$1,506	\$1,554
	• Leather	\$1,701	\$1,749

STANDARD SPECIFICATIONS	Backrest	Midnight Black	Light Grey
		• Dual curve mesh backrest (19" w x 25"h)	•
	• 5" Patented back height adjustment system	•	•
STANDARD SPECIFICATIONS	Seat	20" w x 19" d	
		• Dual density molded polyurethane foam	•
	• Eight ply hardwood seat structure	•	•
	• Tailored upholstery on seat pan*	•	•
STANDARD SPECIFICATIONS	Multi Tilt Mechanism	• Infinite lock free float	•
		• Back angle adjustment	•
	• Adjustable spring tension	•	•
	• Infinite forward tilt lock out	•	•
	• 2 1/2" Depth adjustable seat slider	•	•
STANDARD SPECIFICATIONS	Pneumatic Lift (seat height)	• 125 mmLT pneumatic lift (16" - 20 1/2")	•
		•	•
STANDARD SPECIFICATIONS	Base	• 26" Glass reinforced nylon mid profile base	•
		• 5 Dual wheel nylon casters 2	•
STANDARD SPECIFICATIONS	Measurements	56 lbs/11.7 cu.ft	
		• Boxed weight/size	

OPTIONS	Seat	Upcharge	Midnight Black	Light Grey		
			• Energy Absorbant Memory Foam	EA	\$92	•
	• Triple Density Foam (adds 3/4" to seat width & depth)	TDF	\$76	•	•	
	• Non-tailored seat pan	NTS	N/C	•	•	
OPTIONS	Base/Glides/Casters	• 26" Polished aluminum mid-profile base	PMB	\$198	•	•
		• Silver accent casters	CAC	\$113	•	•
	• Dual wheel urethane casters 2		\$54	UC2	GUC2	
OPTIONS	Lifts (seat height)	• 70 mm pneumatic lift (15 1/2" - 18 3/4")	N/C	70MM	G70MM	
		• 80 mm pneumatic lift (16 3/4" - 19 3/4")	N/C	80MM	G80MM	
	• 100 mm pneumatic lift (16 3/4" - 20 3/4")	N/C	100MM	G100MM		
	• 125 mm pneumatic lift (17 3/4" - 21 3/4")	N/C	125MM	G125MM		
	• 140 mm pneumatic lift (18" - 23 1/4")	N/C	140MM	G140MM		
	• 100 mm chrome pneumatic lift (16 3/4" - 20 3/4")	100MMCH	\$40	•	•	
	• 125 mm chrome pneumatic lift (17 3/4" - 21 3/4")	125MMCH	\$40	•	•	
	• 140 mm chrome pneumatic lift (18" - 23 1/4")	140MMCH	\$40	•	•	
OPTIONS	Additional Options (upholstered in Nytek)	• tCentric Lumbar support (12" w x 6" h)*	\$135	TLS	TLSG	
		• tCentric Air Lumbar 1 (hand pump)*	\$277	TLSAL	TLSALG	
	• tCentric Air Lumbar 2 (built-in)*	\$277	TALSC	TALSCG		
	• Midnight Black Tailored adjustable headrest*	\$466	AHR	N/A		
	• Light Grey Tailored adjustable headrest*	\$506	N/A	AHRG		

Note: Mixing of Midnight Black and Light Grey components is not an option.

**Specifying Nymatrix on a seat with a different backrest upholstery is considered Combination Upholstery. To calculate the price of the chair, add the price for a full chair in the grade of the backrest material and a full chair in Nymatrix and divide by 2.

* Standard on fabric upholstery. Only available on vinyl upholstery by request with a \$23 upcharge.

* Black framed chairs use the fabric Nytek in black. Grey framed chairs use Nytek in light grey. Vinyl upholstery is not permitted.



tCentric Hybrid™

Foam and Fabric Seat

Synchro Tilt Series

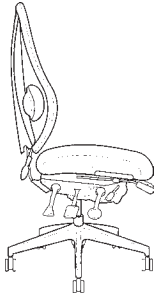
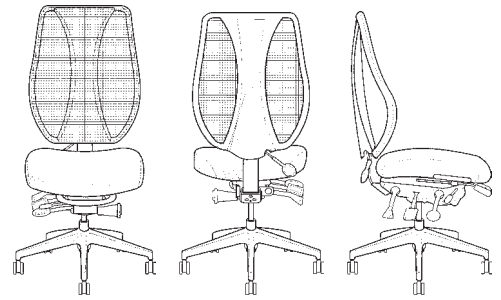

Shown with optional tCentric Lumbar Support

RECOMMENDED ARMS



tCentric Armrest
Height & Lateral Adjustable
Midnight Black TCL \$509
Height & Swivel Adjustable
Midnight Black TC360 \$509
Height, Lateral & Swivel Adjustable
Midnight Black TCL360 \$549

For specifications and illustrations of the tCentric armrests, see pages 69-71.

SEAT SIZE OPTIONS

- Extra Small XSS** \$92
(17 ½" w x 15 ½" d)
- Small SS** N/C
(18 ½" w x 17" d)
- Plus Size PS** \$92
(22" w x 19" d)
- Extra Long XLS** \$92
(20" w x 21" d)
- Extra Deep XPS** \$92
(22" w x 21" d)

For graded in upholstery choices see page 78.

LIST PRICE	List Price	Midnight Black
	<ul style="list-style-type: none"> • Grade 1/COM (yd) • Grade 2 • Grade 3 • Grade 4 • Grade 5 • New! Nymatrix (Nymatrix is for use on the seat only).** • Leather 	t-ST \$1,336 (1) \$1,348 \$1,360 \$1,372 \$1,384 \$1,420 \$1,615

STANDARD SPECIFICATIONS	Backrest	Midnight Black
	<ul style="list-style-type: none"> • Dual curve mesh backrest (19" w x 25"h) • 5" Patented back height adjustment system 	•
Seat		•
<ul style="list-style-type: none"> • Dual density molded polyurethane foam • Eight ply hardwood seat structure • Tailored upholstery on seat pan* 	20"w x 19"d	
Synchro Tilt Mechanism		•
<ul style="list-style-type: none"> • Seat tilt lock out • Free float • Synchro 2:1 ratio • Adjustable spring tension • 2" Depth adjustable seat slider 	•	
Pneumatic Lift (seat height)		•
<ul style="list-style-type: none"> • 125 mmLT pneumatic lift (16" - 20 ½") 		
Base		•
<ul style="list-style-type: none"> • 26" Glass reinforced nylon mid profile base • 5 Dual wheel nylon casters 2 	•	
Measurements		56 lbs/11.7 cu.ft
<ul style="list-style-type: none"> • Boxed weight/size 		

OPTIONS	Seat	Upcharge	Midnight Black
	<ul style="list-style-type: none"> • Energy Absorbant Memory Foam • Triple Density Foam (adds ¼" to seat width & depth) • Non-tailored seat pan 	EA TDF NTS	\$92 \$76 N/C
Base / Glides / Casters			
<ul style="list-style-type: none"> • 26" Polished aluminum mid-profile base • Silver accent casters • Dual wheel urethane casters 2 	PMB CAC	\$198 \$113 \$54	• • UC2
Lifts (seat height)			
<ul style="list-style-type: none"> • 70 mm pneumatic lift (15 ½" - 18 ¼") • 80 mm pneumatic lift (16 ¼" - 19 ¼") • 100 mm pneumatic lift (16 ¾" - 20 ¾") • 125 mm pneumatic lift (17 ¼" - 21 ¾") • 140 mm pneumatic lift (18" - 23 ¼") • 100 mm chrome pneumatic lift (16 ¾" - 20 ¾") • 125 mm chrome pneumatic lift (17 ¼" - 21 ¾") • 140 mm chrome pneumatic lift (18" - 23 ¼") 		N/C N/C N/C N/C N/C 100MMCH 125MMCH 140MMCH \$40 \$40 \$40	70MM 80MM 100MM 125MM 140MM • • •
Additional Options (upholstered in Nytek)			
<ul style="list-style-type: none"> • tCentric Lumbar support (12"w x 6"h)* • tCentric Air Lumbar 1 (hand pump)* • tCentric Air Lumbar 2 (built-in)* • Midnight Black Tailored adjustable headrest* 		\$135 \$277 \$277 \$466	TLS TLSAL TALSC AHR

**Specifying Nymatrix on a seat with a different backrest upholstery is considered Combination Upholstery. To calculate the price of the chair, add the price for a full chair in the grade of the backrest material and a full chair in Nymatrix and divide by 2.

* Standard on fabric upholstery. Only available on vinyl upholstery by request with a \$23 upcharge.

* Black framed chairs use the fabric Nytek in black.

tCentric Hybrid™

Foam and Fabric Seat

Boardroom Series

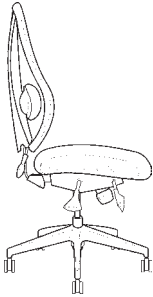
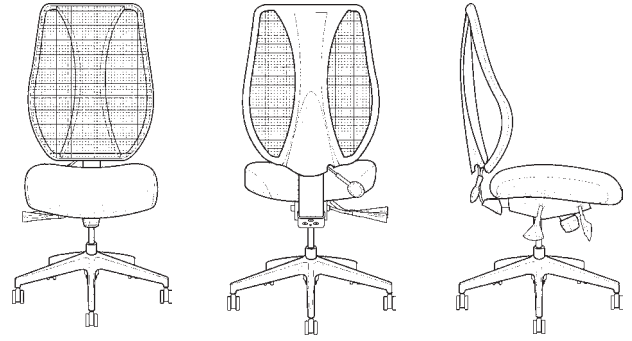

Shown with optional tCentric Lumbar Support

RECOMMENDED ARMS



The All Mesh tCentric Hybrid can only use the TC Armrests.

tCentric Armrest	
Height & Lateral Adjustable	
Midnight Black TCL \$509	Light Grey TCLG \$524
Height & Swivel Adjustable	
Midnight Black TC360 \$509	Light Grey TC360G \$526
Height, Lateral & Swivel Adjustable	
Midnight Black TCL360 \$549	Light Grey TCL360G \$565

For specifications and illustrations of the tCentric armrests, see pages 69-71.

SEAT SIZE OPTIONS

- Extra Small XSS** \$92 (17 ½" w x 15 ½" d)
- Small SS** N/C (18 ½" w x 17" d)
- Plus Size PS** \$92 (22" w x 19" d)
- Extra Long XLS** \$92 (20" w x 21" d)
- Extra Deep XPS** \$92 (22" w x 21" d)

For graded in upholstery choices see page 78.

LIST PRICE	List Price	Midnight Black	Light Grey
		t-BR	t-BRG
	• Grade 1/COM (yd)	\$1,143 (1)	\$1,198 (1)
	• Grade 2	\$1,155	\$1,210
	• Grade 3	\$1,167	\$1,222
	• Grade 4	\$1,179	\$1,234
	• Grade 5	\$1,191	\$1,246
	• New! Nymatrix (Nymatrix is for use on the seat only)**	\$1,227	\$1,282
	• Leather	\$1,422	\$1,477

STANDARD SPECIFICATIONS	Backrest	Midnight Black	Light Grey
		• Dual curve mesh backrest (19" w x 25"h)	•
	• 5" Patented back height adjustment system	•	•
	Seat		
	• Dual density molded polyurethane foam	•	•
	• Eight ply hardwood seat structure	•	•
	• Tailored upholstery on seat pan*	20"w x 19"d	
	Boardroom Mechanism		
	• Single lock free float	•	•
	• Seat height	•	•
	• Adjustable spring tension	•	•
	Pneumatic Lift (seat height)		
	• 125 mm pneumatic lift (16 ¼" - 20 ¾")	•	•
	Base		
	• 26" Glass reinforced nylon mid profile base	•	•
	• 5 Dual wheel nylon casters 2	•	•
	Measurements		
	• Boxed weight/size	56 lbs/11.7 cu.ft	

OPTIONS	Seat	Upcharge	Midnight Black	Light Grey	
			• Energy Absorbant Memory Foam	EA	\$92
	• Triple Density Foam (adds ¼" to seat width & depth)	TDF	\$76	•	•
	• Non-tailored seat pan	NTS	N/C	•	•
	Base / Glides / Casters				
	• 26" Polished aluminum mid-profile base	PMB	\$198	•	•
	• Silver accent casters	CAC	\$113	•	•
	• Dual wheel urethane caster 2		\$54	UC2	GUC2
	Lifts (seat height)				
	• 140 mm pneumatic lift (17" - 22 ¼")		N/C	140MM	G140MM
	• 140 mm chrome pneumatic lift (17" - 22 ¼")	140MMCH	\$40	•	•
	Additional Options (upholstered in Nytek)				
	• tCentric Lumbar support (12"w x 6"h)*		\$135	TLS	TLSG
	• tCentric Air Lumbar 1 (hand pump)*		\$277	TLSAL	TLSALG
	• tCentric Air Lumbar 2 (built-in)*		\$277	TALSC	TALSCG
	• Midnight Black Tailored adjustable headrest*		\$466	AHR	N/A
	• Light Grey Tailored adjustable headrest*		\$506	N/A	AHRG

Note: Mixing of Midnight Black and Light Grey components is not an option.

**Specifying Nymatrix on a seat with a different backrest upholstery is considered Combination Upholstery. To calculate the price of the chair, add the price for a full chair in the grade of the backrest material and a full chair in Nymatrix and divide by 2.

* Standard on fabric upholstery. Only available on vinyl upholstery by request with a \$23 upcharge.

* Black framed chairs use the fabric Nytek in black. Grey framed chairs use Nytek in light grey. Vinyl upholstery is not permitted.



tCentric Hybrid™

Foam and Fabric Seat

Counter Height Series

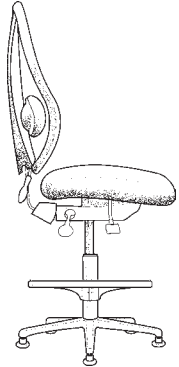
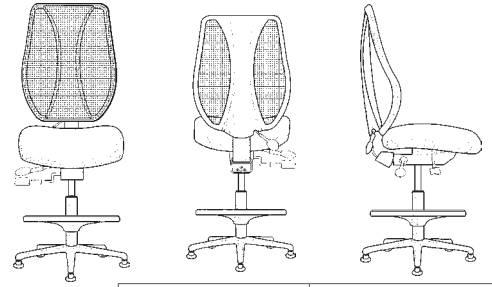

Shown with optional tCentric Lumbar Support

RECOMMENDED ARMS



tCentric Armrest	
Height & Lateral Adjustable	
Midnight Black TCL \$509	Light Grey TCLG \$524
Height & Swivel Adjustable	
Midnight Black TC360 \$509	Light Grey TC360G \$526
Height, Lateral & Swivel Adjustable	
Midnight Black TCL360 \$549	Light Grey TCL360G \$565

For specifications and illustrations of the tCentric armrests, see pages 69-71.

SEAT SIZE OPTIONS

- Extra Small XSS** \$92
(17 ½" w x 15 ½" d)
- Small SS** N/C
(18 ½" w x 17" d)
- Plus Size PS** \$92
(22" w x 19" d)
- Extra Long XLS** \$92
(20" w x 21" d)
- Extra Deep XPS** \$92
(22" w x 21" d)

For graded in upholstery choices see page 78.

LIST PRICE	List Price	Midnight Black	Light Grey
		t-CH	t-CHG
	• Grade 1/COM (yd)	\$1,443 (1)	\$1,494 (1)
	• Grade 2	\$1,455	\$1,506
	• Grade 3	\$1,467	\$1,518
	• Grade 4	\$1,479	\$1,530
	• Grade 5	\$1,491	\$1,542
	• New! Nymatrix (Nymatrix is for use on the seat only).**	\$1,527	\$1,578
	• Leather	\$1,722	\$1,773

STANDARD SPECIFICATIONS	Backrest	Midnight Black	Light Grey
		• Dual curve mesh backrest (19" w x 25"h)	•
	• 5" Patented back height adjustment system	•	•
Seat			
	• Dual density molded polyurethane foam	•	•
	• Eight ply hardwood seat structure	•	•
	• Tailored upholstery on seat pan*	20"w x 19"d	20"w x 19"d
Counter Height Mechanism			
	• Independent back angle adjustment	•	•
	• Fixed seat	•	•
	• Seat height	•	•
Pneumatic Lift			
	• 200 mm pneumatic lift (23" - 29 ½")	•	•
Base			
	• 26" Glass reinforced nylon mid profile base	•	•
	• 20" diameter aluminum, height adjustable footing; 1 ¾" foot platform	•	•
	• 2 ¼" Glides	•	•
Measurements			
	• Boxed weight/size	56 lbs/6.7 cu.ft	

OPTIONS	Seat	Upcharge	Midnight Black	Light Grey	
			• Energy Absorbant Memory Foam	EA	\$92
	• Triple Density Foam (adds ¼" to seat width & depth)	TDF	\$76	•	•
	• Non-tailored seat pan	NTS	N/C	•	•
Base/Glides/Casters					
	• Lock-on urethane casters	LON	\$188	•	•
	• Lock-off urethane casters	LOF	\$89	•	•
	• Dual wheel nylon casters 2		N/C	NC2	GNC2
	• Dual wheel urethane casters 2		\$54	UC2	GUC2
	• Single wheel nylon casters	SW	\$74	•	•
	• Single wheel urethane casters	SWU	\$89	•	•
Lifts (seat height)					
	• 157 mm pneumatic lift (18 ¼" - 23 ¾")		N/C	157MM	G157MM
	• 267 mm pneumatic lift (24 ¼" - 34 ¼")		\$8	267MM	G267MM
Mechanisms					
	• Modified Multi Tilt Mechanism (Seat slider, height and back angle adjustment only)	MT	\$171	•	•
	• Dedicated Task 2 Mechanism	DT2	N/C	•	•
Additional Options (upholstered in Nytek)					
	• tCentric Lumbar support (12"w x 6"h)*		\$135	TLS	TLSG
	• tCentric Air Lumbar 1 (hand pump)*		\$277	TLSAL	TLSALG
	• tCentric Air Lumbar 2 (built-in)*		\$277	TALSC	TALSCG
	• Midnight Black Tailored adjustable headrest*		\$466	AHR	N/A
	• Light Grey Tailored adjustable headrest*		\$506	N/A	AHRG

**Specifying Nymatrix on a seat with a different backrest upholstery is considered Combination Upholstery. To calculate the price of the chair, add the price for a full chair in the grade of the backrest material and a full chair in Nymatrix and divide by 2.

* Standard on fabric upholstery. Only available on vinyl upholstery by request with a \$23 upcharge.

* Black framed chairs use the fabric Nytek in black. Grey framed chairs use Nytek in light grey. Vinyl upholstery is not permitted.



tCentric Hybrid™

Guest Chair

The tCentric Hybrid Guest Chair has the unmistakable backrest design and breathable comfort of the tCentric Hybrid high performance task chair. Incorporating the latest high-tech elastomeric mesh, the tCentric Hybrid's backrest is tensioned for optimal support.

The perfect companion for your tCentric Hybrid office chair.



tCentric Hybrid™

Guest Chair

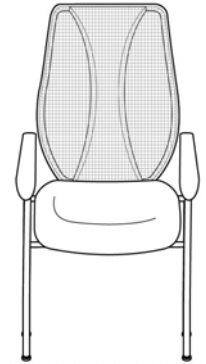

LIST PRICE	List Price	t-GUESTMB (Midnight Black)
	• Grade 1/COM (yd)	\$1,209
	• Grade 2	\$1,221
	• Grade 3	\$1,233
	• Grade 4	\$1,245
	• Grade 5	\$1,257
	• Nymatrix (Nymatrix is for use on the seat only).**	\$1,293
• Leather	\$1,488	

STANDARD SPECIFICATIONS	Backrest	25"h x 19"w
	<ul style="list-style-type: none"> Elastomeric mesh Height from seat: 25" 	
	Seat	19"w x 22"d
	<ul style="list-style-type: none"> Dual density molded polyurethane foam Tailored upholstery on seat pan Your choice of fabric, vinyl, or leather seat upholstery Seat Height: 18" 	
	Armrest	2"w x 11 ½"d
	<ul style="list-style-type: none"> Armrest clearance: 19 ¼" Armrest height: 8" 	
	Frame	• • • • •
<ul style="list-style-type: none"> Welded steel tubular frame 14 Gauge, ⅜" steel tube frame Kick back legs for stability with durable custom glides Black textured semi-gloss powder coat paint Glass filled nylon arms 		
Measurements	23 ¾"w x 24"d x 41"h	
<ul style="list-style-type: none"> Overall dimensions 		

airCentric™ 2

The new and improved

All the benefits of airflow and the proven ergonomic support of a foam and fabric offering, now with improved comfort and appearance. The airCentric 2 combines a sophisticated aesthetic with modular design, full adjustability and airflow comfort.



airCentric 2 Midnight Black
in Air Knit Royal



airCentric 2 Light Grey
in Air Knit Royal

airCentric™ 2

Synchro Glide Series

(Available in Midnight Black and Light Grey Frame)

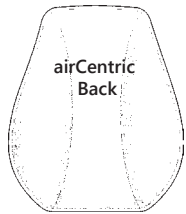

RECOMMENDED ARMS



tCentric Armrest	
Height & Lateral Adjustable	
Midnight Black TCL \$509	Light Grey TCLG \$524
Height & Swivel Adjustable	
Midnight Black TC360 \$509	Light Grey TC360G \$526
Height, Lateral & Swivel Adjustable	
Midnight Black TCL360 \$549	Light Grey TCL360G \$565

Light Grey and Midnight Black options cannot be mixed.
Additional arm options: 103-109.

SEAT OPTIONS

- Extra Small XSS** \$92
(17 ½" w x 15 ½" d)
- Small SS** N/C
(18 ½" w x 17" d)
- Standard LS** N/C
(20" w x 19" d)
- Plus Size PS** \$92
(22" w x 19" d)
- Extra Long XLS** \$92
(20" w x 21" d)

For graded in upholstery choices see page 78.

LIST PRICE	List Price	Midnight Black	Light Grey
		air2-SG	air2-SGG
	• Air Knit	\$1,455	\$1,504
	• Grade 1/COM (yd)	\$1,455 (1 ½)	\$1,504 (1 ½)
	• Grade 2	\$1,470	\$1,519
	• Grade 3	\$1,485	\$1,534
	• Grade 4	\$1,500	\$1,549
	• Grade 5	\$1,515	\$1,564
	• Leather	\$1,850	\$1,899
	• Perforated Leather	\$1,995	\$2,044
	• Perforated Leather/Fabric	\$1,760	\$1,809

STANDARD SPECIFICATIONS	Backrest	Midnight Black	Light Grey
		<ul style="list-style-type: none"> • Front upholstered dual curve backrest • Proprietary airflow molded polyurethane foam and structure • 5" Patented back height adjustment system • back cap with airflow vents 	19" w x 24"h
	Seat	20" w x 19" d	
	<ul style="list-style-type: none"> • Dual density molded polyurethane foam • Eight ply hardwood seat structure seat pan • Tailored upholstery on seat pan* 		
	Synchro Glide Mechanism		
	<ul style="list-style-type: none"> • Seat tilt lock out • Free float • Independent back angle adjustment • Synchro 2:1 ratio • Adjustable spring tension • 2 ½" Depth adjustable seat slider 		
	Pneumatic Lift (seat height)		
	• 125 mmLT pneumatic lift (17" - 21 ½")		
	Base		
	<ul style="list-style-type: none"> • 26" Glass reinforced nylon mid-profile base • 5 Dual wheel nylon casters 2 		
	Measurements	56 lbs/11.7 cu.ft	
	• Boxed weight/size		

OPTIONS	Seat	Upcharge	Midnight Black	Light Grey	
			<ul style="list-style-type: none"> • Energy absorbant memory foam • Triple density foam (adds ¼" to seat width & depth) • Non-tailored seat pan 	EA TDF NTS	\$92 \$76 N/C
	Base/Glides/Casters				
	• 26" Glass Reinforced Nylon Base	26NB	(\$12)	•	•
	• 26" Polished aluminum mid-profile base	PMB	\$198	•	•
	• Silver accent casters	CAC	\$113	•	•
	• Dual wheel urethane casters 2		\$54	UC2	GUC2
	• Single wheel nylon casters	SW	\$74	•	•
	• Single wheel urethane casters	SWU	\$82	•	•
	• 2 ¾" Glides	2G	N/C	•	•
	Lifts (seat height)				
	• 80 mm pneumatic lift (17 ¼" - 20 ¼")		N/C	80MM	G80MM
	• 100 mm pneumatic lift (17 ¾" - 21 ¾")		N/C	100MM	G100MM
	• 140 mm pneumatic lift (19" - 24 ¾")		N/C	140MM	G140MM
	Additional Options				
	• Air lumbar		\$189	AL	ALG
	• Air thoracic		\$222	AT	ATG
	• Midnight Black tailored adjustable headrest*		\$466	AHR	N/A
	• Light Grey tailored adjustable headrest*		\$506	N/A	AHRG

† 70mm and 80mm lifts come with the 26" Glass reinforced nylon mid-profile base as standard.
 * Standard on fabric upholstery. Only available on vinyl upholstery by request with a \$23 upcharge.
 * Black framed chairs use the fabric Nytek in black. Grey framed chairs use Nytek in light grey. Vinyl upholstery is not permitted.



airCentric™ 2

Multi Tilt Series

(Available in Midnight Black and Light Grey Frame)

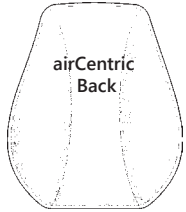

RECOMMENDED ARMS



tCentric Armrest	
Height & Lateral Adjustable	
Midnight Black TCL \$509	Light Grey TCLG \$524
Height & Swivel Adjustable	
Midnight Black TC360 \$509	Light Grey TC360G \$526
Height, Lateral & Swivel Adjustable	
Midnight Black TCL360 \$549	Light Grey TCL360G \$565

Light Grey and Midnight Black options cannot be mixed.
Additional arm options: 103-109.

SEAT OPTIONS

- Extra Small XSS** \$92
(17 ½" w x 15 ½" d)
- Small SS** N/C
(18 ½" w x 17" d)
- Standard LS** N/C
(20" w x 19" d)
- Plus Size PS** \$92
(22" w x 19" d)
- Extra Long XLS** \$92
(20" w x 21" d)

For graded in upholstery choices see page 78.

* Black framed chairs use the fabric Nytek in black. Grey framed chairs use Nytek in light grey. Vinyl upholstery is not permitted.

LIST PRICE	List Price	Midnight Black	Light Grey
		air2-MT	air2-MTG
	• Air Knit	\$1,343	\$1,394
	• Grade 1/COM (yd)	\$1,343 (1 ½)	\$1,394 (1 ½)
	• Grade 2	\$1,358	\$1,409
	• Grade 3	\$1,373	\$1,424
	• Grade 4	\$1,388	\$1,439
	• Grade 5	\$1,403	\$1,454
	• Leather	\$1,738	\$1,789
	• Perforated Leather	\$1,883	\$1,934
	• Perforated Leather/Fabric	\$1,648	\$1,699

STANDARD SPECIFICATIONS	Backrest	Midnight Black	Light Grey
		19" w x 24"h	19" w x 24"h
	• Front upholstered dual curve backrest	•	•
	• Proprietary airflow molded polyurethane foam and structure	•	•
	• 5" Patented back height adjustment system	•	•
	• back cap with airflow vents	•	•
	Seat	20" w x 19" d	
	• Dual density molded polyurethane foam	•	•
	• Eight ply hardwood seat structure seat pan	•	•
	• Tailored upholstery on seat pan*	•	•
	Multi Tilt Mechanism		
	• Infinite lock free float	•	•
	• Back angle adjustment	•	•
	• Adjustable spring tension	•	•
	• Infinite forward tilt lock out	•	•
	• 2 ½" Depth adjustable seat slider	•	•
	Pneumatic Lift (seat height)		
	• 125 mmLT pneumatic lift (16" - 20 ½")	•	•
	Base		
	• 26" Glass reinforced nylon mid-profile base	•	•
	• 5 Dual wheel nylon casters 2	•	•
	Measurements	56 lbs/11.7 cu.ft	
	• Boxed weight/size		

OPTIONS	Seat	Upcharge	Midnight Black	Light Grey	
			• Energy absorbant memory foam	EA	\$92
	• Triple density foam (adds ¼" to seat width & depth)	TDF	\$76	•	•
	• Non-tailored seat pan	NTS	N/C	•	•
	Base/Glides/Casters				
	• 26" Glass Reinforced Nylon Base	26NB	(\$12)	•	•
	• 26" Polished aluminum mid-profile base	PMB	\$198	•	•
	• Silver accent casters	CAC	\$113	•	•
	• Dual wheel urethane casters 2		\$54	UC2	GUC2
	• Single wheel nylon casters	SW	\$74	•	•
	• Single wheel urethane casters	SWU	\$82	•	•
	• 2 ¼" Glides	2G	N/C	•	•
	Lifts (seat height)				
	• 80 mm pneumatic lift (16 ¼" - 19 ¼")†		N/C	80MM	G80MM
	• 100 mm pneumatic lift (16 ¾" - 20 ½")		N/C	100MM	G100MM
	• 140 mm pneumatic lift (18" - 23 ¼")		N/C	140MM	G140MM
	Additional Options				
	• Air lumbar		\$189	AL	ALG
	• Air thoracic		\$222	AT	ATG
	• Tailored adjustable headrest *		\$466	AHR	N/A
	• Tailored adjustable headrest *		\$506	N/A	AHRG
	• 24 Hour Multi Tilt Mechanism **	24MT	\$387	•	N/A

† 80mm lifts come with the 26" Glass reinforced nylon mid-profile base as standard.
 * Standard on fabric upholstery. Only available on vinyl upholstery by request with a \$23 upcharge.
 ** Warranted for 24 hour use up to a weight of 300 lbs.



airCentric™ 2

Synchro Tilt Series

(Available in Midnight Black Frame)

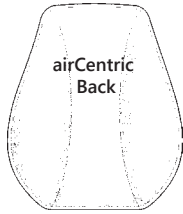

RECOMMENDED ARMS



tCentric Armrest	
Height & Lateral Adjustable	
Midnight Black TCL \$509	Light Grey TCLG \$524
Height & Swivel Adjustable	
Midnight Black TC360 \$509	Light Grey TC360G \$526
Height, Lateral & Swivel Adjustable	
Midnight Black TCL360 \$549	Light Grey TCL360G \$565

Light Grey and Midnight Black options cannot be mixed. Additional arm options: 103-109.

SEAT OPTIONS

- Extra Small XSS** \$92
(17 ½"w x 15 ½"d)
- Small SS** N/C
(18 ½"w x 17"d)
- Standard LS** N/C
(20"w x 19"d)
- Plus Size PS** \$92
(22"w x 19"d)
- Extra Long XLS** \$92
(20"w x 21"d)

For graded in upholstery choices see page 78.

* Black framed chairs use the fabric Nytek in black. Grey framed chairs use Nytek in light grey. Vinyl upholstery is not permitted.

LIST PRICE	List Price	Midnight Black
		air2-ST
	• Air Knit	\$1,257
	• Grade 1/COM (yd)	\$1,257 (1 ½)
	• Grade 2	\$1,272
	• Grade 3	\$1,287
	• Grade 4	\$1,302
	• Grade 5	\$1,317
	• Leather	\$1,652
	• Perforated Leather	\$1,797
	• Perforated Leather/Fabric	\$1,652

STANDARD SPECIFICATIONS	Backrest	Midnight Black
		<ul style="list-style-type: none"> • Front upholstered dual curve backrest • Proprietary airflow molded polyurethane foam and structure • 5" Patented back height adjustment system • back cap with airflow vents
Seat	<ul style="list-style-type: none"> • Dual density molded polyurethane foam • Eight ply hardwood seat structure seat pan • Tailored upholstery on seat pan* 	• 20"w x 19"d •
	Multi Tilt Mechanism	<ul style="list-style-type: none"> • Seat tilt lock out • Free float • Synchro 2:1 ratio • Adjustable spring tension • 2" Depth adjustable seat slider
Pneumatic Lift (seat height)	<ul style="list-style-type: none"> • 125 mmLT pneumatic lift (16" - 20 ½") 	•
	Base	<ul style="list-style-type: none"> • 26" Glass reinforced nylon mid-profile base • 5 Dual wheel nylon casters 2
Measurements	<ul style="list-style-type: none"> • Boxed weight/size 	56 lbs/11.7 cu.ft

OPTIONS	Seat	Upcharge	Midnight Black	
			<ul style="list-style-type: none"> • Energy absorbant memory foam • Triple density foam (adds ¼" to seat width & depth) • Non-tailored seat pan 	EA TDF NTS
Base/Glides/Casters	<ul style="list-style-type: none"> • 26" Glass Reinforced Nylon Base • 26" Polished aluminum mid-profile base • Silver accent casters • Dual wheel urethane casters 2 • Single wheel nylon casters • Single wheel urethane casters • 2 ¼" Glides 	26NB PMB CAC SW SWU 2G	(\$12) \$198 \$113 \$54 \$74 \$82 N/C	• • • UC2 • • •
	Lifts (seat height)	<ul style="list-style-type: none"> • 80 mm pneumatic lift (16 ¾" - 19 ¾")† • 100 mm pneumatic lift (16 ¾" - 20 ½") • 140 mm pneumatic lift (18" - 23 ¾") 		N/C N/C N/C
Additional Options	<ul style="list-style-type: none"> • Air lumbar • Air thoracic • Tailored adjustable headrest * • Tailored adjustable headrest * • 24 Hour Multi Tilt Mechanism ** 		\$189 \$222 \$466 \$506 \$387	AL AT AHR N/A •

† 80mm lifts come with the 26" Glass reinforced nylon mid-profile base as standard.
 * Standard on fabric upholstery. Only available on vinyl upholstery by request with a \$23 upcharge.
 ** Warranted for 24 hour use up to a weight of 300 lbs.

airCentric™ 2

Boardroom Series

(Available in Midnight Black and Light Grey Frame)

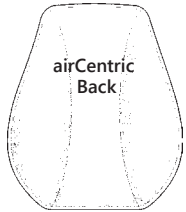

RECOMMENDED ARMS



tCentric Armrest	
Height & Lateral Adjustable	
Midnight Black TCL \$509	Light Grey TCLG \$524
Height & Swivel Adjustable	
Midnight Black TC360 \$509	Light Grey TC360G \$526
Height, Lateral & Swivel Adjustable	
Midnight Black TCL360 \$549	Light Grey TCL360G \$565

Light Grey and Midnight Black options cannot be mixed.
Additional arm options: 103-109.

SEAT OPTIONS

Extra Small XSS \$92
(17 ½" w x 15 ½" d)

Small SS N/C
(18 ½" w x 17" d)

Standard LS N/C
(20" w x 19" d)

Plus Size PS \$92
(22" w x 19" d)

Extra Long XLS \$92
(20" w x 21" d)

For graded in upholstery choices see page 78.

LIST PRICE	List Price	Midnight Black	Light Grey
		air2-BR	air2-BRG
	• Air Knit	\$1,081	\$1,122
	• Grade 1/COM (yd)	\$1,081(1 ½)	\$1,122 (1 ½)
	• Grade 2	\$1,096	\$1,137
	• Grade 3	\$1,111	\$1,152
	• Grade 4	\$1,126	\$1,167
	• Grade 5	\$1,141	\$1,182
	• Leather	\$1,476	\$1,517
	• Perforated Leather	\$1,621	\$1,662
	• Perforated Leather/Fabric	\$1,386	\$1,427

STANDARD SPECIFICATIONS	Backrest	Midnight Black	Light Grey
		<ul style="list-style-type: none"> Front upholstered dual curve backrest Proprietary airflow molded polyurethane foam and structure 5" Patented back height adjustment system back cap with airflow vents 	19" w x 24"h
	Seat		
	<ul style="list-style-type: none"> Dual density molded polyurethane foam Eight ply hardwood seat structure seat pan Tailored upholstery on seat pan* 	20" w x 19" d	
	Boardroom Mechanism		
	<ul style="list-style-type: none"> Single lock free float Seat height Adjustable spring tension 		
	Pneumatic Lift (seat height)		
	<ul style="list-style-type: none"> 125 mm pneumatic lift (16 ¼" - 20 ¾") 		
	Base		
	<ul style="list-style-type: none"> 26" Glass reinforced nylon mid-profile base 5 Dual wheel nylon casters 2 		
	Measurements		
	<ul style="list-style-type: none"> Boxed weight/size 	56 lbs/11.7 cu.ft	

OPTIONS	Seat	Upcharge	Midnight Black	Light Grey
		<ul style="list-style-type: none"> Triple density foam (adds ¼" to seat width & depth) Non-tailored seat pan 	TDF NTS	\$76 N/C
	Base / Glides / Casters			
	<ul style="list-style-type: none"> 26" Glass Reinforced Nylon Base 26" Polished aluminum mid-profile base Silver accent casters Dual wheel urethane casters 2 	26NB PMB CAC	(\$12) \$198 \$114	• • • •
	Lifts (seat height)			
	<ul style="list-style-type: none"> 80 mm pneumatic lift (15 ¼"-18 ¼") 100 mm pneumatic lift (15 ¾"-19 ¾") 140 mm pneumatic lift (17"-22 ¼") 		N/C N/C N/C	80MM 100MM 140MM
				G80MM G100MM G140MM

* Standard on fabric upholstery. Only available on vinyl upholstery by request with a \$23 upcharge.

* Black framed chairs use the fabric Nytek in black. Grey framed chairs use Nytek in light grey. Vinyl upholstery is not permitted.

airCentric™ 2

Counter Height Series

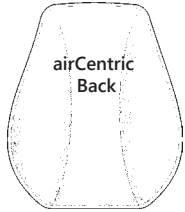

RECOMMENDED ARMS



tCentric Armrest	
Height & Lateral Adjustable	
Midnight Black TCL \$509	Light Grey TCLG \$524
Height & Swivel Adjustable	
Midnight Black TC360 \$509	Light Grey TC360G \$524
Height, Lateral & Swivel Adjustable	
Midnight Black TCL360 \$549	Light Grey TCL360G \$565

Light Grey and Midnight Black options cannot be mixed.
Additional arm options: 103-109.

SEAT OPTIONS

- Extra Small XSS** \$92
(17 ½" w x 15 ½" d)
- Small SS** N/C
(18 ½" w x 17" d)
- Standard LS** N/C
(20" w x 19" d)
- Plus Size PS** \$92
(22" w x 19" d)
- Extra Long XLS** \$92
(20" w x 21" d)

For graded in upholstery choices see page 78.

LIST PRICE	List Price	Midnight Black	Light Grey
		air2-CH	air2-CHG
	• Air Knit	\$1,366	\$1,417
	• Grade 1/COM (yd)	\$1,366 (1 ½)	\$1,417 (1 ½)
	• Grade 2	\$1,381	\$1,432
	• Grade 3	\$1,396	\$1,447
	• Grade 4	\$1,411	\$1,462
	• Grade 5	\$1,426	\$1,477
	• Leather	\$1,761	\$1,812
	• Perforated Leather	\$1,906	\$1,957
	• Perforated Leather/Fabric	\$1,671	\$1,722

STANDARD SPECIFICATIONS	Backrest	Midnight Black	Light Grey
		<ul style="list-style-type: none"> • Front upholstered dual curve backrest • Proprietary airflow molded polyurethane foam and structure • 5" Patented back height adjustment system • back cap with airflow vents 	19" w x 24"h
Seat			
	<ul style="list-style-type: none"> • Dual density molded polyurethane foam • Eight ply hardwood seat structure seat pan • Tailored upholstery on seat pan* 	20"w x 19"d	
Counter Height Mechanism			
	<ul style="list-style-type: none"> • Independent back angle adjustment • Fixed seat • Seat height 		
Pneumatic Lift (seat height)			
	<ul style="list-style-type: none"> • 200 mm pneumatic lift (23" - 29 ½") 		
Base			
	<ul style="list-style-type: none"> • 26" Glass reinforced nylon mid-profile base • 20" diameter aluminum, height adjustable footing; 1.75" foot platform • 2 ¼" Glides 		
Measurements			
	<ul style="list-style-type: none"> • Boxed weight/size 	56 lbs/11.7 cu.ft	

OPTIONS	Seat	Upcharge	Midnight Black	Light Grey
		• Triple Density Foam (adds ¼" to seat width & depth)	TDF \$76	•
	• Non-tailored seat pan	NTS N/C	•	•
Base/Glides/Casters				
	<ul style="list-style-type: none"> • Lock-on urethane casters • Lock-off urethane casters • Dual wheel nylon casters • Dual wheel urethane casters 2 • Single wheel nylon casters • Single wheel urethane casters 	LON \$188 LOF \$89 N/C \$54 SW \$74 SWU \$82	• • • • • •	• • GNC2 GUC2 • •
Lifts (seat height)				
	<ul style="list-style-type: none"> • 157 mm pneumatic lift (18 ¼" - 23 ¾") • 267 mm pneumatic lift (24 ¼" - 34 ¼") 	N/C \$8	157MM 267MM	G157MM G267MM
Additional Options				
	<ul style="list-style-type: none"> • Modified Multi Tilt Mechanism (Seat slider, height and back angle adjustment only) • Dedicated Task 2 Mechanism 	MT \$171 DT2 N/C	• •	• •

* Standard on fabric upholstery. Only available on vinyl upholstery by request with a \$23 upcharge.
* Black framed chairs use the fabric Nytek in black. Grey framed chairs use Nytek in light grey. Vinyl upholstery is not permitted.

airCentric™

Stacker

The airCentric™ stacker chair provides a modern aesthetic with a unique airflow backrest complementing the design of the airCentric 2 ergonomic task chair.



airCentric™

Stacker

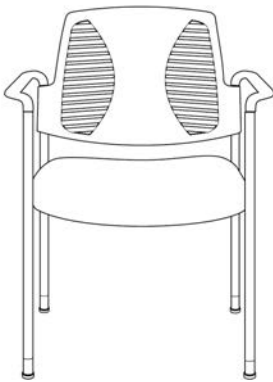
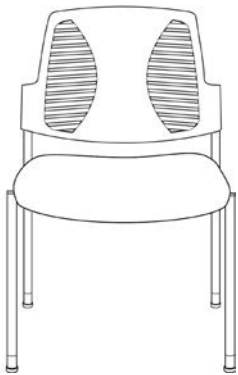

LIST PRICE		Midnight Black	Midnight Black	Light Grey	Light Grey
	List Price	air2-STACKER (without arms)	air2-STACKER-A (with arms)	air2G-STACKER (without arms)	air2G-STACKER-A (with arms)
	• Grade 1/COM (yd)	\$533	\$597	\$583	\$647
	• Grade 2	\$548	\$612	\$598	\$662
	• Grade 3	\$563	\$627	\$613	\$677
	• Grade 4	\$578	\$642	\$628	\$692
	• Grade 5	\$593	\$657	\$643	\$707
	• Leather	\$928	\$992	\$978	\$1,042

STANDARD SPECIFICATIONS	Backrest		
	• Dual curve backrest		•
• Back height from seat: 16 ½ inches		18 ¼" w x 14 ½" h	18 ¾" w x 14 ½" h
Seat			
• Dual curve waterfall seat		•	•
• Tailored upholstery on seat pan		18 ½" w x 19 ½" d	18 ½" w x 19 ½" d
• Seat Height: 17"		•	•
Armrest			
• Distance between arms: 20 ¾"		N/A	2" w x 11 ½" d
• Armrest height from seat: 8 ½"			
Frame			
• Welded steel tubular frame		•	•
• 14 Gauge, ⅞" steel tube frame		•	•
• Kick back legs for stability with durable custom glides		•	•
• Black textured semi-gloss powder coat paint		•	•
• Glass filled nylon arms		N/A	•
Measurements			
• Overall dimensions		20" w x 19" d x 31" h	23 ½" w x 19" d x 31" h
• Boxed weight/size		21 lbs/13 cu.ft	24 lbs/13 cu.ft
• Shipped 2 per carton		42 lbs	48 lbs

OPTIONS	Base/Glides/Casters	Upcharge	Stacker with Arms	Stacker without Arms
	• Nylon stacker casters	NSC	\$69	•
• Urethane stacker casters	USC	\$104	•	•
Additional Options				
• Cart (23" w x 29 ¾" l x 14 ¾" h) Stackable 6 units high without cart and 10 units high with cart	CART	\$495	•	•
• Ganging clips (set of 2) chair with no arms	GCNA	\$50	N/A	•

geoCentric™

Ultimate adjustability.

The most versatile, functional and adaptable seating system on the market. The geoCentric series provides the ideal seating solution for all office requirements including multi task, multi user, dedicated tasks and general office work.



geoCentric™

Synchro Glide Series

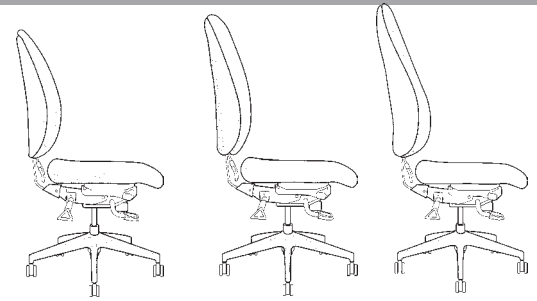

geoCentric Extra Tall-Back

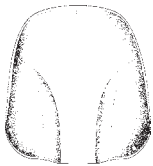
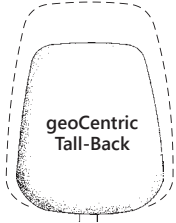

Black Back Cap
PBCMBF

Standard on vinyl and PVC Free (vinyl like) upholstery. Ideal for extra durability and cleanability.

RECOMMENDED ARMS



4" Adjustable T-Arm
4ATAOT \$317



3" Adjustable T-Arm
3ATAOT \$208



4" Adjustable Swivel Arm
SWV \$476

For specifications, illustrations and additional arm options, see pages 69-71.

SEAT SIZE OPTIONS

Extra Small XSS \$92
(17 ½"w x 15 ½"d)

Small SS N/C
(18 ½"w x 17"d)

Plus Size PS \$92
(22"w x 19"d)

Extra Long XLS \$92
(20"w x 21"d)

Extra Deep XPS \$92
(22"w x 21"d)

For graded in upholstery choices see page 78.

LIST PRICE	List Price	geo-MB-SG	geo-TB-SG	geo-XTB-SG
	• Grade 1/COM (yd)		\$1,323 (1 ½)	\$1,407 (2)
• Grade 2		\$1,348	\$1,437	\$1,567
• Grade 3		\$1,373	\$1,467	\$1,602
• Grade 4		\$1,398	\$1,497	\$1,637
• Grade 5		\$1,423	\$1,527	\$1,672
• Leather Match		\$1,668	\$1,782	\$1,942
• Leather		\$1,893	\$2,012	\$2,182
• Black Back Cap Standard with Vinyl, PVC-free (vinyl-like) Upholsteries		(\$17)	N/A	N/A

STANDARD SPECIFICATIONS	Backrest	geo-MB-SG	geo-TB-SG	geo-XTB-SG
	• 5" Patented back height adjustment system		•	•
• Fully upholstered dual curve backrest		17"w x 19"h	17"w x 21"h	19"w x 25"h
Seat				
• Dual density molded polyurethane foam		•	•	•
• Eight ply hardwood seat structure		•	•	•
• Tailored upholstery on seat pan*		20"w x 19"d	20"w x 19"d	20"w x 19"d
Synchro Glide Mechanism				
• Seat tilt lock out		•	•	•
• Free float		•	•	•
• Independent back angle adjustment		•	•	•
• Synchro 2:1 ratio		•	•	•
• Adjustable spring tension		•	•	•
• 2 ½" Depth adjustable seat slider		•	•	•
Pneumatic Lift (seat height)				
• 125 mmLT pneumatic lift (17" - 21 ½")		•	•	•
Base				
• 26" Glass reinforced nylon mid-profile base		•	•	•
• 5 Dual wheel nylon casters 2		•	•	•
Measurements				
• Boxed weight/size		52 lbs/6.7 cu.ft	55 lbs/10 ¾ cu.ft	59 lbs/11.7 cu.ft

OPTIONS	Seat	Upcharge	geo-MB-SG	geo-TB-SG	geo-XTB-SG
	• Energy absorbant memory foam	EA	\$92	•	•
• Triple density foam (adds ¼" to seat width & depth)	TDF	\$76	•	•	•
• Non-tailored seat pan	NTS	N/C	•	•	•
Base/Glides/Casters					
• 26" Polished aluminum mid-profile base	PMB	\$198	•	•	•
• Silver accent casters	CAC	\$113	•	•	•
• Dual wheel urethane casters	UC	\$54	•	•	•
• Single wheel nylon casters	SW	\$74	•	•	•
• Single wheel urethane casters	SWU	\$82	•	•	•
• 2 ¼" Glides	2G	N/C	•	•	•
Lifts (seat height)					
• 70 mm pneumatic lift (16 ½" - 19 ¼")	70MM	N/C	•	•	•
• 80 mm pneumatic lift (17 ¼" - 20 ¼")	80MM	N/C	•	•	•
• 100 mm pneumatic lift (17 ¾" - 21 ¾")	100MM	N/C	•	•	•
• 140 mm pneumatic lift (19" - 24 ¼")	140MM	N/C	•	•	•
Additional Options					
• Air lumbar	AL	\$189	•	•	•
• Air thoracic	AT	\$222	•	•	•
• Air thoracic and air lumbar ▲	ATL	\$370	N/A	•	•
• Thoracic back support	THB	\$92	•	•	•
• Adjustable headrest*	AHR	\$466	•	•	•
• Back cap - fabric upholstery	PBCMBF	N/C	•	N/A	N/A
• Neck support	NNS	\$92	N/A	N/A	N/A

▲ Not available with the pull through design on the geoCentric Mid Back.

* Standard on fabric upholstery. Only available on vinyl upholstery by request with a \$23 upcharge.

* Uses the fabric Nytekin in black.Vinyl upholstery is not permitted..



geoCentric™

Multi Tilt Series

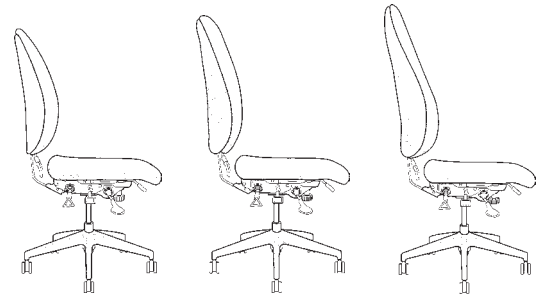

geoCentric Extra Tall-Back

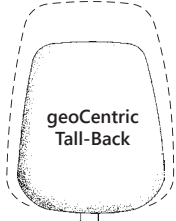

geoCentric Tall-Back

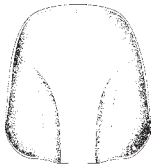

Black Back Cap PBCMBF

Standard on vinyl and PVC Free (vinyl like) upholsteries. Ideal for extra durability and cleanability.

RECOMMENDED ARMS



4" Adjustable T-Arm
4ATAOT \$317



3" Adjustable T-Arm
3ATAOT \$208

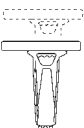

4" Adjustable Swivel Arm
SWV \$476

For specifications, illustrations and additional arm options, see pages 69-71.

SEAT SIZE OPTIONS

Extra Small XSS \$92
(17 1/2"w x 15 1/2"d)

Small SS N/C
(18 1/2"w x 17"d)

Plus Size PS \$92
(22"w x 19"d)

Extra Long XLS \$92
(20"w x 21"d)

Extra Deep XPS \$92
(22"w x 21"d)

For graded in upholstery choices see page 78.

LIST PRICE	List Price	geo-MB-MT	geo-TB-MT	geo-XTB-MT
	• Grade 1/COM (yd)	\$1,264 (1 1/2)	\$1,295 (2)	\$1,422 (2)
	• Grade 2	\$1,289	\$1,325	\$1,457
	• Grade 3	\$1,314	\$1,355	\$1,492
	• Grade 4	\$1,339	\$1,385	\$1,527
	• Grade 5	\$1,364	\$1,415	\$1,562
	• Leather Match	\$1,609	\$1,670	\$1,832
	• Leather	\$1,834	\$1,900	\$2,072
• Black Back Cap Standard with Vinyl, PVC-free (vinyl-like) Upholsteries	(\$17)	N/A	N/A	

STANDARD SPECIFICATIONS	Backrest	geo-MB-MT	geo-TB-MT	geo-XTB-MT
	• 5" Patented back height adjustment system	•	•	•
	• Fully upholstered dual curve backrest	17"w x 19"h	17"w x 21"h	19"w x 25"h
	Seat			
	• Dual density molded polyurethane foam	•	•	•
	• Eight ply hardwood seat structure	•	•	•
	• Tailored upholstery on seat pan*	20"w x 19"d	20"w x 19"d	20"w x 19"d
	Multi Tilt Mechanism			
	• Infinite lock free float	•	•	•
	• Back angle adjustment	•	•	•
• Adjustable spring tension	•	•	•	
• Infinite forward tilt lock out	•	•	•	
• 2 1/2" Depth adjustable seat slider	•	•	•	
Pneumatic Lift (seat height)				
• 125 mmLT pneumatic lift (16" - 20 1/2")	•	•	•	
Base				
• 26" Glass reinforced nylon mid-profile base	•	•	•	
• 5 Dual wheel nylon casters 2	•	•	•	
Measurements				
• Boxed weight/size	49 lbs/6.7 cu.ft	52 lbs/10 3/4 cu.ft	56 lbs/11.7 cu.ft	

OPTIONS	Seat	Upcharge	geo-MB-MT	geo-TB-MT	geo-XTB-MT	
	• Energy absorbant memory foam	EA	\$92	•	•	•
	• Triple density foam (adds 1/4" to seat width & depth)	TDF	\$76	•	•	•
	• Non-tailored seat pan	NTS	N/C	•	•	•
	Base / Glides / Casters					
	• 26" Polished aluminum mid-profile base	PMB	\$198	•	•	•
	• Silver accent casters	CAC	\$113	•	•	•
	• Dual wheel urethane casters	UC	\$54	•	•	•
	• Single wheel nylon casters	SW	\$74	•	•	•
	• Single wheel urethane casters	SWU	\$82	•	•	•
• 2 1/4" Glides	2G	N/C	•	•	•	
Lifts (seat height)						
• 70 mm pneumatic lift (15 1/2" - 18 3/4")	70MM	N/C	•	•	•	
• 80 mm pneumatic lift (16 3/4" - 19 3/4")	80MM	N/C	•	•	•	
• 100 mm pneumatic lift (16 3/4" - 20 3/4")	100MM	N/C	•	•	•	
• 140 mm pneumatic lift (18" - 23 1/4")	140MM	N/C	•	•	•	
Additional Options						
• Air lumbar	AL	\$189	•	•	•	
• Air thoracic	AT	\$222	•	•	•	
• Air thoracic and air lumbar ▲	ATL	\$370	N/A	•	•	
• Adjustable headrest *	AHR	\$466	•	•	•	
• Thoracic back support	THB	\$92	•	•	•	
• Back cap - fabric upholstery	PBCMBF	N/C	•	N/A	N/A	
• Neck support	NNS	\$92	N/A	N/A	N/A	
• 24 Hour Multi Tilt Mechanism **	24MT	\$387	•	•	•	

▲ Not available with the pull through design on the geoCentric Mid Back.

** Warranted for 24 hour use up to a weight of 300 lbs.

* Standard on fabric upholstery. Only available on vinyl upholstery by request with a \$23 upcharge.

* Uses the fabric Nytek in black.Vinyl upholstery is not permitted.



geoCentric™

Counter Height Series



geoCentric Extra Tall-Back

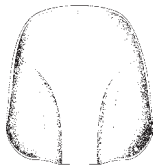
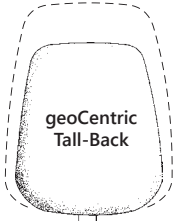

Black Back Cap
PBCMBF

Standard on vinyl and PVC Free (vinyl like) upholsteries. Ideal for extra durability and cleanability.

RECOMMENDED ARMS



4" Adjustable T-Arm
4ATAOT \$317



3" Adjustable T-Arm
3ATAOT \$208

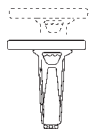

4" Adjustable Swivel Arm
SWV \$476

For specifications, illustrations and additional arm options, see pages 69-71.

SEAT SIZE OPTIONS

Extra Small XSS \$92
(17 ½"w x 15 ½"d)

Small SS N/C
(18 ½"w x 17"d)

Plus Size PS \$92
(22"w x 19"d)

Extra Long XLS \$92
(20"w x 21"d)

Extra Deep XPS \$92
(22"w x 21"d)

For graded in upholstery choices see page 78.

LIST PRICE	List Price	geo-MB-CH	geo-TB-CH	geo-XTB-CH
	• Grade 1/COM (yd)	\$1,286	\$1,317	\$1,443
• Grade 2	\$1,311	\$1,347	\$1,478	\$1,478
• Grade 3	\$1,336	\$1,377	\$1,513	\$1,513
• Grade 4	\$1,361	\$1,407	\$1,548	\$1,548
• Grade 5	\$1,386	\$1,437	\$1,583	\$1,583
• Leather Match	\$1,631	\$1,692	\$1,853	\$1,853
• Leather	\$1,856	\$1,922	\$2,093	\$2,093
• Black Back Cap (Standard with Vinyl, PVC-free (vinyl-like) Upholsteries)	(\$17)	N/A	N/A	N/A

STANDARD SPECIFICATIONS	Backrest	geo-MB-CH	geo-TB-CH	geo-XTB-CH
	• 5" Patented back height adjustment system	•	•	•
• Fully upholstered dual curve backrest	17"w x 19"h	17"w x 21"h	19"w x 25"h	
Seat	• Dual density molded polyurethane foam	•	•	•
• Eight ply hardwood seat structure	•	•	•	
• Tailored upholstery on seat pan*	20"w x 19"d	20"w x 19"d	20"w x 19"d	
Counter Height Mechanism	• Independent back angle adjustment	•	•	•
• Fixed seat	•	•	•	
• Seat height	•	•	•	
Pneumatic Lift (seat height)	• 200 mm pneumatic lift (23" - 29 ½")	•	•	•
Base	• 26" Glass reinforced nylon mid-profile base	•	•	•
• 20" diameter aluminum, height adjustable footring; 1.75" foot platform	•	•	•	
• 2 ¾" Glides	•	•	•	
Measurements	• Boxed weight/size	52 lbs/6.7 cu.ft	55 lbs/10 ¾ cu.ft	59 lbs/11.7 cu.ft

OPTIONS	Seat	Upcharge	geo-MB-CH	geo-TB-CH	geo-XTB-CH	
	• Energy absorbant memory foam	EA	\$92	•	•	•
• Triple density foam (adds ¼" to seat width & depth)	TDF	\$76	•	•	•	
• Non-tailored seat pan	NTS	N/C	•	•	•	
Base / Glides / Casters	• Lock-on urethane casters	LON	\$188	•	•	•
• Lock-off urethane casters	LOF	\$89	•	•	•	
• Dual wheel nylon casters	NC	N/C	•	•	•	
• Dual wheel urethane casters	UC	\$54	•	•	•	
• Single wheel nylon casters	SW	\$74	•	•	•	
• Single wheel urethane casters	SWU	\$82	•	•	•	
Lifts (seat height)	• 157 mm pneumatic lift (18 ¾" - 23 ¾")	157MM	N/C	•	•	•
• 267 mm pneumatic lift (24 ¾" - 34 ¾")	267MM	\$8	•	•	•	
Additional Options	• Air lumbar	AL	\$189	•	•	•
• Air thoracic	AT	\$222	•	•	•	
• Air thoracic and air lumbar ▲	ATL	\$370	N/A	•	•	
• Adjustable headrest *	AHR	\$466	•	•	•	
• Thoracic back support	THB	\$92	•	•	•	
• Back cap - fabric upholstery	PBCMBF	N/C	•	N/A	N/A	
• Dedicated Task Mechanism	DT2	N/C	•	•	•	

▲ Not available with the pull through design on the geoCentric Mid Back.
 ♦ Standard on fabric upholstery. Only available on vinyl upholstery by request with a \$23 upcharge.
 * Uses the fabric Nytek in black. Vinyl upholstery is not permitted.

geoCentric™

Stacker Series

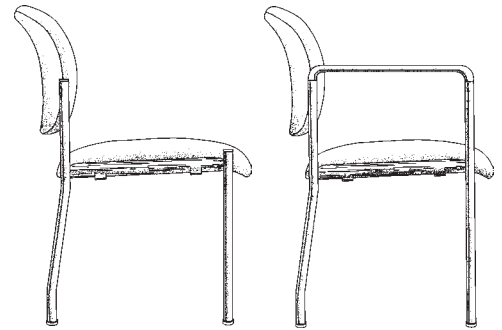

LIST PRICE	List Price	geo-STACKER	geo-STACKER-A
	• Grade 1/COM (yd)		\$576 (1 ¼)
• Grade 2		\$601	\$667
• Grade 3		\$626	\$692
• Grade 4		\$651	\$717
• Grade 5		\$676	\$742
• Leather		\$901	\$967

STANDARD SPECIFICATIONS	Backrest	geo-STACKER	geo-STACKER-A
	• Dual curve backrest • Concealed back brackets (except when upholstered in vinyl or leather)	• 18 ¼"w x 12 ½"h	• 18 ¼"w x 12 ½"h
Seat			
• Dual curve waterfall seat • Seat pan • Seat height	• 18 ½"w x 19 ½"d 17"h	• 18 ½"w x 19 ½"d 17"h	• 18 ½"w x 19 ½"d 17"h
Frame			
• 14 Gauge, ⅞" steel tube frame • Kick back legs for stability with durable custom glides • Black textured semi-gloss powder coat paint • Glass-filled nylon arms (black)	• • • N/A	• • • •	• • • •
Measurements			
• Overall dimensions • Boxed weight/size • Shipped 2 per carton	20"w x 19"d x 31"h 21 lbs/13 cu.ft 42 lbs	23 ½"w x 19"d x 31"h 24 lbs/13 cu.ft 48 lbs	

Stackable 6 units high without cart and 10 units high with cart

* Caster options should not be stacked.

OPTIONS	Base/Glides/Casters	Upcharge	geo-STACKER	geo-STACKER-A
	• Nylon stacker casters *	NSC	\$80	•
• Urethane stacker casters *	USC	\$100	•	•
Additional Options				
• Ganging brackets	GB	\$50	•	•
• Cart (23"w x 29 ¾"l x 14 ¾"h)	CART	\$481	•	•

eCentric™ Executive

The name says it all.

The eCentric Executive series is designed to provide exceptional cushioned comfort with the ergonomic support required in a variety of office environments.

Versatile and adjustable, the eCentric Executive's durable design and pleasing aesthetic make the chair well suited for executive and management offices, boardrooms and conference rooms.



eCentric™ Executive Synchro Glide Series

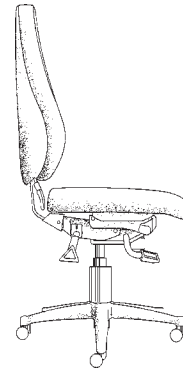

eCentric Executive Back

RECOMMENDED ARMS



TC Armrest Height & Lateral Adjustable TCL \$509

TC Armrest Height & Swivel Adjustable TC360 \$509

TC Armrest Height, Lateral & Swivel TCL360 \$549

For specifications, illustrations and additional arm options, see pages 69-71.

SEAT SIZE OPTIONS

Small 24CSS N/C
(20"w x 17"d)

Small Heavy Duty SSHD
\$129 (24"w x 19"d)

Large Heavy Duty LSHD
\$129 (24"w x 21"d)

Plus Size 24CPS
\$92 (22"w x 21"d)

Extra Wide 24CXW
\$92 (22"w x 19"d)

For graded in upholstery choices see page 78.

CONSIDER ADDING

Leg Rest LR \$375 (Grade 1)
For specifications, see page 73.

LIST PRICE	List Price	e-EXEC-SG
	<ul style="list-style-type: none"> Grade 1/COM (yd) Grade 2 Grade 3 Grade 4 Grade 5 Leather Match Leather 	<ul style="list-style-type: none"> \$1,877 (2 ½) \$1,917 \$1,957 \$1,997 \$2,037 \$2,462 \$2,787

STANDARD SPECIFICATIONS	Backrest	e-EXEC-SG
	<ul style="list-style-type: none"> 5" Patented back height adjustment system Fully upholstered dual curve backrest 	<ul style="list-style-type: none"> 21"w* x 26"h
	Seat	
<ul style="list-style-type: none"> Dual density polyurethane foam Eight ply hardwood seat structure Tailored upholstery on seat pan 	<ul style="list-style-type: none"> 20"w x 19"d 	
	Synchro Glide Mechanism	
<ul style="list-style-type: none"> Seat tilt lock out Free float Independent back angle adjustment Synchro 2:1 ratio Adjustable spring tension 2 ½" Depth adjustable seat slider 	<ul style="list-style-type: none"> 	
	Pneumatic Lift (seat height)	
<ul style="list-style-type: none"> 125 mm pneumatic lift (19"-24") 	<ul style="list-style-type: none"> 	
	Base	
<ul style="list-style-type: none"> 27" Hercules glass reinforced nylon base 5 Dual wheel nylon casters 	<ul style="list-style-type: none"> 	
	Measurements	
<ul style="list-style-type: none"> Boxed weight/size 	<ul style="list-style-type: none"> 63 lbs/11.7 cu.ft 	

OPTIONS	Seat	Upcharge	
	<ul style="list-style-type: none"> Triple density foam (adds ¼" to seat width & depth) Non-tailored seat pan 	TDF NTS	\$76 N/C
	Base/Glides/Casters		
<ul style="list-style-type: none"> 26" Polished aluminum base Silver accent casters Dual wheel urethane casters Single wheel nylon casters Single wheel urethane casters 2 ¼" Glides 	26PB CAC UC SW SWU 2G	\$198 \$113 \$54 \$74 \$82 N/C	
	Lifts (seat height)		
<ul style="list-style-type: none"> 80 mm pneumatic lift (18 ¼" - 21 ¼") 100 mm pneumatic lift (18 ¾" - 22 ¾") 140 mm pneumatic lift (20" - 25 ½") 	80MM 100MM 140MM	N/C N/C N/C	
	Additional Options		
<ul style="list-style-type: none"> Air lumbar Air thoracic Air thoracic and air lumbar eCentric Executive adjustable headrest * 	AL AT ATL 24AHR	\$189 \$222 \$370 \$466	

* Uses the fabric Nytek in black.Vinyl upholstery is not permitted.

eCentric™ Executive

Multi Tilt Series

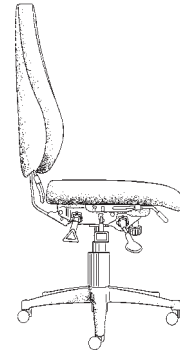

eCentric Executive Back

RECOMMENDED ARMS



TC Armrest Height & Lateral Adjustable TCL \$509

TC Armrest Height & Swivel Adjustable TC360 \$509

TC Armrest Height, Lateral & Swivel TCL360 \$549

For specifications, illustrations and additional arm options, see pages 69-71.

SEAT SIZE OPTIONS

Small 24CSS N/C (20"w x 17"d)

Small Heavy Duty SSHD \$129 (24"w x 19"d)

Large Heavy Duty LSHD \$129 (24"w x 21"d)

Plus Size 24CPS \$92 (22"w x 21"d)

Extra Wide 24CXW \$92 (22"w x 19"d)

For graded in upholstery choices see page 78.

CONSIDER ADDING

Leg Rest LR \$375 (Grade 1)
For specifications, see page 73.

LIST PRICE	List Price	e-EXEC-MT
	<ul style="list-style-type: none"> Grade 1/COM (yd) Grade 2 Grade 3 Grade 4 Grade 5 Leather Match Leather 	<ul style="list-style-type: none"> \$1,767 (2 ½) \$1,807 \$1,847 \$1,887 \$1,927 \$2,352 \$2,677

STANDARD SPECIFICATIONS	Backrest	e-EXEC-MT
	<ul style="list-style-type: none"> 5" Patented back height adjustment system Fully upholstered dual curve backrest 	<ul style="list-style-type: none"> 21"w* x 26"h
	Seat	
<ul style="list-style-type: none"> Dual density polyurethane foam Eight ply hardwood seat structure Tailored upholstery on seat pan 	<ul style="list-style-type: none"> 20"w x 19"d 	
	Multi Tilt Mechanism	
<ul style="list-style-type: none"> Infinite lock free float Back angle adjustment Adjustable spring tension Infinite forward tilt lock out 2 ½" Depth adjustable seat slider 	<ul style="list-style-type: none"> 	
	Pneumatic Lift (seat height)	
<ul style="list-style-type: none"> 125 mm pneumatic lift (17 ½"-22 ½") 	<ul style="list-style-type: none"> 	
	Base	
<ul style="list-style-type: none"> 27" Hercules glass reinforced nylon base 5 Dual wheel nylon casters 	<ul style="list-style-type: none"> 	
	Measurements	
<ul style="list-style-type: none"> Boxed weight/size 	<ul style="list-style-type: none"> 60 lbs/11.7 cu.ft 	

OPTIONS	Seat	Upcharge	
	<ul style="list-style-type: none"> Triple density foam (adds ¼" to seat width & depth) Non-tailored seat pan 	<ul style="list-style-type: none"> TDF NTS 	<ul style="list-style-type: none"> \$76 N/C
	Base/Glides/Casters		
<ul style="list-style-type: none"> 26" Polished aluminum base Silver accent casters Dual wheel urethane casters Single wheel nylon casters Single wheel urethane casters 2 ¼" Glides 	<ul style="list-style-type: none"> 26PB CAC UC SW SWU 2G 	<ul style="list-style-type: none"> \$198 \$113 \$54 \$74 \$82 N/C 	
	Lifts (seat height)		
<ul style="list-style-type: none"> 80 mm pneumatic lift (16 ½" - 19 ½") 100 mm pneumatic lift (17" - 20 ½") 140 mm pneumatic lift (18 ¾" - 24 ¼") 	<ul style="list-style-type: none"> 80MM 100MM 140MM 	<ul style="list-style-type: none"> N/C N/C N/C 	
	Additional Options		
<ul style="list-style-type: none"> Air lumbar Air thoracic Air thoracic and air lumbar eCentric Executive adjustable headrest * 24 Hour Multi Tilt Mechanism ** 	<ul style="list-style-type: none"> AL AT ATL 24AHR 24MT 	<ul style="list-style-type: none"> \$189 \$222 \$370 \$466 \$387 	

* Uses the fabric Nytek in black. Vinyl upholstery is not permitted.

** Warranted for 24 hour use up to a weight of 300 lbs.



eCentric™ Executive Plus Size Multi Tilt Series

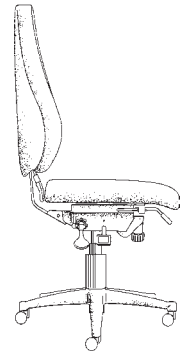

eCentric Executive Back

RECOMMENDED ARMS



TC Armrest Height & Lateral Adjustable TCL \$509

TC Armrest Height & Swivel Adjustable TC360 \$509

TC Armrest Height, Lateral & Swivel TCL360 \$549

For specifications, illustrations and additional arm options, see pages 69-71.

SEAT SIZE OPTIONS

Small 24CSS N/C (20" w x 17" d)

Small Heavy Duty SSHD \$129 (24" w x 19" d)

Large Heavy Duty LSHD \$129 (24" w x 21" d)

Extra Wide 24CXW \$92 (22" w x 19" d)

For graded in upholstery choices see page 78.

CONSIDER ADDING

Leg Rest LR \$375 (Grade 1)

For specifications, see page 73.

Warranted for users weighing up to 350 lbs

LIST PRICE	List Price	e-EXEC-PLUS-350MT
	<ul style="list-style-type: none"> Grade 1/COM (yd) Grade 2 Grade 3 Grade 4 Grade 5 Leather Match Leather 	<ul style="list-style-type: none"> \$2,250 (2 ½) \$2,290 \$2,330 \$2,370 \$2,410 \$2,835 \$3,160

STANDARD SPECIFICATIONS	Backrest	e-EXEC-PLUS-350MT
	<ul style="list-style-type: none"> 5" Patented back height adjustment system Heavy duty back bar support Molded polyurethane foam Fully upholstered dual curved backrest tapered width 	<ul style="list-style-type: none"> • • • 21" w x 26" h
	Seat	
<ul style="list-style-type: none"> Dual density polyurethane foam Eight ply hardwood seat structure Tailored upholstery on seat pan 	<ul style="list-style-type: none"> • • 22" w x 21" d 	
	Plus Size Multi Tilt Mechanism	
<ul style="list-style-type: none"> Back angle adjustment Adjustable spring tension Forward tilt lock out Infinite lock free float 2 ½" Depth adjustable seat slider 	<ul style="list-style-type: none"> • • • • • 	
	Pneumatic Lift (seat height)	
<ul style="list-style-type: none"> 125 mm heavy duty pneumatic lift (18 ½"-23 ½") 	<ul style="list-style-type: none"> • 	
	Base	
<ul style="list-style-type: none"> 27" Hercules glass reinforced nylon base 5 Dual wheel nylon casters 	<ul style="list-style-type: none"> • • 	
	Measurements	
<ul style="list-style-type: none"> Boxed weight/size 	<ul style="list-style-type: none"> 73 lbs/12.7 cu.ft 	

OPTIONS	Seat	Upcharge
	<ul style="list-style-type: none"> Triple density foam (adds ¼" to seat width & depth) 	TDF
	Base/Glides/Casters	
<ul style="list-style-type: none"> Silver accent casters 	CAC	\$113
<ul style="list-style-type: none"> Dual wheel urethane casters 	UC	\$54
<ul style="list-style-type: none"> Single wheel casters 	SW	\$74
<ul style="list-style-type: none"> Single wheel urethane casters 	SWU	\$82
<ul style="list-style-type: none"> 2 ¼" Glides 	2G	N/C
	Lifts (seat height)	
<ul style="list-style-type: none"> 80 mm heavy duty pneumatic lift (18" - 21") 	80MMHD	N/C
<ul style="list-style-type: none"> 100 mm heavy duty pneumatic lift (18 ¼" - 20 ¾") 	100MMHD	N/C
<ul style="list-style-type: none"> 140 mm heavy duty pneumatic lift (19" - 24 ½") 	140MMHD	N/C
	Additional Options	
<ul style="list-style-type: none"> Air lumbar 	AL	\$189
<ul style="list-style-type: none"> Air thoracic 	AT	\$222
<ul style="list-style-type: none"> Air thoracic and air lumbar 	ATL	\$370
<ul style="list-style-type: none"> eCentric Executive adjustable headrest * 	24AHR	\$466
<ul style="list-style-type: none"> Heavy Duty Task Intensive Mechanism 	TI	N/C
<ul style="list-style-type: none"> Non-tailored seat pan 	NTS	N/C

* Uses the fabric Nytek in black. Vinyl upholstery is not permitted.

eCentric™ Executive

Heavy Duty Series

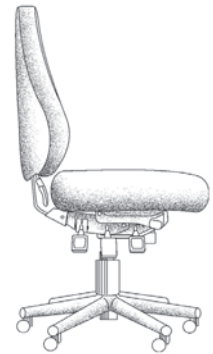

eCentric Executive Back

Warranted for users weighing up to 400 lbs

LIST PRICE	List Price	e-EXEC-HD
	<ul style="list-style-type: none"> Grade 1/COM (yd) Grade 2 Grade 3 Grade 4 Grade 5 Leather Match Leather 	<ul style="list-style-type: none"> \$2,704 (3) \$2,744 \$2,784 \$2,824 \$2,864 \$3,289 \$3,614



RECOMMENDED ARMS

4" Adjustable T-Arm
4ATANDD \$350

For specifications, illustrations and additional arm options, see pages 69-71.

SEAT SIZE OPTIONS

Small 24CSS N/C
(20"w x 17"d)

Small Heavy Duty SSHD
\$129 (24"w x 19"d)

Plus Size 24CPS
\$92 (22"w x 21"d)

Extra Wide 24CXW
\$92 (22"w x 19"d)

For graded in upholstery choices see page 78.

CONSIDER ADDING

Leg Rest LR \$375 (Grade 1)
For specifications, see page 73.

STANDARD SPECIFICATIONS	Backrest	e-EXEC-HD
	<ul style="list-style-type: none"> 5" Patented back height adjustment system Heavy duty back bar support Molded polyurethane foam Fully upholstered dual curved backrest 	<ul style="list-style-type: none"> • • • 21"w x 26"h
	Seat	
<ul style="list-style-type: none"> Heavy duty polyurethane foam Tailored upholstery on seat pan 	<ul style="list-style-type: none"> • 24"w x 21"d 	
	Plus Size Multi Tilt Mechanism	
<ul style="list-style-type: none"> Back angle adjustment Adjustable spring tension Forward tilt lock out Infinite lock free float 2 1/2" Depth adjustable seat slider 	<ul style="list-style-type: none"> • • • • • 	
	Pneumatic Lift (seat height)	
<ul style="list-style-type: none"> 100mm high pressure, high capacity cylinder (18 3/4"-22 1/4") 	<ul style="list-style-type: none"> • 	
	Base	
<ul style="list-style-type: none"> 26" Steel base Bariatric heavy duty casters 	<ul style="list-style-type: none"> • • 	
	Measurements	
<ul style="list-style-type: none"> Boxed weight/size (ships in two boxes) 	106 lbs/17 cu.ft	

OPTIONS	Additional Options	Upcharge
	<ul style="list-style-type: none"> Air lumbar Air thoracic Air thoracic and air lumbar eCentric Executive adjustable headrest * Heavy Duty Task Intensive Mechanism 30" Steel base Dual wheel bariatric casters Non-tailored seat pan 	<ul style="list-style-type: none"> AL AT ATL 24AHR TI 30SB DWBC NTS

* Uses the fabric Nytek in black.Vinyl upholstery is not permitted.

eCentric™ Executive Boardroom Series

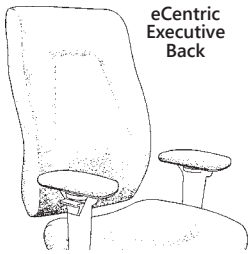
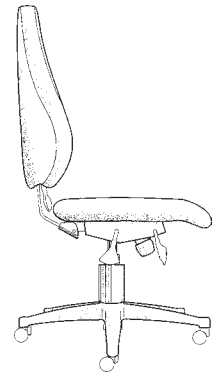

eCentric Executive Back

RECOMMENDED ARMS

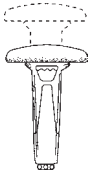

4" Adjustable T-Arm
4ATAOTNDD
\$350

For specifications, illustrations and additional arm options, see pages 69-71.

SEAT SIZE OPTIONS

Small 24CSS N/C
(20"w x 17"d)

Small Heavy Duty SSHD
\$129 (24"w x 19"d)

Large Heavy Duty LSHD
\$129 (24"w x 21"d)

Plus Size 24PCS
\$92 (22"w x 21"d)

Extra Wide 24CXW
\$92 (22"w x 19"d)

For graded in upholstery choices see page 78.

CONSIDER ADDING

Leg Rest LR \$375 (Grade 1)
For specifications, see page 73.

LIST PRICE	List Price	e-EXEC-BR
	<ul style="list-style-type: none"> Grade 1/COM (yd) Grade 2 Grade 3 Grade 4 Grade 5 Leather Match Leather 	<ul style="list-style-type: none"> \$1,487 (3) \$1,527 \$1,567 \$1,607 \$1,647 \$2,072 \$2,397

STANDARD SPECIFICATIONS	Backrest	e-EXEC-BR
	<ul style="list-style-type: none"> 5" Patented back height adjustment system Fully upholstered dual curve backrest 	<ul style="list-style-type: none"> 21"w* x 26"h
STANDARD SPECIFICATIONS	Seat	
	<ul style="list-style-type: none"> Dual density polyurethane foam Eight ply hardwood seat structure Tailored upholstery on seat pan 	<ul style="list-style-type: none"> 20"w x 19"d
STANDARD SPECIFICATIONS	Boardroom Mechanism	
	<ul style="list-style-type: none"> Single lock free float Seat height Adjustable spring tension 	<ul style="list-style-type: none">
STANDARD SPECIFICATIONS	Pneumatic Lift (seat height)	
	<ul style="list-style-type: none"> 125 mm pneumatic lift (17 ½"-22 ½") 	<ul style="list-style-type: none">
STANDARD SPECIFICATIONS	Base	
	<ul style="list-style-type: none"> 26" Glass reinforced nylon base 5 Dual wheel nylon casters 	<ul style="list-style-type: none">
STANDARD SPECIFICATIONS	Measurements	
	<ul style="list-style-type: none"> Boxed weight/size 	60 lbs/11.7 cu.ft

OPTIONS	Seat	Upcharge										
	<ul style="list-style-type: none"> Triple density foam (adds ¼" to seat width & depth) Non-tailored seat pan 	TDF		\$76								
OPTIONS	Base/Glides/Casters											
	<ul style="list-style-type: none"> 26" Polished aluminum base Silver accent casters Dual wheel urethane casters Single wheel nylon casters Single wheel urethane casters 2 ¾" Glides 	26PB	CAC	UC	SW	SWU	2G	\$198	\$113	\$54	\$74	\$82
OPTIONS	Lifts (seat height)											
	<ul style="list-style-type: none"> 80 mm pneumatic lift (18 ¾" - 21 ¾") 100 mm pneumatic lift (18 ¾" - 22 ¾") 140 mm pneumatic lift (20" - 25 ½") 	80MM	100MM	140MM	N/C	N/C	N/C					
	Additional Options											
<ul style="list-style-type: none"> Air lumbar Air thoracic Air thoracic and air lumbar eCentric Executive adjustable headrest * 	AL	AT	ATL	24AHR	\$189	\$222	\$370	\$466				

* Uses the fabric Nytek in black.Vinyl upholstery is not permitted.

Saffron

A high quality,
cost-effective solution

Built using the same high quality materials used in all ergoCentric chair lines, the Saffron series offers a cost-effective and comfortable solution for ergonomic task seating.

The Saffron series is designed with all the features ergonomists demand: quality materials, quality workmanship and ergonomic function. In combination, these features are designed to maximize both health and productivity.



Saffron R

Multi Tilt Series

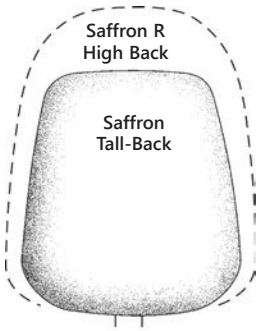
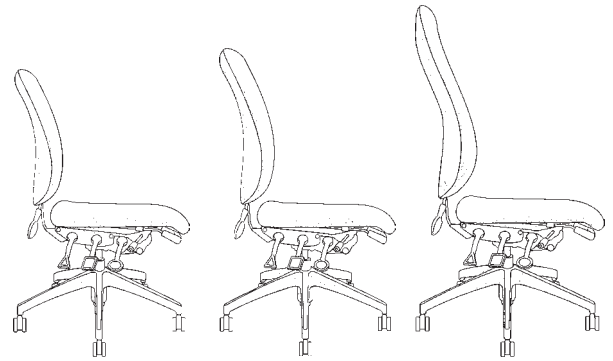

RECOMMENDED ARMS



For specifications, illustrations and additional arm options, see pages 69-71.

SEAT SIZE OPTIONS

- Extra Small XSS** \$92 (17 ½" w x 15 ½" d)
- Small SS** N/C (18 ½" w x 17" d)
- Plus Size PS** \$92 (22" w x 19" d)
- Extra Long XLS** \$92 (20" w x 21" d)
- Extra Deep XPS** \$92 (22" w x 21" d)

For graded in upholstery choices see page 78.

LIST PRICE	List Price	SAF-MBR-MT	SAF-TBR-MT	SAF-HBR-MT
	<ul style="list-style-type: none"> • Grade 1/COM (yd) • Grade 2 • Grade 3 • Grade 4 • Grade 5 • Back Cap Standard with Vinyl, PVC-free (vinyl-like) Upholsteries 	\$1,096 (1 ½)	\$1,128 (2)	\$1,263 (2)
		\$1,121	\$1,158	\$1,298
		\$1,146	\$1,188	\$1,333
		\$1,171	\$1,218	\$1,368
		\$1,196	\$1,248	\$1,403
		(\$17)	N/A	N/A

STANDARD SPECIFICATIONS	Backrest	SAF-MBR-MT	SAF-TBR-MT	SAF-HBR-MT
	<ul style="list-style-type: none"> • Fully upholstered dual curve backrest • 5" back height adjustment system 	17" w x 19" h	17" w x 21" h	19" w x 25" h
Seat				
<ul style="list-style-type: none"> • Dual density molded polyurethane foam • Eight ply hardwood seat structure seat pan • Tailored upholstery on seat pan* 	20" w x 19" d	20" w x 19" d	20" w x 19" d	
Multi Tilt Mechanism				
<ul style="list-style-type: none"> • Infinite lock free float • Back angle adjustment • Adjustable spring tension • Infinite forward tilt lock out • 2 ½" Depth adjustable seat slider 	•	•	•	
Pneumatic Lift (seat height)				
<ul style="list-style-type: none"> • 125 mmLT pneumatic lift (16" - 20 ½") 	•	•	•	
Base				
<ul style="list-style-type: none"> • 26" Glass reinforced nylon mid-profile base • 5 Dual wheel nylon casters 2 	•	•	•	
Measurements				
<ul style="list-style-type: none"> • Boxed weight/size 	48 lbs/6.7 cu.ft	51 lbs/10 ¾ cu.ft	55 lbs/11.7 cu.ft	

OPTIONS	Seat	Upcharge	SAF-MBR-MT	SAF-TBR-MT	SAF-HBR-MT
	<ul style="list-style-type: none"> • Energy absorbant memory foam • Triple density foam (adds ¼" to seat width & depth) • Non-tailored seat pan 	EA	\$92	•	•
	TDF	\$76	•	•	•
	NTS	N/C	•	•	•
Base/Glides/Casters					
<ul style="list-style-type: none"> • 26" Polished aluminum base • Dual wheel urethane casters • Single wheel nylon casters • Single wheel urethane casters • 2 ¼" Glides 	26PB	\$198	•	•	•
	UC	\$54	•	•	•
	SW	\$74	•	•	•
	SWU	\$82	•	•	•
	2G	N/C	•	•	•
Lifts (seat height)					
<ul style="list-style-type: none"> • 80 mm pneumatic lift (16 ¼" - 19 ¼") • 100 mm pneumatic lift (16 ¾" - 20 ¾") • 140 mm pneumatic lift (18" - 23 ¾") 	80MM	N/C	•	•	•
	100MM	N/C	•	•	•
	140MM	N/C	•	•	•
Additional Options					
<ul style="list-style-type: none"> • Adjustable headrest * • Air lumbar • Air thoracic • Air thoracic and air lumbar • Thoracic back support 	AHR	\$466	•	•	•
	AL	\$189	•	•	•
	AT	\$222	•	•	•
	ATL	\$370	N/A	•	•
	THB	\$92	•	•	•

♦ Standard on fabric upholstery. Only available on vinyl upholstery by request with a \$23 upcharge.
 * Uses the fabric Nytek in black. Vinyl upholstery is not permitted.

Saffron R

Counter Height Series



RECOMMENDED ARMS



3" Adjustable Swivel Arm
3SWVOT \$335



3" Adjustable T-Arm
3ATAOT \$208

For specifications, illustrations and additional arm options, see pages 69-71.

SEAT SIZE OPTIONS

Extra Small XSS \$92
(17 1/2"w x 15 1/2"d)

Small SS N/C
(18 1/2"w x 17"d)

Plus Size PS \$92
(22"w x 19"d)

Extra Long XLS \$92
(20"w x 21"d)

Extra Deep XPS \$92
(22"w x 21"d)

For graded in upholstery choices see page 78.

LIST PRICE	List Price	SAF-MBR-CH
	<ul style="list-style-type: none"> Grade 1/COM (yd) Grade 2 Grade 3 Grade 4 Grade 5 Back Cap Standard with Vinyl, PVC-free (vinyl-like) Upholsteries 	\$1,138 (1 1/2) \$1,163 \$1,188 \$1,213 \$1,238 (\$17)

STANDARD SPECIFICATIONS	Backrest	SAF-MBR-CH
	<ul style="list-style-type: none"> Fully upholstered dual curve backrest 5" back height adjustment system 	17"w x 19"h
Seat		
<ul style="list-style-type: none"> Dual density molded polyurethane foam Eight ply hardwood seat structure seat pan Tailored upholstery on seat pan* 	20"w x 19"d	
Counter Height Mechanism		
<ul style="list-style-type: none"> Independent back angle adjustment Fixed seat Seat height 		
Pneumatic Lift (seat height)		
<ul style="list-style-type: none"> 200 mm pneumatic lift (23" - 29 1/2") 		
Base		
<ul style="list-style-type: none"> 26" Glass reinforced nylon mid-profile base 20" diameter aluminum, height adjustable footing; 1 3/4" foot platform 2 1/4" Glides 		
Measurements		
<ul style="list-style-type: none"> Boxed weight/size 		55 lbs/11.7 cu.ft

OPTIONS	Seat	Upcharge
	<ul style="list-style-type: none"> Energy absorbant memory foam Triple density foam (adds 3/4" to seat width & depth) Non-tailored seat pan 	EA TDF NTS
Base / Glides / Casters		
<ul style="list-style-type: none"> Lock-on urethane casters Lock-off urethane casters Dual wheel nylon casters Dual wheel urethane casters Single wheel nylon casters Single wheel urethane casters 	LON LOF NC UC SW SWU	\$188 \$89 N/C \$54 \$74 \$82
Lifts (seat height)		
<ul style="list-style-type: none"> 157 mm pneumatic lift (18 3/4" - 23 3/4") 267 mm pneumatic lift (24 3/4" - 34 1/4") 	157MM 267MM	N/C \$8
Mechanisms		
<ul style="list-style-type: none"> Modified Multi Tilt Mechanism (Seat slider, height and back angle adjustment only) Dedicated Task 2 Mechanism 	MT DT2	\$171 N/C
Additional Options		
<ul style="list-style-type: none"> Adjustable headrest * Air lumbar Air thoracic Air thoracic and air lumbar Thoracic back support 	AHR AL AT ATL THB	\$466 \$189 \$222 \$370 \$92

* Standard on fabric upholstery. Only available on vinyl upholstery by request with a \$23 upcharge.
* Uses the fabric Nytek in black. Vinyl upholstery is not permitted.

ecoCentric™ Mesh

Breathable and comfortable.
The perfect combination.

ecoCentric Mesh chairs deliver a high quality mesh back with four inches of lumbar adjustment. With an airflow seat option unique to ergoCentric, the ecoCentric Mesh series delivers the benefits of airflow with the proven ergonomic comfort and support of foam and fabric.



ecoCentric™ Mesh

Multi Tilt Series



RECOMMENDED ARMS



3" Adjustable T-Arm
3ATAOT \$208

For specifications, illustrations and additional arm options, see pages 69-71.

SEAT SIZE OPTIONS

- Extra Small XSS** \$92
(17 ½" w x 15 ½" d)
- Small SS** N/C
(18 ½" w x 17" d)
- Standard LS** N/C
(20" w x 19" d)
- Plus Size PS** \$92
(22" w x 19" d)
- Extra Long XLS** \$92
(20" w x 21" d)

For graded in upholstery choices see page 78.

LIST PRICE	List Price	eco-MESH-MT
	• Grade 1/COM (yd) or Mesh Seat	\$1,118 (1)
	• Grade 2	\$1,133
	• Grade 3	\$1,148
	• Grade 4	\$1,163
	• Grade 5	\$1,178
	• Nymatrix (Nymatrix is for use on the seat only).**	\$1,223
• Leather	\$1,423	

STANDARD SPECIFICATIONS	Backrest	eco-MESH-MT
	• Breathable double mesh backrest.	19 ¾" w x 23" h
	• 4" of adjustable lumbar support	•
	Seat	
	• Molded polyurethane high resilient foam	•
	• Eight ply hardwood seat structure	•
	• Tailored upholstery on seat pan*	20" w x 19" d
Multi Tilt Mechanism		
• Infinite lock free float	•	
• Back angle adjustment	•	
• Adjustable spring tension	•	
• Infinite forward tilt lock out	•	
• 2 ½" Depth adjustable seat slider	•	
Pneumatic Lift (seat height)		
• 125 mmLT pneumatic lift (16" - 20 ½")	•	
Base		
• 26" Glass reinforced nylon mid-profile base	•	
• 5 Dual wheel nylon casters 2	•	
Measurements		
• Boxed weight/size	56 lbs/11.7 cu.ft	

OPTIONS	Seat	Upcharge	
	• Energy absorbant memory foam	EA	\$92
• Triple density foam (adds ¼" to seat width & depth)	TDF	\$76	
• Non-tailored seat pan	NTS	N/C	
• Single layer high-friction mesh seat (20" w x 18 ½" d)†	MS	N/C	
Base/Glides/Casters			
• 26" Polished aluminum base	26PB	\$198	
• 26" Glass reinforced nylon base	26NB	(\$12)	
• Silver accent casters	CAC	\$113	
• Dual wheel urethane casters	UC	\$54	
• Single wheel nylon casters	SW	\$74	
• Single wheel urethane casters	SWU	\$82	
• 2 ¼" Glides	2G	N/C	
Lifts (seat height)			
• 80 mm pneumatic lift (16 ¾" - 19 ¾")	80MM	N/C	
• 100 mm pneumatic lift (16 ¾" - 20 ¾")	100MM	N/C	
• 140 mm pneumatic lift (18" - 23 ¾")	140MM	N/C	
Additional Options			
• Tilt 2 Mechanism (Turn knob back height adjustment add 2 ¼")	TILT2	\$50	
• Tilt 2 Mechanism 2 ½" seat slider (adds 1 ½" to seat height)**	SSLF	\$123	
• Adjustable headrest*	AHR	\$466	

† Standard on fabric upholstery. Only available on vinyl upholstery by request with a \$23 upcharge.
 ‡ Comes standard with single layer high-friction mesh backrest.

* Uses black Nytek upholstery. Vinyl upholstery is not permitted.
 ** Only available with Tilt 2 option.

ecoCentric™ Mesh

Synchro Tilt Series

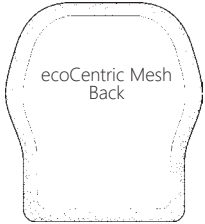
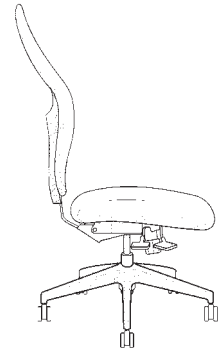

RECOMMENDED ARMS



3" Adjustable T-Arm
3ATAOT \$208

For specifications, illustrations and additional arm options, see pages 69-71.

SEAT SIZE OPTIONS

Extra Small XSS \$92
(17 ½"w x 15 ½"d)

Small SS N/C
(18 ½"w x 17"d)

Standard LS N/C
(20"w x 19"d)

Plus Size PS \$92
(22"w x 19"d)

Extra Long XLS \$92
(20"w x 21"d)

For graded in upholstery choices see page 78.

LIST PRICE	List Price	eco-MESH-ST
	• Grade 1/COM (yd) or Mesh Seat	\$1,032 (1)
	• Grade 2	\$1,047
	• Grade 3	\$1,062
	• Grade 4	\$1,077
	• Grade 5	\$1,092
	• Nymatrix (Nymatrix is for use on the seat only).**	\$1,137
	• Leather	\$1,292

STANDARD SPECIFICATIONS	Backrest	eco-MESH-ST
	• Breathable double mesh backrest.	19 ¼"w x 23"h
	• 4" of adjustable lumbar support	•
	Seat	•
	• Molded polyurethane high resilient foam	•
	• Eight ply hardwood seat structure	•
	• Tailored upholstery on seat pan*	20"w x 19"d
	Synchro Tilt Mechanism	•
	• Seat tilt lock out	•
	• Free float	•
• Synchro 2:1 ratio	•	
• Adjustable spring tension	•	
• 2" Depth adjustable seat slider	•	
Pneumatic Lift (seat height)	•	
• 125 mm pneumatic lift (16" - 20 ½")	•	
Base	•	
• 26" Glass reinforced nylon mid-profile base	•	
• 5 Dual wheel nylon casters 2	•	
Measurements	56 lbs/11.7 cu.ft	
• Boxed weight/size		

OPTIONS	Seat	Upcharge	
	• Energy absorbant memory foam	EA	\$92
	• Triple density foam (adds ¼" to seat width & depth)	TDF	\$76
	• Non-tailored seat pan	NTS	N/C
	Base/Glides/Casters		
	• 26" Polished aluminum mid-profile base	PMB	\$198
	• 26" Glass reinforced nylon base	26NB	(\$12)
	• Dual wheel nylon casters	NC	N/C
	• Dual wheel urethane casters	UC	\$54
	• Silver accent casters	CAC	\$113
	• Dual wheel urethane casters 2	UC2	\$54
	• 2 ¼" Glides	2G	N/C
	Lifts (seat height)		
	• 80 mm pneumatic lift (14 ¾" - 18")	80MM	N/C
	• 100 mm pneumatic lift (15 ¼" - 19")	100MM	N/C
	• 125 mmLT pneumatic lift (14 ¾" - 19")	125MMLT	N/C
	• 140 mm pneumatic lift (17" - 22 ¼")	140MM	N/C
	Additional Options		
	• Adjustable headrest*	AHR	\$466

♦ Standard on fabric upholstery. Only available on vinyl upholstery by request with a \$23 upcharge.
 † Comes standard with single layer high-friction mesh backrest.
 * Uses black Nytek upholstery. Vinyl upholstery is not permitted.

** Specifying Nymatrix on a seat with a different backrest upholstery is considered Combination Upholstery. To calculate the price of the chair, add the price for a full chair in the grade of the backrest material and a full chair in Nymatrix and divide by 2.

ecoCentric™ Mesh Boardroom Series

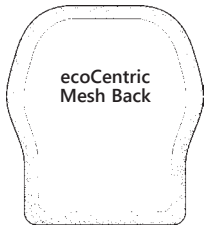
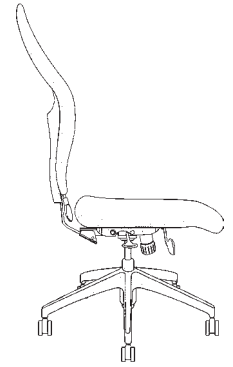

RECOMMENDED ARMS

For specifications, illustrations and additional arm options, see pages 69-71.



3" Adjustable T-Arm
3ATAOT \$208

For specifications, illustrations and additional arm options, see pages 69-71.

SEAT SIZE OPTIONS

Extra Small XSS \$92
(17 ½"w x 15 ½"d)

Small SS N/C
(18 ½"w x 17"d)

Standard LS
N/C (20"w x 19"d)

Plus Size PS \$92
(22"w x 19"d)

Extra Long XLS \$92
(20"w x 21"d)

For graded in upholstery choices see page 78.

LIST PRICE	List Price	eco-MESH-BR
	• Grade 1/COM (yd) or Mesh Seat	\$985 (1)
	• Grade 2	\$1,000
	• Grade 3	\$1,015
	• Grade 4	\$1,030
	• Grade 5	\$1,045
	• Nymatrix (Nymatrix is for use on the seat only).**	\$1,090
• Leather	\$1,290	

STANDARD SPECIFICATIONS	Backrest	eco-MESH-BR
	• Breathable double mesh backrest.	19 ¼"w x 23"h
	• 4" Of adjustable lumbar support	•
	Seat	
	• Molded polyurethane high resilient foam	•
	• Eight ply hardwood seat structure	•
	• Tailored upholstery on seat pan*	20"w x 19"d
	Boardroom Mechanism	
	• Seat height	•
	• Single lock free float	•
• Adjustable spring tension	•	
Pneumatic Lift (seat height)		
• 125 mm pneumatic lift (16 ¼" - 20 ¾")	•	
Base		
• 26" Glass reinforced nylon mid-profile base	•	
• 5 Dual wheel nylon casters 2	•	
Measurements		
• Boxed weight/size	56 lbs/11.7 cu.ft	

OPTIONS	Seat		Upcharge
	• Triple density foam seat (adds ¼" to seat width & depth)	TDF	\$76
	• Single layer high-friction mesh seat (20"w x 18 ½"d) [‡]	MS	N/C
	• Non-tailored seat pan	NTS	N/C
	Base/Glides/Casters		
	• 26" Polished aluminum base	26PB	\$198
	• 26" Glass reinforced nylon base	26NB	(\$12)
	• Silver accent casters	CAC	\$113
	• Dual wheel urethane casters	UC	\$54
	• Single wheel nylon casters	SW	\$74
	• Single wheel urethane casters	SWU	\$82
	• 2 ¼" Glides	2G	N/C
	Lifts (seat height)		
	• 80 mm pneumatic lift (15 ¼" - 18 ¼")	80MM	N/C
	• 100 mm pneumatic lift (15 ¾" - 19 ¾")	100MM	N/C
• 140 mm pneumatic lift (17" - 22 ¼")	140MM	N/C	
Additional Options			
• Adjustable headrest *	AHR	\$466	

- ♦ Standard on fabric upholstery. Only available on vinyl upholstery by request with a \$23 upcharge.
- ‡ Comes standard with single layer high-friction mesh backrest.
- * Uses black Nytek upholstery. Vinyl upholstery is not permitted.

iCentric™ Stacker

Convenient and durable.

The iCentric Stacker offers superior support to ensure your visitors are sitting comfortably. Ideal for settings that require occasional seating, the design of the back structure offers subtle lumbar support while the curved seat reduces pressure on the sitting bones and improves circulation.

With its modular construction and available options, it is well suited for private offices, waiting areas, cafeterias, classrooms and auditoriums.



iCentric™ Stacker Series

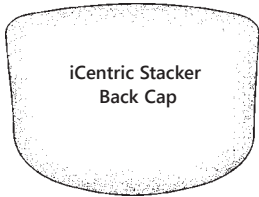
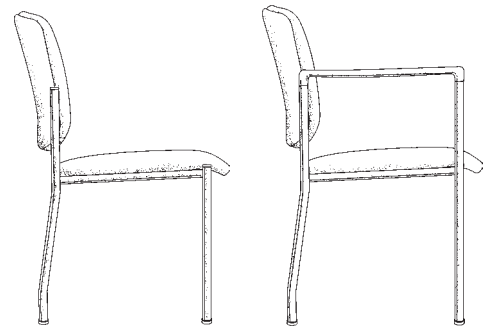

Standard on vinyl and PVC Free (vinyl like) upholsteries. Ideal for extra durability and cleanability.

Stackable 6 units high without cart and 10 units high with cart

* Caster options should not be stacked.

For graded in upholstery choices see page 78.

LIST PRICE	List Price	i-STACKER	i-STACKER-A
	• Grade 1/COM (yd)		\$594 (1 ¼)
• Grade 2		\$619	\$688
• Grade 3		\$644	\$713
• Grade 4		\$669	\$738
• Grade 5		\$694	\$763
• Leather		\$1,139	\$1,208

STANDARD SPECIFICATIONS	Backrest	i-STACKER	i-STACKER-A
	• Dual curve backrest • Concealed back brackets (except when upholstered in vinyl or leather)	• 19"w x 15 ½"h	• 19"w x 15 ½"h
Seat			
• Dual curve waterfall seat • Seat pan • Seat height	• 18 ½"w x 19 ½"d 17" h	• 18 ½"w x 19 ½"d 17" h	• 18 ½"w x 19 ½"d 17" h
Frame			
• 14 Gauge, ⅝" steel tube frame • Kick back legs for stability with durable custom glides • Black textured semi-gloss powder coat paint • Glass filled nylon arms (black)	• • • N/A	• • • •	• • • •
Measurements			
• Overall dimensions • Boxed weight/size • Shipped 2 per carton	20 ¾"w x 19 ½"d x 33"h 24 lbs/13 cu.ft 48 lbs	23 ¾"w x 19 ½"d x 33"h 27 lbs/13 cu.ft 54 lbs	

OPTIONS	Base/Glides/Casters	Upcharge	i-STACKER	i-STACKER-A
	• Nylon stacker casters • Urethane stacker casters	NSC USC	\$69 \$104	• •
Additional Options				
• Ganging brackets • Cart (23"w x 29 ¾"l x 14 ¾"h)**	GB CART	\$52 \$495	• •	• •

ergoForce™

The only office chair designed specifically for law enforcement.

The unique design of the ergoForce backrest accommodates the uniform requirements of professionals wearing a work belt, while providing them the freedom of movement required for multiple tasks.

Ideal for duty belts, the ergoForce is available in Dedicated Task, Multi Tilt, Synchro Glide and Plus Size models.



ergoForce™

Synchro Glide Series

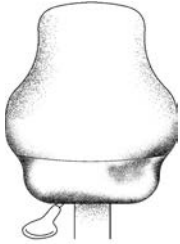
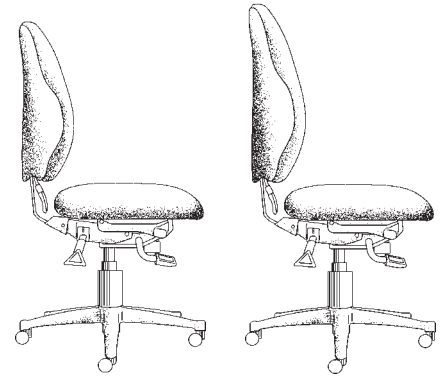

ergoForce Mid-Back with Abrasion-Resistant Nytek Strip

RECOMMENDED ARMS

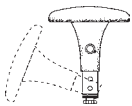

Swing away Adjustable T-Arm
SATAOT \$399
Ideal for duty belts

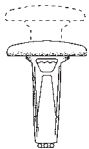

4" Adjustable T-Arm
4ATAOT \$317

For specifications, illustrations and additional arm options, see pages 69-71.

SEAT SIZE OPTIONS

- Extra Small XSS****** \$92
(17 ½" w x 15 ½" d)
- Small SS** N/C
(18 ½" w x 17" d)
- Plus Size PS** \$92
(22" w x 19" d)
- Extra Long XLS***** \$92
(20" w x 21" d)
- Extra Deep XPS** \$92
(22" w x 21" d)

For graded in upholstery choices see page 78.

LIST PRICE	List Price	eForce-MB-SG	eForce-HB-SG
	<ul style="list-style-type: none"> • Grade 1/COM (yd) • Grade 2 • Grade 3 • Grade 4 • Grade 5 • Open House fabric with Abrasion-Resistant Nytek Strip on backrest and back of seat.** 	\$1,401 (1 ½)	\$1,621 (2)

STANDARD SPECIFICATIONS	Backrest	eForce-MB-SG	eForce-HB-SG	
	<ul style="list-style-type: none"> • 5" Patented back height adjustment system • Fully upholstered dual curve backrest 	• 15 ½" w x 19" h	• 19" w x 26" h	
<th>Seat</th> <td> <ul style="list-style-type: none"> • Dual density molded polyurethane foam • Eight ply hardwood seat structure • Tailored upholstery on seat pan* </td> <td>• 20" w x 19" d</td> <td>• 20" w x 19" d</td>	Seat	<ul style="list-style-type: none"> • Dual density molded polyurethane foam • Eight ply hardwood seat structure • Tailored upholstery on seat pan* 	• 20" w x 19" d	• 20" w x 19" d
<th>Synchro Glide Mechanism</th> <td> <ul style="list-style-type: none"> • Seat tilt lock out • Free float • Independent back angle adjustment • Synchro 2:1 ratio • Adjustable spring tension • 2 ½" Depth adjustable seat slider </td> <td>• • • • • •</td> <td>• • • • • •</td>	Synchro Glide Mechanism	<ul style="list-style-type: none"> • Seat tilt lock out • Free float • Independent back angle adjustment • Synchro 2:1 ratio • Adjustable spring tension • 2 ½" Depth adjustable seat slider 	• • • • • •	• • • • • •
<th>Pneumatic Lift (seat height)</th> <td> <ul style="list-style-type: none"> • 125 mm pneumatic lift (18" - 23") </td> <td>•</td> <td>•</td>	Pneumatic Lift (seat height)	<ul style="list-style-type: none"> • 125 mm pneumatic lift (18" - 23") 	•	•
<th>Base</th> <td> <ul style="list-style-type: none"> • 27" Hercules glass reinforced nylon base • 5 Dual wheel nylon casters </td> <td>• •</td> <td>• •</td>	Base	<ul style="list-style-type: none"> • 27" Hercules glass reinforced nylon base • 5 Dual wheel nylon casters 	• •	• •
<th>Measurements</th> <td> <ul style="list-style-type: none"> • Boxed weight/size </td> <td>52 lbs/6.7 cu.ft</td> <td>57 lbs/11.7 cu.ft</td>	Measurements	<ul style="list-style-type: none"> • Boxed weight/size 	52 lbs/6.7 cu.ft	57 lbs/11.7 cu.ft

OPTIONS	Seat	Upcharge			
	<ul style="list-style-type: none"> • Energy absorbant memory foam • Triple density foam (adds ¼" To seat width & depth) • Non-tailored seat pan 	EA	\$92	\$76	
<th>Base / Glides / Casters</th> <td> <ul style="list-style-type: none"> • 26" Polished aluminum base • Silver accent casters • Dual wheel urethane casters • Single wheel nylon casters • Single wheel urethane casters • 2 ¼" Glides </td> <td>26PB CAC UC SW SWU 2G</td> <td>\$198 \$113 \$54 \$74 \$82 N/C</td> <td></td>	Base / Glides / Casters	<ul style="list-style-type: none"> • 26" Polished aluminum base • Silver accent casters • Dual wheel urethane casters • Single wheel nylon casters • Single wheel urethane casters • 2 ¼" Glides 	26PB CAC UC SW SWU 2G	\$198 \$113 \$54 \$74 \$82 N/C	
<th>Lifts (seat height)</th> <td> <ul style="list-style-type: none"> • 80 mm pneumatic lift (17 ¼" - 20 ¼") • 100 mm pneumatic lift (17 ½" - 21") • 140 mm pneumatic lift (19" - 24 ½") </td> <td>80MM 100MM 140MM</td> <td>N/C N/C N/C</td> <td></td>	Lifts (seat height)	<ul style="list-style-type: none"> • 80 mm pneumatic lift (17 ¼" - 20 ¼") • 100 mm pneumatic lift (17 ½" - 21") • 140 mm pneumatic lift (19" - 24 ½") 	80MM 100MM 140MM	N/C N/C N/C	
<th>Additional Options</th> <td> <ul style="list-style-type: none"> • Air lumbar • Air thoracic • Air thoracic and air lumbar (High-Back only) • Adjustable headrest * </td> <td>AL AT ATL AHR</td> <td>\$189 \$222 \$370 \$466</td> <td></td>	Additional Options	<ul style="list-style-type: none"> • Air lumbar • Air thoracic • Air thoracic and air lumbar (High-Back only) • Adjustable headrest * 	AL AT ATL AHR	\$189 \$222 \$370 \$466	

** Abrasion resistant Nytek Strip on bottom of backrest MB 5" h - HB 12" h
 **** 3" Adjustable T-Arms recommended with this option 3ATAOT
 *** Not available with seat slider option
 * Standard on fabric upholstery. Only available on vinyl upholstery by request with a \$23 upcharge.
 * Uses the fabric Nytek in black. Vinyl upholstery is not permitted.

ergoForce™

Multi Tilt Series

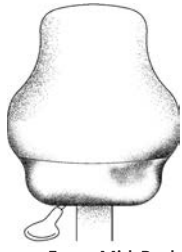
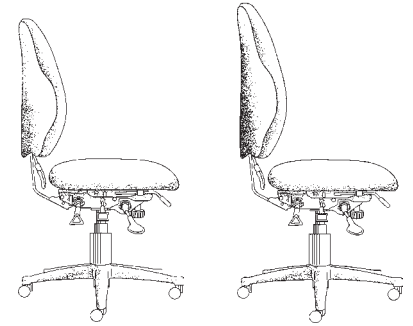

ergoForce Mid-Back with Abrasion-Resistant Nytek Strip

RECOMMENDED ARMS

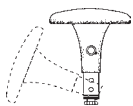

Swing away Adjustable T-Arm
SATAOT \$399
Ideal for duty belts

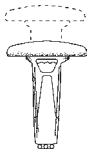

4\"/>

For specifications, illustrations and additional arm options, see pages 69-71.

SEAT SIZE OPTIONS

Extra Small XSS**** \$92
(17 ½\"/>

Small SS N/C
(18 ½\"/>

Plus Size PS \$92
(22\"/>

Extra Long XLS*** \$92
(20\"/>

Extra Deep XPS \$92
(22\"/>

For graded in upholstery choices see page 78.

LIST PRICE	List Price	eForce-MB-MT	eForce-HB-MT
	<ul style="list-style-type: none"> Grade 1/COM (yd) Grade 2 Grade 3 Grade 4 Grade 5 Open House fabric with Abrasion-Resistant Nytek Strip on backrest and back of seat.** 	\$1,289 (1 ½)	\$1,509 (2)
		\$1,319	\$1,544
		\$1,349	\$1,579
		\$1,379	\$1,614
		\$1,409	\$1,649
		\$1,399	\$1,644

STANDARD SPECIFICATIONS	Backrest	eForce-MB-MT	eForce-HB-MT
	<ul style="list-style-type: none"> 5\"/> 	•	•
<ul style="list-style-type: none"> Fully upholstered dual curve backrest 	15 ½\"/>	19\"/>	
Seat			
<ul style="list-style-type: none"> Dual density molded polyurethane foam Eight ply hardwood seat structure Tailored upholstery on seat pan* 	•	•	
	20\"/>	20\"/>	
Multi Tilt Mechanism			
<ul style="list-style-type: none"> Infinite lock free float Back angle adjustment Adjustable spring tension Infinite forward tilt lock out 2 ½\"/> 	•	•	
	•	•	
	•	•	
	•	•	
	•	•	
Pneumatic Lift (seat height)			
<ul style="list-style-type: none"> 125 mm pneumatic lift (16 ½\"/> 	•	•	
Base			
<ul style="list-style-type: none"> 27\"/> 	•	•	
<ul style="list-style-type: none"> 5 Dual wheel nylon casters 	•	•	
Measurements			
<ul style="list-style-type: none"> Boxed weight/size 	49 lbs/6.7 cu.ft	54 lbs/11.7 cu.ft	

OPTIONS	Seat	Upcharge
	<ul style="list-style-type: none"> Energy absorbant memory foam Triple density foam (adds ¼\"/> 	EA
<ul style="list-style-type: none"> Non-tailored seat pan 	TDF	\$76
	NTS	N/C
Base / Glides / Casters		
<ul style="list-style-type: none"> 26\"/> 	26PB	\$198
<ul style="list-style-type: none"> Silver accent casters 	CAC	\$113
<ul style="list-style-type: none"> Dual wheel urethane casters 	UC	\$54
<ul style="list-style-type: none"> Single wheel nylon casters 	SW	\$74
<ul style="list-style-type: none"> Single wheel urethane casters 	SWU	\$82
<ul style="list-style-type: none"> 2 ¼\"/> 	2G	N/C
Lifts (seat height)		
<ul style="list-style-type: none"> 80 mm pneumatic lift (15 ¾\"/> 	80MM	N/C
<ul style="list-style-type: none"> 100 mm pneumatic lift (16\"/> 	100MM	N/C
<ul style="list-style-type: none"> 140 mm pneumatic lift (17 ½\"/> 	140MM	N/C
Additional Options		
<ul style="list-style-type: none"> Air lumbar 	AL	\$189
<ul style="list-style-type: none"> Air thoracic 	AT	\$222
<ul style="list-style-type: none"> Air thoracic and air lumbar (High-Back only) 	ATL	\$370
<ul style="list-style-type: none"> Adjustable headrest * 	AHR	\$466

** Abrasion resistant Nytek Strip on bottom of backrest MB 5\"/>

**** 3\"/>

*** Not available with seat slider option

• Standard on fabric upholstery. Only available on vinyl upholstery by request with a \$23 upcharge.

* Uses the fabric Nytek in black. Vinyl upholstery is not permitted.

ergoForce™

24 Hour Multi Tilt Series

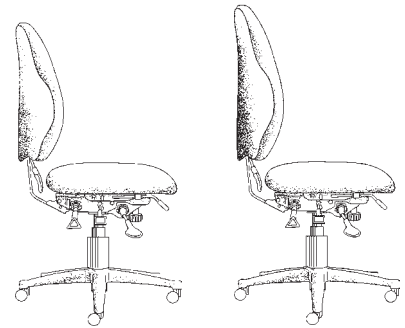

Warranted for 24 Hour multi shift applications of users weighing up to 300 lbs

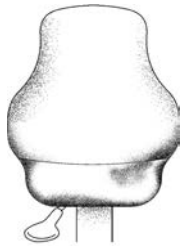

ergoForce Mid-Back with Abrasion-Resistant Nytek Strip

RECOMMENDED ARMS



4" Adjustable T-Arm
4ATAOT \$317

For specifications, illustrations and additional arm options, see pages 69-71.

SEAT SIZE OPTIONS

Extra Small XSS**** \$92
(17 ½"w x 15 ½"d)

Small SS N/C
(18 ½"w x 17"d)

Plus Size PS \$92
(22"w x 19"d)

Extra Long XLS*** \$92
(20"w x 21"d)

Extra Deep XPS \$92
(22"w x 21"d)

For graded in upholstery choices see page 78.

LIST PRICE	List Price	eForce-MB-24MT	eForce-HB-24MT
	• Grade 1/COM (yd)	\$1,684 (1 ½)	\$1,830 (2)
	• Grade 2	\$1,714	\$1,865
	• Grade 3	\$1,744	\$1,900
	• Grade 4	\$1,774	\$1,935
	• Grade 5	\$1,804	\$1,970
	• Open House fabric with Abrasion-Resistant Nytek Strip on backrest and back of seat.**	\$1,794	\$1,965

STANDARD SPECIFICATIONS	Backrest	eForce-MB-24MT	eForce-HB-24MT
	• 5" Patented back height adjustment system	•	•
	• Heavy duty back bar support	•	•
	• Molded polyurethane foam	•	•
	• Fully upholstered dual curved backrest	15 ½"w x 19"h	19"w x 26"h
	Seat		
	• Dual density molded polyurethane foam	•	•
	• Eight ply hardwood seat structure	•	•
	• Tailored upholstery on seat pan*	20"w x 19"d	20"w x 19"d
	24 Hour Multi Tilt Mechanism		
• Back angle adjustment	•	•	
• Adjustable spring tension	•	•	
• Forward tilt lock out	•	•	
• Infinite lock free float	•	•	
• 2 ½" Depth adjustable seat slider	•	•	
Pneumatic Lift (seat height)			
• 125 mm pneumatic lift (17 ½" - 22 ½")	•	•	
Base			
• 27" Hercules glass reinforced nylon base	•	•	
• 5 Dual wheel nylon casters	•	•	
Measurements			
• Boxed weight/size	67 lbs/6.7 cu.ft	72 lbs/11.7 cu.ft	

OPTIONS	Seat	Upcharge	
	• Energy absorbant memory foam	EA	\$92
• Triple density foam (adds ¼" to seat width & depth)	TDF	\$76	
• Non-tailored seat pan	NTS	N/C	
Base / Glides / Casters			
• Silver accent casters	CAC	\$113	
• Dual wheel urethane casters	UC	\$54	
• Single wheel nylon casters	SW	\$74	
• Single wheel urethane casters	SWU	\$82	
• 2 ¼" Glides	2G	N/C	
Lifts (seat height)			
• 80 mm pneumatic lift (17" - 20")	80MM	N/C	
• 100 mm pneumatic lift (17 ¾" - 20 ¾")	100MM	N/C	
• 140 mm pneumatic lift (18" - 23 ½")	140MM	N/C	
Additional Options			
• Air lumbar	AL	\$189	
• Air thoracic	AT	\$222	
• Air thoracic and air lumbar (High-Back only)	ATL	\$370	
• Adjustable headrest *	AHR	\$466	
• Heavy Duty Task Intensive Mechanism	TI	N/C	

** Abrasion resistant Nytek Strip on bottom of backrest MB 5"h - HB 12"h

**** 3" Adjustable T-Arms recommended with this option 3ATAOT

*** Not available with seat slider option

• Standard on fabric upholstery. Only available on vinyl upholstery by request with a \$23 upcharge.

* Uses the fabric Nytek in black.Vinyl upholstery is not permitted.



ergoForce™

Plus Size Multi Tilt Series

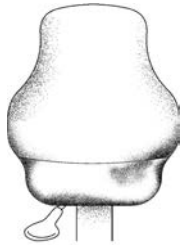
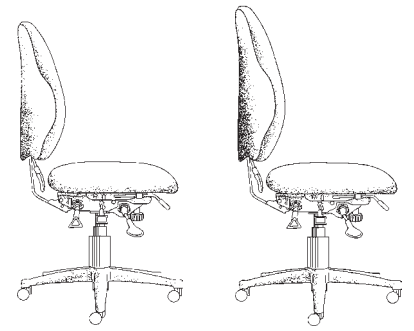

ergoForce Mid-Back with Abrasion-Resistant Nytek Strip

RECOMMENDED ARMS



4" Adjustable T-Arm
4ATAOT \$317

For specifications, illustrations and additional arm options, see pages 69-71.

SEAT SIZE OPTIONS

Extra Small XSS**** \$92
(17 ½" w x 15 ½" d)

Small SS N/C
(18 ½" w x 17" d)

Plus Size PS N/C
(22" w x 19" d)

Extra Long XLS*** \$92
(20" w x 21" d)

Extra Deep XPS \$92
(22" w x 21" d)

For graded in upholstery choices see page 78.

Warranted for users weighing up to 350 lbs

LIST PRICE	List Price	eForce-MB-PLUS-350MT	eForce-HB-PLUS-350MT
	<ul style="list-style-type: none"> Grade 1/COM (yd) Grade 2 Grade 3 Grade 4 Grade 5 Open House fabric with Abrasion-Resistant Nytek Strip on backrest and back of seat.** 	\$1,739 (2)	\$1,954 (2 ½)
		\$1,769	\$1,989
		\$1,799	\$2,024
		\$1,829	\$2,059
		\$1,859	\$2,094
		\$1,849	\$2,089

STANDARD SPECIFICATIONS	Backrest	eForce-MB-PLUS-350MT	eForce-HB-PLUS-350MT
	<ul style="list-style-type: none"> 5" Patented back height adjustment system Heavy duty back bar support Molded polyurethane foam Fully upholstered dual curved backrest 	• • • •	• • • •
	15 ½" w x 19" h	19" w x 26" h	
Seat	<ul style="list-style-type: none"> Dual density molded polyurethane foam Eight ply hardwood seat structure Tailored upholstery on seat pan* 	• • •	• • •
	22" w x 19" d	22" w x 19" d	
Plus size Multi Tilt Mechanism	<ul style="list-style-type: none"> Back angle adjustment Adjustable spring tension Forward tilt lock out Infinite lock free float 2 ½" Depth adjustable seat slider 	• • • • •	• • • • •
Pneumatic Lift (seat height)	<ul style="list-style-type: none"> 125 mm heavy duty pneumatic lift (17 ½" - 22 ½") 	•	•
Base	<ul style="list-style-type: none"> 27" Hercules glass reinforced nylon base 5 Dual wheel nylon casters 	• •	• •
Measurements	<ul style="list-style-type: none"> Boxed weight/size 	67 lbs/6.7 cu.ft	72 lbs/11.7 cu.ft

OPTIONS	Seat	Upcharge	
	<ul style="list-style-type: none"> Energy absorbant memory foam Triple density foam (adds ¼" to seat width & depth) Non-tailored seat pan 	EA TDF NTS	\$92 \$76 N/C
Base/Glides/Casters	<ul style="list-style-type: none"> Silver accent casters Dual wheel urethane casters Single wheel nylon casters Single wheel urethane casters 2 ¾" Glides 	CAC UC SW SWU 2G	\$113 \$54 \$74 \$82 N/C
Lifts (seat height)	<ul style="list-style-type: none"> 80 mm heavy duty pneumatic lift (17" - 20") 100 mm heavy duty pneumatic lift (17 ¼" - 20 ¾") 140 mm heavy duty pneumatic lift (18" - 23 ½") 	80MMHD 100MMHD 140MMHD	N/C N/C N/C
Additional Options	<ul style="list-style-type: none"> Adjustable headrest * Air lumbar Air thoracic Air thoracic and air lumbar (High-Back only) Heavy Duty Task Intensive Mechanism 	AHR AL AT ATL TI	\$466 \$189 \$222 \$370 N/C

** Abrasion resistant Nytek Strip on bottom of backrest MB 5" h - HB 12" h

**** 3" Adjustable T-Arms recommended with this option 3ATAOT

*** Not available with seat slider option

* Standard on fabric upholstery. Only available on vinyl upholstery by request with a \$23 upcharge.

* Uses the fabric Nytek in black. Vinyl upholstery is not permitted.

24Centric™

Warranted for continuous
24 hour use.

The 24Centric series is designed to provide exceptional cushioned comfort with the ergonomic support needed for a variety of office tasks. Versatile in its capabilities, the 24Centric's durable design and pleasing aesthetic make the chair well suited for control room use and other 24 hour environments.



24Centric™

24 Hour Multi Tilt Series

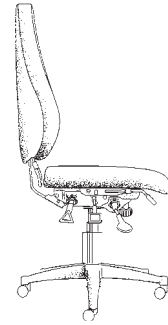

24Centric Backrest

RECOMMENDED ARMS



4" Adjustable T-Arm
4ATAOT \$317

For specifications, illustrations and additional arm options, see pages 69-71.

SEAT SIZE OPTIONS

Small 24CSS N/C
(20"w x 17"d)

Large Heavy Duty LSHD
\$129 (24"w x 21"d)

Plus Size 24CPS \$92
(22"w x 21"d)

Extra Wide 24CXW \$92
(22"w x 19"d)

For graded in upholstery choices see page 78.

CONSIDER ADDING

Leg Rest LR \$375 (Grade 1)
For specifications, see page 73.

LIST PRICE	List Price	24C-24MT
	• Grade 1/COM (v)	\$2,161 (2 ½)
	• Grade 2	\$2,201
	• Grade 3	\$2,241
	• Grade 4	\$2,281
	• Grade 5	\$2,321
	• Leather Match	\$2,706
	• Leather	\$3,031

STANDARD SPECIFICATIONS	Backrest	24C-24MT
	• 5" Patented back height adjustment system	•
	• Bolstered fabricated polyurethane foam	•
	• Fully upholstered dual curved backrest	21"w* x 26"h
	Seat	•
	• Dual density polyurethane foam	•
	• Eight ply hardwood seat structure	20"w x 19"d
	• Tailored upholstery on seat pan	•
24 Hour Multi Tilt Mechanism	•	
• Back angle adjustment	•	
• Adjustable spring tension	•	
• Forward tilt lock out	•	
• Infinite lock free float	•	
• 2 ½" Depth adjustable seat slider	•	
Pneumatic Lift (seat height)	•	
• 125 mm pneumatic lift (17 ½" - 23 ½")	•	
Base	•	
• 27" Hercules glass reinforced nylon base	•	
• 5 Dual wheel nylon casters	•	
Measurements	71 lbs/11.7 cu.ft	
• Boxed weight/size		

OPTIONS	Seat		Upcharge
	• Triple density foam (adds ½" to seat width & ¾" depth)	TDF	
Base/Glides/Casters			
• Silver accent casters	CAC		\$113
• Dual wheel urethane casters	UC		\$54
• Single wheel nylon casters	SW		\$74
• Single wheel urethane casters	SWU		\$89
• 2 ¾" Glides	2G		N/C
Lifts (seat height)			
• 80 mm pneumatic lift (18" - 21")	80MM		N/C
• 100 mm pneumatic lift (18 ¾" - 21 ¾")	100MM		N/C
• 140 mm pneumatic lift (19" - 24 ½")	140MM		N/C
Additional Options			
• Air lumbar	AL		\$189
• Air thoracic	AT		\$222
• Air thoracic and air lumbar	ATL		\$370
• 24Centric adjustable headrest *	24AHR		\$466
• Heavy Duty Task Intensive Mechanism	TI		N/C
• Non-tailored seat pan	NTS		N/C

Warranted for 24 hour multi shift applications of users weighing up to 300lbs

* Uses the fabric Nytek in black.Vinyl upholstery is not permitted.



STOOLS & SPECIALTY SEATING

ergoCentric Sit-Stand

Sit Stand Series

With its innovative design, the ergoCentric Sit Stand is the ultimate sit-stand chair combining three chairs in one: providing a sit-stand, a sit-stand with backrest, or a counter or desk height task chair.

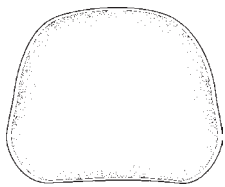
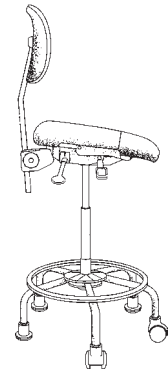

the ergoCentric Sit Stand Back

The ergoCentric Sit Stand is three chairs in one seating system.

- Use as a sit stand with our durable No-Slip Strip
- Use as a sit stand with back support
- Use as a counter height task chair

LIST PRICE	List Price	TESS-CH	TESS-BL
	• The ergoCentric Sit Stand Chrome Package (Staccato with SPU Strip*)	\$1,384 (1 ¼)	N/A
• The ergoCentric Sit Stand Black Package (Staccato with SPU Strip*)	N/A		\$1,286

STANDARD SPECIFICATIONS	Backrest	TESS-CH	TESS-BL
	• Fully upholstered backrest	14" w x 10" h	14" w x 10" h
• 4" of back height adjustment with chrome back bar	•	N/A	
• 4" of back height adjustment with black back bar	N/A	•	
Seat			
• Upholstered seat with dual density molded polyurethane foam with 5" ergoCentric+Guard High Friction No-Slip Strip*	•	•	
• Standard extra small seat pan	17 ½" w x 15 ½" d	17 ½" w x 15 ½" d	
Tube Mechanism			
• 1 Lever for both seat and back angle adjustment	•	•	
• Back pivot	•	•	
• Back height adjustment	•	•	
• Seat height	•	•	
Pneumatic Lift			
• 200 mm chrome knurled pneumatic lift (21" - 33") **	•	N/A	
• 200 mm black knurled pneumatic lift (21" - 33")**	N/A	•	
Base			
• 22" Chrome base	•	N/A	
• 22" Black base	N/A	•	
• 18" Oval tube footing built in for durability (height from floor 8 ½")	•	•	
• 2 X dual wheel nylon 2 ¼" casters and 3 x 2 ¼" glides	•	•	
Measurements			
• Boxed weight/size	35 lbs/5.2 cu.ft	35 lbs/5.2 cu.ft	

OPTIONS	Glides/Casters	Upcharge	
	• 5 X 2 ¼" glides	2G	N/C
• 5 X 2" No slip glides	NSG	\$125	
• 2 X dual wheel urethane casters with 3 x 2 ¼" glides	2UC32G	\$21	
Additional Options			
• 3-in-1 high back (17"w x 15"h)	3N1HB	\$159	
• 3-in-1 small seat (18 ½"w x 17"d)	SS	\$46	

* **No-Slip Strip** Formulated to reduce the possibility of slipping, the ergoCentric+Guard High Friction No-Slip Strip provides the best traction for individuals who sit at an angle. Available in Onyx (black) and Sapphire (blue).

** 7 ½" of pneumatic height adjustment

3-in-1 Sit Stand Series

The 3-in-1 Sit Stand is the most user friendly sit stand available with three seating options and a unique No-Slip Strip. An ideal solution for individuals who require a variety of seating positions during their day – standing, perching to sitting – or for those who use a height adjustable work station.

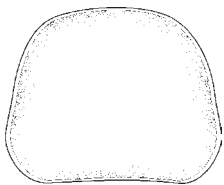
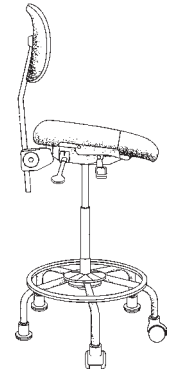

3-In-1 Sit Stand Back

The 3-In-1 Sit Stand is three chairs in one seating system.

- Use as a sit stand with our durable No-Slip Strip
- Use as a sit stand with back support
- Use as a counter height task chair

LIST PRICE	3-In-1 Sit Stand	
	<ul style="list-style-type: none"> • Staccato fabric with ergoCentric+Guard™ High Friction No-Slip Strip* (yd) • Frixion fabric 	<ul style="list-style-type: none"> • \$1,209 (1 ¼) • \$1,185
STANDARD SPECIFICATIONS	3-In-1 Sit Stand	
	Backrest	14" w x 10" h
	<ul style="list-style-type: none"> • Fully upholstered backrest • 4" of back height adjustment 	•
	Seat	•
	<ul style="list-style-type: none"> • Upholstered seat with dual density molded polyurethane foam with 5" ergoCentric+Guard High Friction No-Slip Strip* • Standard extra small seat pan 	17 ½" w x 15 ½" d
	Tube Mechanism	•
	<ul style="list-style-type: none"> • 1 Lever for both seat and back angle adjustment • Back pivot • Back height adjustment • Seat height 	•
	Pneumatic Lift	•
	<ul style="list-style-type: none"> • 200 mm chrome knurled pneumatic lift (21" - 33") ** 	•
	Base	•
<ul style="list-style-type: none"> • 22" Chrome base • 18" Oval tube footring built in for durability (height from floor 8 ½") • 2 X dual wheel nylon 2 ¼" casters and 3 x 2 ¼" glides 	•	
Measurements	35 lbs/5.2 cu.ft	

OPTIONS	Upcharge	
	Glides/Casters	
<ul style="list-style-type: none"> • 5 X 2 ¼" glides 	2G	N/C
<ul style="list-style-type: none"> • 5 X 2" No slip glides 	NSG	\$133
<ul style="list-style-type: none"> • 2 X dual wheel urethane casters with 3 x 2 ¼" glides 	2UC32G	\$22
Additional Options		
<ul style="list-style-type: none"> • 3-in-1 high back (17"w x 15"h) 	3N1HB	\$166
<ul style="list-style-type: none"> • 3-in-1 small seat (18 ½"w x 17"d) 	SS	\$50
<ul style="list-style-type: none"> • 200 mm black knurled pneumatic lift (19 ¼" - 35 ½")** 	200MMPKBL	\$47
<ul style="list-style-type: none"> • 22" 3-in-1 black base 	22BLKFR	N/C

* **No-Slip Strip** Formulated to reduce the possibility of slipping, the ergoCentric+Guard High Friction No-Slip Strip provides the best traction for individuals who sit at an angle. Available in Onyx (black) and Sapphire (blue).

** 7 ½" of pneumatic height adjustment

Ergo Scooter Stool Series

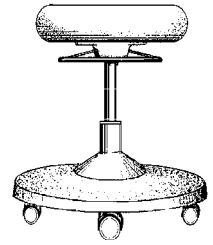

SEAT OPTIONS



IC plus Seat Style

LIST PRICE	List Price	SCOOTER
	• Grade 1/COM	\$578
	• Grade 2	\$598
	• Grade 3	\$618
	• Grade 4	\$638
	• Grade 5	\$658
	• Grade 12/ IC plus*	\$798

STANDARD SPECIFICATIONS	Seat	SCOOTER
	<ul style="list-style-type: none"> • 16" Diameter upholstered seat (fabric, vinyl or IC plus) • Height adjustment • Easy to use ring type height adjustment activator 	• • •
	Pneumatic Lift (seat height) <ul style="list-style-type: none"> • 125 mm pneumatic lift (14 ½"-19 ½") 	•
	Base <ul style="list-style-type: none"> • 16" Diameter Solid Base • 6 Dual wheel nylon casters 	• •
	Measurements <ul style="list-style-type: none"> • Boxed weight/size 	18 ½ lbs/5.2 cu.ft

OPTIONS	Base/Glides/Casters	UPCHARGE	
	• 6 Lock-on urethane casters	LON6	\$219
	• 6 Lock-off urethane casters	LOF6	\$110
	• 6 Dual wheel urethane casters	UC6	\$63
	• 6, 2 ¼" Glides	2G6	N/C
	Lifts (seat height)		
	• 70 mmlt pneumatic lift (12 ½" - 15 ½")	70MMLT	N/C
	• 70 mm pneumatic lift (13" - 16")	70MM	N/C
	• 80 mm pneumatic lift (13 ½" - 16 ½")	80MM	N/C
	• 100 mm pneumatic lift (14" - 17 ½")	100MM	N/C
	• 140 mm pneumatic lift (15" - 20 ½")	140MM	N/C
	• 157 mm pneumatic lift (16 ½" - 22 ½")	157MM	\$50
	Additional Options		
	• Anti Static (Available in fabric and vinyl only)	ANTISTATIC	\$103
• Class 100 Cleanroom ‡	CRPACK	\$141	

◆ **IC plus Upholstery Solution** is tough against high traffic abuse that furniture takes in today's healthcare facilities. IC plus offers an abrasion rating of 1,000,000 double rubs. It is PVC-free, latex free and is guaranteed not to crack, puncture or tear for 10 years. IC plus offers superior cleanability, standing up to all cleaning agents including, but not limited to, Rescue, bleach, CaviCide, Wex-Cide, and Virox 5. This allows cleaning staff to efficiently and effectively remove pathogens from the surface of the chair. Proprietary to ergoCentric, IC plus Upholstery Solution is non-porous and seamless, making microbial growth virtually non-existent. The tough upholstery is strong enough to stand up to any hospital grade cleaner or disinfectant and has been tested to be 750% more resistant to puncturing and 1,000% more resistant to tearing than common hospital grade vinyl.

Ind F Series

Standard when backrest is upholstered in vinyl, PVC-free (vinyl-like) and and IC plus upholsteries

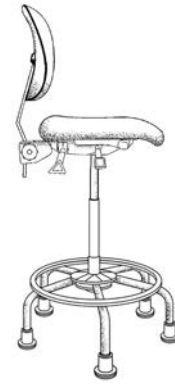
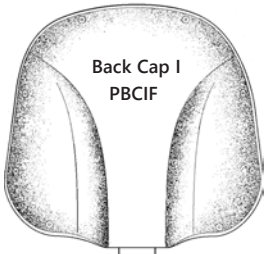

RECOMMENDED ARMS



For specifications, illustrations and additional arm options, see pages 69-71.

SEAT SIZE OPTIONS

- Extra Small XSS** N/C (17 ½"w x 15 ½"d)
- Large LS** \$51 (20"w x 19"d)
- Plus Size PS** \$92 (22"w x 19"d)
- Extra Long XLS** \$92 (20"w x 21"d)
- Extra Deep XPS** \$92 (22"w x 21"d)

- ▲ 7 ½" of pneumatic height adjustment
- * Adds 1 ½" to seat height
- ‡ Only available in vinyl
- ◆ IC plus only available on the back with the Back Cap.

LIST PRICE	List Price	IND. SF STANDARD	IND. LF STANDARD
	• Grade 1		\$1,082
• Grade 2		\$1,112	\$1,171
• Grade 3		\$1,142	\$1,201
• Grade 4		\$1,172	\$1,231
• Grade 5		\$1,202	\$1,261
• Grade 12 / IC plus ◆		\$1,412	\$1,471
• Black Back Cap Standard with Vinyl, PVC-free (vinyl-like), or IC plus Upholsteries	PBCIV	(\$17)	(\$17)

STANDARD SPECIFICATIONS	Backrest	IND. SF STANDARD	IND. LF STANDARD
	• Fully Upholstered Dual Curve Backrest		15 ½"w x 13 ½"h
Seat			
• Dual Density Molded Polyurethane Foam		•	•
• Seat Pan		18 ½"w x 17"d	18 ½"w x 17"d
Standard Mechanism			
• Back Height Adjustment		•	•
• Back Angle Adjustment		•	•
• Back Pivot		•	•
Pneumatic Lift			
• 200 mm Knurled Pneumatic Lift, Dual Height Adjustment System (seat height)		21"-33 ½"▲	21"-33 ½"▲
Base			
• 22" Chrome Base with 18" Round Tube Footring (8 ½" footring height)		•	N/A
• 24" Chrome Base with 20" Round Tube Footring (8 ½" footring height)		N/A	•
• Footrests (height)		(7", 9 ½")	(7", 9 ½")
• Dual Wheel Urethane Casters		•	•
Measurements			
• Boxed Weight/Size		40 lbs/6.7 cu.ft	42 lbs/6.7 cu.ft

OPTIONS	Seat	Upcharge	IND. SF STANDARD	IND. LF STANDARD
	• Energy Absorbant Memory Foam	EA	\$92	•
• Triple Density Foam (adds ¼" to seat width & depth)	TDF	\$76	•	•
Base/Glides/Casters				
• ½" Industrial Glides	HG	N/C	•	•
• 2 ¼" Glides*	2G	N/C	•	•
• Lock On Urethane Casters*	LON	\$188	•	•
• Lock Off Urethane Casters*	LOF	\$89	•	•
• Dual Wheel Nylon Casters*	NC	N/C	•	•
• Single Wheel Nylon Casters*	SW	\$74	•	•
• Single Wheel Urethane Casters*	SWU	\$82	•	•
Additional Options				
• Tilt 2 Mechanism	TILT2	\$50	•	•
• APT Mechanism	APT	(\$38)	•	•
• Anti Static (Available in fabric and vinyl only)	ANTISTATIC	\$175	•	•
• Back Trim	BT	N/C	•	•
• Back Cap I - Fabric Upholstery	PBCIF	N/C	•	•
• Class 100 Cleanroom‡	CRPACK	\$141	•	•

Ind 2F Series

Standard when backrest is upholstered in vinyl, PVC-free (vinyl-like) and IC plus upholsteries

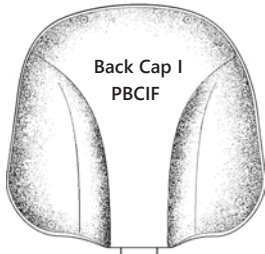

RECOMMENDED ARMS



3" Adjustable T-Arm
3ATAOT \$208

For specifications, illustrations and additional arm options, see pages 69-71.

SEAT SIZE OPTIONS

Extra Small XSS N/C
(17 ½" w x 15 ½" d)

Small SS \$92
(18 ½" w x 17" d)

Plus Size PS \$92
(22" w x 19" d)

Extra Long XLS \$92
(20" w x 21" d)

Extra Deep XPS \$92
(22" w x 21" d)

For graded upholstery choices see page 78.

▲ 7 ½" of pneumatic height adjustment

* Adds 1 ½" to seat height

‡ Only available in vinyl

◆ IC plus only available on the back with the Back Cap.



LIST PRICE	List Price	IND. S2F TILT	IND. L2F TILT
	• Grade 1		\$1,212
• Grade 2		\$1,247	\$1,312
• Grade 3		\$1,282	\$1,347
• Grade 4		\$1,317	\$1,382
• Grade 5		\$1,352	\$1,417
• Grade 12 / IC plus ◆		\$1,597	\$1,662
• Black Back Cap Standard with Vinyl, PVC-free (vinyl-like), or IC plus Upholsteries	PBCIV	(\$17)	(\$17)

STANDARD SPECIFICATIONS	Backrest	IND. S2F TILT	IND. L2F TILT
	• Fully Upholstered Dual Curve Backrest	17" w x 19" h	17" w x 19" h
Seat			
• Dual Density Molded Polyurethane Foam	•	•	
• Seat Pan	20" w x 19" d	20" w x 19" d	
Tilt 2 Mechanism			
• Back Height Adjustment	•	•	
• Back Angle Adjustment	•	•	
• Seat Tilt	•	•	
Pneumatic Lift			
• 200 mm Knurled Pneumatic Lift, Dual Height Adjustment System (seat height)	21"-33 ½"▲	21"-33 ½"▲	
Base			
• 22" Chrome Base with 18" Round Tube Footring (8 ½" footring height)	•	N/A	
• 24" Chrome Base with 20" Round Tube Footring (8 ½" footring height)	N/A	•	
• Dual Wheel Urethane Casters*	•	•	
Measurements			
• Boxed Weight/Size	40 lbs/6.7 cu.ft	42 lbs/6.7 cu.ft	

OPTIONS	Seat	Upcharge	IND. S2F TILT	IND. L2F TILT
	• Energy Absorbant Memory Foam	EA	\$92	•
• Triple Density Foam (adds ¼" to seat width & depth)	TDF	\$76	•	•
Base/Glides/Casters				
• ½" Industrial Glides	HG	N/C	•	•
• 2 ¼" Glides*	2G	N/C	•	•
• Lock On Urethane Casters*	LON	\$188	•	•
• Lock Off Urethane Casters*	LOF	\$89	•	•
• Dual Wheel Nylon Casters*	NC	N/C	•	•
• Single Wheel Nylon Casters*	SW	\$74	•	•
• Single Wheel Urethane Casters*	SWU	\$82	•	•
Additional Options				
• Anti Static (Available in fabric and vinyl only)	ANTISTATIC	\$227	•	•
• Back Trim	BT	N/C	•	•
• Back Cap II - Fabric Upholstery	PBCIIF	N/C	•	•
• Class 100 Cleanroom‡	CRPACK	\$141	•	•



ARMS

Height Adjustable

TC ARMREST - TCENTRIC 4" HEIGHT ADJUSTABLE

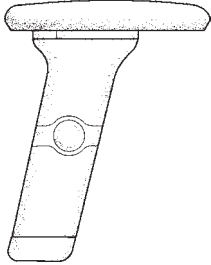

		LIST PRICE
SPECIFICATIONS	<ul style="list-style-type: none"> Cushioned finger tip adjustment Solid ¼" thick spring steel frame, epoxy powder coated black Arms width adjustable 2" per arm Arm height adjustable from seat pan 5 ¾" - 9 ¾" Arm pad: Polyurethane arm pad 5" w x 10" l 	TC \$379
	Arm pads	UPCHARGE
OPTIONS	<ul style="list-style-type: none"> Light Grey tCentric height adjustable armrest 	TCG \$420

4ATAOT ARMREST - 4" HEIGHT ADJUSTABLE

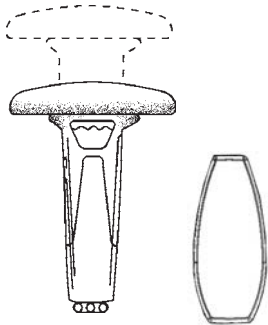

		LIST PRICE
SPECIFICATIONS	<ul style="list-style-type: none"> Finger trigger adjustment Solid ¼" thick spring steel frame, epoxy powder coated black Arms width adjustable 2" per arm Arm height adjustable from seat pan 5 ¼"-9 ¼" Arm pad: Polyurethane oval tube arm cap 4 ¼"w x 10 ½"l 	4ATAOT \$317
	Arm pads	UPCHARGE
OPTIONS	<ul style="list-style-type: none"> Oval tube polyurethane short arm pad 4 ¼"w x 9"l 	4ATAOTSH \$332
	Bracket	
	<ul style="list-style-type: none"> 1" Lower arm 	EDD \$33
	<ul style="list-style-type: none"> 2" Higher arm 	NDD \$33

3ATAOT ARMREST - 3" HEIGHT ADJUSTABLE

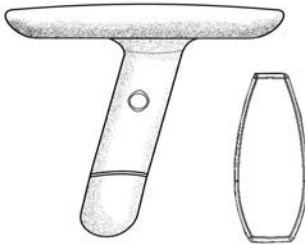

		LIST PRICE
SPECIFICATIONS	<ul style="list-style-type: none"> Finger tip adjustment Solid ¼" thick spring steel frame, epoxy powder coated black Arms width adjustable 2" per arm Arm height adjustable from seat pan 6"-9" Oval tube polyurethane arm pad 4 ¼"w x 10 ½"l 	3ATAOT \$208
	Arm pads	UPCHARGE
OPTIONS	<ul style="list-style-type: none"> Short polyurethane arm pad 4 ¼" w x 9"l 	3ATAOTSH \$208
	<ul style="list-style-type: none"> Oval upholstered arm pad 5 ¼" w x 10"l 	3ATAOV \$248

SATAOT ARMREST - SWING AWAY, HEIGHT ADJUSTABLE

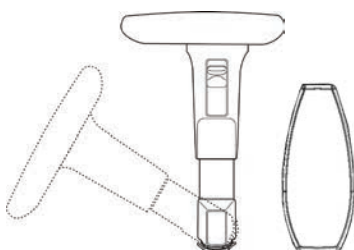

		LIST PRICE
SPECIFICATIONS	<ul style="list-style-type: none"> Finger trigger adjustment Swing away, finger adjustment Solid ¼" thick steel frame, epoxy powder coated black Arms width adjustable 2" per arm Arm height adjustment from seat pan 7 ¾" – 10 ½" Arm pad: Polyurethane oval tube arm cap 4 ½"w x 10 ½"l 	SATAOT \$399
	<ul style="list-style-type: none"> See pages 109-110 for optional upholstered arm pads 	
	<ul style="list-style-type: none"> ESD (available for the Ergo 2F ESD) 	SATAESD \$425

Height & Swivel Adjustable

TC360 ARMREST - TCENTRIC HEIGHT & SWIVEL ADJUSTABLE

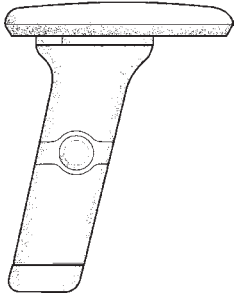

		LIST PRICE	
SPECIFICATIONS	<ul style="list-style-type: none"> Cushioned finger tip adjustment Proprietary swivel adjustment rotates 360° > When rotated 180° the forearm pad moves 2" forward Solid ¼" thick spring steel frame, epoxy powder coated black Arms width adjustable 2" per arm Arm height adjustable from seat pan 5 ¾"-9 ¾" Arm pad: Polyurethane arm pad 5" w x 10" l 	TC360	\$509
	Options		
OPTIONS	Arm pad & colour <ul style="list-style-type: none"> tCentric small arm pad 3 ¾" w x 10" l 	TC360SM	\$509
	<ul style="list-style-type: none"> Light Grey tCentric height & swivel adjustable armrest 	TC360G	\$526

SWV ARMREST- HEIGHT & SWIVEL ADJUSTABLE

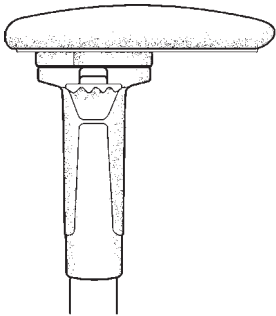

		LIST PRICE	
SPECIFICATIONS	<ul style="list-style-type: none"> Finger trigger adjustment Proprietary swivel adjustment rotates 360° > When rotated 180° the forearm pad moves 2" forward Solid ¼" thick spring steel frame, epoxy powder coated black Arms width adjustable 2" per arm Arm height adjustable from seat pan 6 ¼"-10 ¼" Arm pad: Oval Black Destiny upholstered padded arm pad 5 ¼"w x 10"l 	SWV	\$476
	Options		
OPTIONS	Arm pads <ul style="list-style-type: none"> Oval tube polyurethane 4 ¼" w x 10 ⅝"l when rotated 180° the arm pad moves 3" forward Oval tube polyurethane short arm pad 4 ¼"w x 9"l > when rotated 180° the arm pad moves 1 ½" forward 	SWVOT	\$405
		SWVOTSH*	\$405
Bracket			
	<ul style="list-style-type: none"> 1" Lower arm 2" Higher arm 	EDD	\$33
		NDD	\$33

*Recommended for use on myCentric Series

3SWVOT ARMREST - 3" HEIGHT & SWIVEL ADJUSTABLE

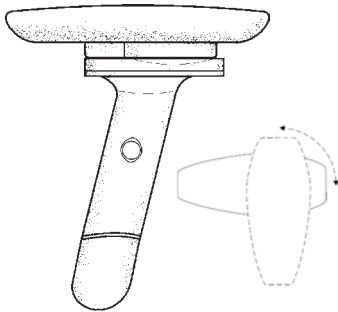

		LIST PRICE	
SPECIFICATIONS	<ul style="list-style-type: none"> Finger tip adjustment Proprietary swivel adjustment rotates 360° > When rotated 180° the forearm pad moves 3" forward Solid ¼" thick spring steel frame, epoxy powder coated black Arms width adjustable 2" per arm Arm height adjustable from seat pan 6 ¾"-9 ¾" Arm cap: Oval tube polyurethane arm pad 4 ¼" w x 10 ⅝"l 	3SWVOT	\$335
	Options		
OPTIONS	<ul style="list-style-type: none"> Short polyurethane arm pad 4 ¼"w x 9"l* > When rotated 180° the forearm pad moves 1 ½" forward 	3SWVOTSH*	\$335

*Recommended for use on myCentric Series

Height & Lateral

TCL ARMREST- TCENTRIC HEIGHT & LATERAL ADJUSTABLE

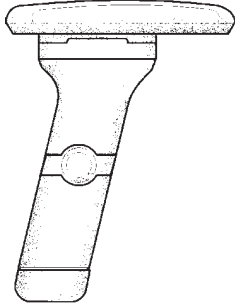

		LIST PRICE
SPECIFICATIONS	<ul style="list-style-type: none"> Cushioned finger tip adjustment Arm lateral adjustment 2 ½" inwards Solid ¼" thick spring steel frame, epoxy powder coated black Arms width adjustable 2" per arm Arm height adjustable from seat pan 5 ¾" - 9 ¾" Arm pad: Polyurethane arm pad 5"w x 10" l 	TCL \$509
	Arm pad & colour	LIST PRICE
OPTIONS	<ul style="list-style-type: none"> tCentric small arm pad 3 ¾" w x 10" l 	TCLSM \$526
	<ul style="list-style-type: none"> Light Grey tCentric height & lateral adjustable armrest 	TCLG \$524

Height, Lateral & Swivel

TCL360 ARMREST – TCENTRIC HEIGHT, SWIVEL & LATERAL ADJUSTABLE

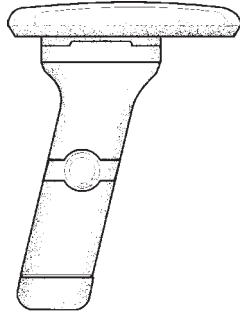

		LIST PRICE
SPECIFICATIONS	<ul style="list-style-type: none"> Cushioned finger tip adjustment Proprietary swivel adjustment rotates 360° > When rotated 180° the forearm pad moves 2" forward Arm lateral adjustment 2 ½" inward Solid ¼" thick spring steel frame, epoxy powder coated black Arms width adjustable 2" per arm Arm height adjustable from seat pan 6 ½" - 10 ½" Arm pad: Polyurethane arm pad 4 ¾"w x 10 ¼" l 	TCL360 \$549
	Arm pad & colour	LIST PRICE
OPTIONS	<ul style="list-style-type: none"> tCentric small arm pad 3 ¾" w x 10" l 	TCL360SM \$549
	<ul style="list-style-type: none"> Light Grey tCentric height, swivel & lateral adjustable armrest 	TCL360G \$565
	<ul style="list-style-type: none"> Midnight Black tCentric armrest with Nytek Black Upholstery 	TCL360UPBL \$549
	<ul style="list-style-type: none"> Light Grey tCentric armrest with Nytek Grey Upholstery 	TCL360UPG \$565



OPTIONS, UPHOLSTERY & PARTS

Adjustable Headrest

AHR - ADJUSTABLE HEADREST

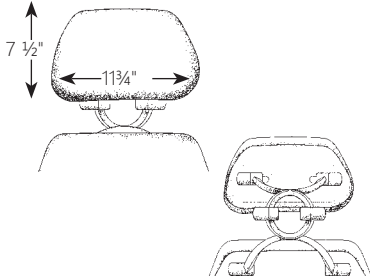

SPECIFICATIONS		
	<ul style="list-style-type: none"> Side stitching offers cushioned support with a tailored look Durable headrest cap has a stylish line pattern Patented headrest bracket has 3 pivot points with 7" vertical and horizontal adjustments to provide the maximum range of adjustability Dampers in pivot mechanisms allow the headrest to be moved to the desired position without loosening 7 1/2"h x 11 3/4"w Convex curve for additional support 	AHR
<ul style="list-style-type: none"> Light grey option 	AHRG	\$506

24Centric & eCentric Executive Series Adjustable Headrest

24AHR - 24CENTRIC AND ECENTRIC EXECUTIVE ADJUSTABLE HEADREST

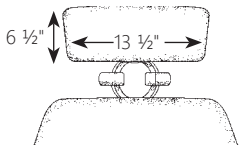

SPECIFICATIONS		
	<ul style="list-style-type: none"> Side stitching of upholstered headrest cap offers cushioned support with a tailored look Patented headrest bracket has 3 pivot points with 7" vertical and horizontal adjustments to provide the maximum range of adjustability Dampers in pivot mechanisms allow the headrest to be moved to the desired position without loosening 6 1/2"h x 13 1/2"w 	24AHR

Leg Rest

LR - LEG REST

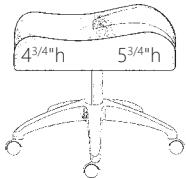

SPECIFICATIONS			
	<ul style="list-style-type: none"> Molded Polyurethane High Resilient Foam for a more cushioned support Two elevation curves for a wider range in height and angle support requirements Valley between elevation curves offers full leg support Easy-to-use ring type height adjustment activator (seat height - 15 1/4"-18") 21" w x 17 1/2" d 360° swivel 24" glass reinforced nylon base 5 dual wheel nylon casters 	LR	\$375
OPTIONS	<ul style="list-style-type: none"> Leg rest tilt mechanism 	TILT	\$189

Footrest

FOOTFLEXOR - ERGOCENTIRC FOOTFLEXOR

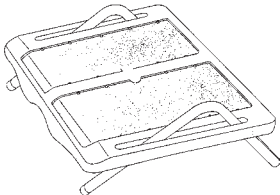

SPECIFICATIONS			
<ul style="list-style-type: none"> • 1 3/4" Laminated MDF footplate • Foot plate height 3 1/2" • Dimensions: 18"w x 11 1/2"d • Inset vinyl non-slip tread, 5/8" diameter chrome plated steel tube rubber non-slip feet • Footplate and tubular frame are one part 	FOOTFLEXOR		\$182
<ul style="list-style-type: none"> • 1 3/4" Laminated MDF footplate • Foot plate height 6" • Dimensions: 18"w x 11 1/2"d • Inset vinyl non-slip tread, 5/8" diameter chrome plated steel tube rubber non-slip feet • Footplate and tubular frame are one part 	TALLFOOTFLEXOR		\$207

Anti-fatigue Mats

AFM - ANTI-FATIGUE MAT

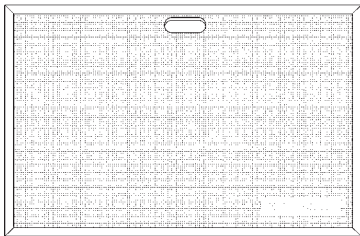



SPECIFICATIONS	<ul style="list-style-type: none"> • Work well in conjunction with standing height, height adjustable workstations, sit stand seating and stools • Non-slip top and bottom with no-trip beveled edge • Safe, non-toxic and latex-free (No PVC or BPAs) • Flame resistant up to 200° C • Dimensions: ¾" thick • Convex curve for additional support • 1 year warranty 		
	Size Options		
OPTIONS	• Anti-Fatigue Mat 18" x 24"	AFM-18x24	\$117
	• Anti-Fatigue Mat 36" x 24"	AFM-36x24	\$194

Casters and Glides

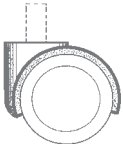
See chair specification pages for availability and pricing

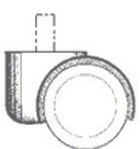
NC - DUAL WHEEL NYLON CASTERS		
	Designed for use on carpeted surfaces.	LIST PRICE
	Features <ul style="list-style-type: none"> • 2" diameter caster with steel stem • Nylon body • Dual nylon wheels 	NC \$11 each

UC - DUAL WHEEL URETHANE CASTERS		
	Designed for use on hard floor, tile, concrete, marble floors.	LIST PRICE
	Features <ul style="list-style-type: none"> • 2" diameter caster with steel stem • Nylon body • Dual polyurethane wheels 	UC \$22 each

LON - LOCK ON URETHANE CASTERS		
	Provides the stability of a glide and mobility of a caster. When the user's weight is on the chair, the wheels lock. With no weight on the chair, the caster unlocks and moves freely.	LIST PRICE
	Features <ul style="list-style-type: none"> • 2 ¼" caster with steel stem • Nylon body • Dual urethane wheels • Brakes 	LON \$53 each

LOF - LOCK OFF URETHANE CASTERS		
	Ideal for use on tile floors. When the user's weight is off the chair, a brake is applied to prevent the chair from rolling away.	LIST PRICE
	Features <ul style="list-style-type: none"> • 2 ¼" Caster with steel stem • Nylon body • Dual nylon wheels • Brakes 	LOF \$34 each

SW - SINGLE WHEEL NYLON CASTERS		
	Designed for use on heavy carpet	LIST PRICE
	Features <ul style="list-style-type: none"> • 2 ½" Caster with steel stem • Steel body • Single nylon wheel 	SW \$32 each

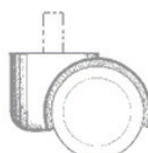
USC - URETHANE STACKER CASTERS		
	Designed for use on hard floors including tile, concrete and marble	LIST PRICE
	Features <ul style="list-style-type: none"> • 1 ½" diameter caster with nylon body • Dual polyurethane wheels 	USC \$30 each

SWU - SINGLE WHEEL URETHANE CASTERS		
	Designed for use on rough floor surfaces.	LIST PRICE
	Features <ul style="list-style-type: none"> • 2 ½" Caster with steel stem • Steel body • Single Urethane wheel 	SWU \$34 each

OMU - SINGLE WHEEL NEOPRENE CASTER		
	Designed for use on rough floor surfaces. Adds 2 ½" to seat height	LIST PRICE
	Features <ul style="list-style-type: none"> • Two options available, 3" or 2" • Steel body • Single urethane wheel 	2" OMC \$50 each 3" OMU \$66 each

NSC - NYLON STACKER CASTER		
	Designed for commercial carpet use	LIST PRICE
	Features <ul style="list-style-type: none"> • 1 ½" diameter caster with nylon body • Dual nylon wheels 	NSC \$26 each

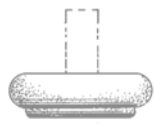
INDUSTRIAL GLIDE		
	Provide stability for use on commercial carpet and floors.	LIST PRICE
	Features <ul style="list-style-type: none"> • ½" (flat) glides HG 	HG \$10 each

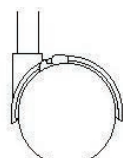
CAC - SILVER ACCENT CASTERS		
	Designed for use on carpet	LIST PRICE
	Features <ul style="list-style-type: none"> • 2" diameter caster with steel stem • Silver Accent Middle body • Dual nylon wheels 	CAC \$24 each

GLIDES		
	Provide stability for use on commercial carpet and floors.	LIST PRICE
	Features <ul style="list-style-type: none"> • 1 ¼" glides 1G • 2 ¼" glides 2G 	1G \$11 each 2G \$11 each

Seat dimensions

Please see below for our range of seat sizes.

SEAT SIZE						
Chair Series	Extra Small	Small	Large/ Standard	Plus Size	Extra Long	Extra Deep
tCentric Hybrid™ Mesh Seat	–	20"w x 16 ½"d TMBMSS/TLGMSS	21"w x 18 ½"d TMBMS/TLGMS	–	21"w x 21 ½"d TMBMXLS/ TLGMXLS	–
tCentric Hybrid™	17 ½"w x 15 ½"d XSS	18 ½"w x 17"d SS	20"w x 19"d LS	22"w x 19"d PS	20"w x 21"d XLS	22"w x 21"d XPS
airCentric™	17 ½"w x 15 ½"d XSS	18 ½"w x 17"d SS	20"w x 19"d LS	22"w x 19"d PS	20"w x 21"d XLS	22"w x 21"d XPS
Saffron / Saffron R	17 ½"w x 15 ½"d XSS	18 ½"w x 17"d SS	20"w x 19"d LS	22"w x 19"d PS	20"w x 21"d XLS	22"w x 21"d XPS
geoCentric™	17 ½"w x 15 ½"d XSS	18 ½"w x 17"d SS	20"w x 19"d LS	22"w x 19"d PS	20"w x 21"d XLS	22"w x 21"d XPS
ecoCentric™	17 ½"w x 15 ½"d XSS	18 ½"w x 17"d SS	20"w x 19"d LS	22"w x 19"d PS	20"w x 21"d XLS	22"w x 21"d XPS
eCentric™	17 ½"w x 15 ½"d XSS	18 ½"w x 17"d SS	20"w x 19"d LS	22"w x 19"d PS	20"w x 21"d XLS	22"w x 21"d XPS
myCentric™	17 ½"w x 15 ½"d XSS	18 ½"w x 17"d SS	20"w x 19"d LS	22"w x 19"d PS	20"w x 21"d XLS	22"w x 21"d XPS
ergoForce™	17 ½"w x 15 ½"d XSS	18 ½"w x 17"d SS	20"w x 19"d LS	22"w x 19"d PS	20"w x 21"d XLS	22"w x 21"d XPS
Specialty Seating	17 ½"w x 15 ½"d XSS	18 ½"w x 17"d SS	20"w x 19"d LS	22"w x 19"d PS	20"w x 21"d XLS	22"w x 21"d XPS
Chair Series	Small	Small Heavy Duty	Large/ Standard	Large Heavy Duty	Plus Size	Extra Wide
eCentric Executive™	20"w x 17"d 24CSS	24"w x 19"d SSHHD	20"w x 19"d 24CSTD	24"w x 21"d LSHD	22"w x 21"d 24CPS	22"w x 19"d 24CXW
24Centric™	20"w x 17"d 24CSS	24"w x 19"d SSHHD	20"w x 19"d 24CSTD	24"w x 21"d LSHD	22"w x 21"d 24CPS	22"w x 19"d 24CXW
Chair Series	Small	Small Heavy Duty	Large/ Standard	Large Heavy Duty	Plus Size	Extra Wide
e500™	–	–	22"w x 21"d 24CPS	24"w x 21"d E5LSHD	–	26"w x 21"d E5XW

ergoCentric Approved Fabrics

ergoCentric Approved Fabrics include upholsteries that have undergone exhaustive review to determine top-selling fabrics, patterns and colours. From there we tested and re-tested the materials to ensure they accentuate the ergonomic function of our seating. It was only after this rigorous process that a fabric was included in the ergoCentric Approved carded program.

All ergoCentric Approved Fabrics:

- Have a 10 year performance warranty
- Allow seating systems to be available in 10 business days
- Ensure the optimal ergonomic seating experience is provided



FABRIC	
GRADE 1	
Air Knit	Punch Card
Open House	
GRADE 3	
Teknit	
GRADE 6	
Nytek	Frixion

OTHER
GRADE 8
Nymatrix
LEATHER
Madras

Leather matches are available in the following colors: Poppy, Aspen, Crimson, Cobblestone, Brownie, Clay, Chocolate, Black, Ginger

Note: For optimal cleanability, non-tailored seats are standard for vinyl upholstery. Tailored vinyl seats are available at an additional cost, but are not recommended. Please contact your sales representative for more information.

Maintenance

Fabrics

Keep clean with regular vacuuming. For spills, absorb as much as possible with a damp cloth, but do not rub. For stains, we recommend professional cleaning.

Vinyl

Clean with soft cloth dampened with mild soap solution. For stains, a sponge or soft brush may be used with mild non-abrasive cleaner.

Leather

Occasional dusting/vacuuming for a more thorough cleaning.

tCentric Hybrid Mesh

To prevent overall soil, frequent vacuuming or light brushing to remove dust and grime is recommended. Spot clean with mild soap and water. The use of bleach is to be avoided; however, a 1:10 bleach solution may be used for infrequent disinfecting when necessitated. The accumulated wet contact time should be limited to a maximum of 2 hours over the life of the chair. Virex can also be used.

Customer's own materials

COM Fabric Instructions

Please provide us with the required information listed below and we will confirm if there is the need for testing. Approved COM and samples for testing, if required, must be sent to your Customer Service Representative at 275 Superior Blvd. Mississauga, ON, Canada L5T 2L6 in accordance with the COM terms as described on page 5. Please contact Customer Service for special shipping instructions.

For both Hassle Free and Traditional COM orders, we require the following information with your purchase order to provide accurate customer service and order fulfillment:

- Fabric supplier or mill
- Fabric description
- Name
- Number
- Colour Pattern
- Any special application details
- Pattern orientation
- Fabric selection by application (inner or outer back for example)

Note: For all seating lines with separate seats and backs we offer the no-charge option of specifying different fabric colours for inner or outer backs and seats.

All COM orders are subject to the Terms and Conditions of Sale; CUSTOMERS OWN MATERIAL as appropriate.

Sales and service

ergoCentric Seating Systems
275 Superior Blvd., Mississauga, Ontario L5T 2L6
ph: 1 866 GET ERGO | 905 696-6800
fx: 1 800 848-5190 | 905 696-0899

ergocentric.com
service@ergocentric.com

Sales support

For a current list of our
sales support staff, please visit:
ergocentric.com/reps

Authorized dealers

For a current list of our
authorized dealers, please visit:
ergocentric.com/government

ergoCentric®

ph: 1 866 GET ERGO | 905 696-7400
fx: 1 800 848-5190 | 905 696-0899
orders@ergocentric.com
ergocentric.com



ergoCentric®, tCentric Hybrid™, airCentric™, geoCentric™, eCentric™, myCentric™, ecoCentric™, iCentric™, ergoForce™, 24Centric™ and The science of sitting™ are registered trademarks of ergoCentric Inc. All other trademarks, registered trademarks and logos are the property of their respective owners.